

MSC → DA - 0 - 68 - 1

Comprehensive Biological Protocol  
for the  
Lunar Sample Receiving Laboratory  
Manned Spacecraft Center  
National Aeronautics and Space Administration  
Houston, Texas

Prepared under Contract NAS 9-6157  
to  
Baylor University College of Medicine, Houston, Texas

Submitted June 16, 1967

## INTRODUCTORY STATEMENT

In June, 1966, members of the scientific community of the Baylor University College of Medicine contracted to prepare a biological quarantine protocol for the safe handling and study of lunar material to be returned to earth from early Apollo missions--such material, the spacecraft, and crew to be isolated initially in the Lunar Receiving Laboratory, Manned Spacecraft Center, National Aeronautics and Space Administration, Houston, Texas. This document, and its abbreviated operational counterpart, written under contract NAS-9-6157, constitute a final protocol which has been modified extensively from a preliminary document submitted on December 16, 1966.

The goals of the Lunar Receiving Laboratory are multiple and broadly encompass the scientific disciplines of geology, geophysics, chemistry, and biology. The purpose of this protocol is to define the biological studies which might reasonably fulfill the goals of the Bioscience Working Group of the Manned Space Science Coordinating Committee, as set forth here:

The prime purpose of the laboratory would be to provide a formal mechanism for testing appropriate representative lunar samples for the possible presence of agents that might be infectious or toxic for man, animals, and plants. It should be the goal of this laboratory to provide safety clearance for lunar samples, if possible, within a period of approximately 30 days.

--National Aeronautics and Space Administration:  
Summer Conference on Lunar Exploration and  
Science, NASA-SP-88, p. 234, July, 1965.

An overall statement of policy has been published recently (Science 155: 525, Feb. 3, 1967) and is appended to this document. In preparing

a protocol which would fulfill these goals, we have had the benefit of the wise and introspective counsel of many contributors, and the guidelines set forth here reflect the judgment of a cross section of our national scientific community. The protocol, while broad in scope, attempts to explore in depth the effect of the lunar material upon plant and animal species about which a great deal is already known.

The protocol is flexible and lends itself to easy revision as more information is accumulated concerning the lunar sample and as biological techniques improve during the implementation of the laboratory.

The biological protocol has three main elements, the first being crew microbiology; the second, in vitro attempts to culture microorganisms from the lunar sample; and the third, the direct challenge of the lunar sample in biological systems. Crew microbiology concerns itself with the establishment of pre-flight microbiology profiles and the subsequent review of alterations in flora encountered in crew personnel following return to earth. These studies will be performed in quarantine areas of the Lunar Receiving Laboratory and will be limited in duration to the time required to establish the nature of the microbial burden carried by the crew and the assurance of their freedom from communicable disease.

Since it will be impossible to test the lunar sample on all but a few earth species, portions of the sample will be tested in representative members of all major taxa. We have utilized the concept of "unity within diversity" of biological processes on earth, and the careful selection of certain key species by the scientific community provides a broad-based spectrum for testing purposes. There exists a small but finite

probability that lunar substances may be injurious to organisms on earth. Such biological injury may be due to an inherent toxicity of the material or to the capability of such material to propagate itself in earth species.

The toxic materials may be classified as follows:

- a. Radioactive materials from the moon itself. Early studies within the Lunar Receiving Laboratory will explore this possibility.
- b. Unknown inorganic polymers possibly containing silica, boron, and other inorganic elements.
- c. Deleterious low-molecular-weight compounds acting as cellular and metabolic poisons, mutagens, irritants, antimetabolites, or anti-vitamins.
- d. Unknown metallo-organic compounds, effects on terrestrial organisms unknown.

The replicative materials may be classified as follows:

- a. Organisms (viral, bacterial, or fungal) taken to the moon, subjected to high-incident radiation, and returned unwittingly to earth. Such organisms may have mutated and have no counterpart on earth. This is an unlikely event.
- b. Plant materials of lunar origin capable of reproducing on earth as autotrophs or heterotrophs in nutrient media (artificial or natural, as in soil, ponds, oceans), resulting in naturalized forms producing deleterious effects by contact or competition.
- c. Xerophilic life forms of lunar origin using as protoplasmic materials elements found in terrestrial organisms such as carbon, hydrogen, oxygen, sulfur, and phosphorus.



- d. The existence of living matter on the moon at an organizational level above that of the small metazoa or metaphytes has a probability considerably less than that for unicellular organisms and is virtually excluded from consideration.

If one accepts these fundamental policies and the constraints imposed upon the laboratory by space and time limitations, there are left only three points which deserve discussion here in the way of clarification. These are the philosophy of the testing process itself, the nature of the internal controls to be employed, and the statistical approach to an evaluation of a heterogeneous, unknown mixture whose toxic or microbiological potential is unknown.

In regard to the philosophy of the testing procedures, it is safe to say that never before has there existed a facility with such ambitious and demanding goals as those presented by the Lunar Receiving Laboratory. The committee responsible for the preparation of this protocol stresses the need, therefore, for high professional standards in the conduct of these studies and has encouraged the Space Agency to avail themselves of the vast technical competence existing in laboratories throughout this country. When possible, it is to be hoped that the Agency will employ outside consultation at all steps. A testing procedure of this magnitude and scope demands a degree of supervision and insight which will be challenging in the extreme.

Since the testing procedures can be no better than the skill of those employing them, and in view of the diversity of species selected here, it is anticipated that the laboratory management will utilize to



the fullest the sound and competent advice of the academic community and those federal agencies (U.S. Department of the Interior, U.S. Department of Agriculture, U.S. Public Health Service) which have been instrumental in establishing the need for this laboratory.

An important point which the committee would stress concerns the sequence of events in handling the lunar material. Collection, transport, receipt, and opening of the sample, as well as its mixing, aliquoting, and distribution, constitute a part of the general introduction to this protocol. In microbiological testing, however, it will be noted that we have set up a series of "challenges" to host organisms, this group of hosts representing higher and lower vertebrates, invertebrates, unicellular organisms and plants. It is anticipated that, along with the initial in vivo challenge and in vitro studies using classic microbiologic techniques, parallel in vitro challenges will be made to both animal and plant cells growing in tissue culture. These "observational" steps are to be followed by a secondary in vivo challenge as well as in vitro classic microbiological techniques, using organic and inorganic media containing such added nutrients as might be suggested by the initial elemental and organic analysis of the lunar sample. This temporal order, of initial followed by secondary challenges, constitutes the critical part of the microbiological protocol. If replicating forms exist, this sequence offers the greatest promise for their detection.

Every system described in this protocol has as an internal control the requirement that direct challenge of in vivo systems be conducted with both untreated and sterilized lunar material. Absolute double-barrier techniques

are to be used throughout the laboratory; in some cases specific pathogen-free or germ-free species will be used, and in all in vitro systems absolute sterility of the system is mandatory. Carefully controlled trial runs of all systems should be begun fully one year in advance of receipt of the first lunar sample, and "unknown" terrestrial soil samples should be carried through all systems to insure the technical competence of the laboratory facility.

Since no one can predict at this time whether or not the lunar sample will be harmful to biological systems on earth, it is impossible to predict precisely how much material will be required to carry out the testing procedures outlined here. In such a sea of ignorance, we have had to rely upon an almost empiric statistical approach, which can provide answers only on a contingency basis. We have had to assume, therefore, that the lunar sample, if it contains microorganisms at all, contains them at very low concentrations. From such a base, we have used the next assumption, that these low concentrations exist either at "near negligible" or at "detectable" levels. Such assumptions have allowed us to estimate a high and low quantity of material to be employed in many of the various direct in vivo challenges. In certain smaller species, such calculations cannot be used, since one is limited in the net amount of material which the species can tolerate. Such decisions will be difficult at best, and, again, the judgment of those working in the field has been used as the ultimate guideline.

Our contributors who have reviewed the preliminary document have pointed out that in many areas the protocol lacks depth, that certain key species have been omitted, that in some areas the protocol is too extensive, that it is impossible to do definitive studies on such impure mixtures, that the

testing procedures are often empiric and of too short a duration, and a host of other valid objections. The committee feels obliged to point out the constraints imposed by the definition of a quarantine laboratory. We have been forced to adopt the dictum that the work of the laboratory is aimed only at short-term, time-critical, analytical procedures and identification of whether or not the lunar sample constitutes a threat to our terrestrial biosphere. All other considerations become secondary. Within this frame of reference, most of the criticisms to which we have given our serious consideration become invalid.

## ACKNOWLEDGMENTS

The committee responsible for organizing the material presented here has profited from the wise counsel of many consultants and contributors. Those who have presented formal protocols which have been incorporated into this document are listed here:

Doctor Klaus Bieman - Massachusetts Institute of Technology  
Doctor George W. Brown - University of Washington  
Doctor A.N. Burlingame - University of California at Berkeley  
Doctor Roy E. Cameron - Jet Propulsion Laboratory  
Doctor James W. Campbell - Rice University  
Doctor Robert Couch - Baylor University College of Medicine  
Doctor Gordon Douglas - Baylor University College of Medicine  
Doctor Lorraine Gall - IBM Corporation  
Doctor Werner Janssen - Army Biological Center, Fort Detrick, Maryland  
Doctor Donald L. Lindsey - Colorado State University  
Doctor Mauro E. Martignoni - U.S. Dept. of Agriculture, Corvallis, Oregon  
Doctor G. Briggs Phillips - Becton, Dickinson & Company  
Doctor Stuart Riggs - Baylor University College of Medicine  
Doctor John E. Simmons, Jr. - University of California at Berkeley  
Doctor S. Venkateswaren - University of Houston  
Mr. Craig Wallis - Baylor University College of Medicine  
Doctor Marguerite Webb - Goucher College  
Doctor Darrell Weber - University of Houston  
Doctor Robert Williams - Baylor University College of Medicine

In addition, valuable suggestions have resulted from protocol review discussions, and seminars with the following individuals:

Doctor Libero Ajello - Communicable Disease Center, Atlanta, Georgia  
Doctor Edgar Altenburg - Rice University  
Doctor William Balamuth - University of California at Berkeley  
Doctor Samuel H. Black - Baylor University College of Medicine  
Doctor John Bleby - Medical Research Council, Surrey, England  
Doctor Maurice Bloodworth - Texas A&M University  
Doctor James Bonner - California Institute of Technology  
Doctor William L. Boyd - Colorado State University  
Doctor Frank Brown, Jr. - Northwestern University  
Doctor Luolin S. Browning - Rice University  
Doctor Greig Butterworth - IBM Corporation  
Doctor William B. Cherry - Communicable Disease Center, Atlanta, Georgia  
Doctor Norman F. Conant - Duke University Medical Center  
Doctor Charles Curtis - Ames Research Center  
Lt. Col. Irving Davis - Brooks Air Force Base  
Doctor W.H. Ewing - Communicable Disease Center, Atlanta, Georgia  
Doctor Willson Fahlberg - Baylor University College of Medicine  
Doctor Donald S. Farner - University of Washington  
Doctor Eugene Goldschmidt - University of Houston  
Doctor Leon Goldstein - Harvard University Medical School  
Doctor Chauncey Goodchild - Emory University

Doctor Frank Hardy - Hardy Products, Kansas City  
 Doctor William A. Hill - Baylor University College of Medicine  
 Doctor Evan Horning - Baylor University College of Medicine  
 Mr. Lewis Hornung - Difco Laboratories  
 Doctor J. R. Howes - Auburn University  
 Doctor Sarah Huggins - University of Houston  
 Doctor William S. Jordan, Jr. - University of Virginia School of Medicine  
 Doctor Arthur Kelman - University of Wisconsin  
 Doctor Michael Kennedy - Dow Chemical Company  
 Doctor Harold P. Klein - Ames Research Center  
 Doctor Alan Kohn - University of Washington  
 Doctor George W. Kunze - Texas A&M University  
 Doctor Jack Luick - University of Alaska  
 Doctor James McCloskey - Baylor University College of Medicine  
 Doctor Stanley Marcus - University of Utah College of Medicine  
 Doctor Arthur W. Martin - University of Washington  
 Doctor Guy Mattson - Dow Chemical Company  
 Mr. Paul Maupin - Dow Chemical Company  
 Doctor Edward Merek - Ames Research Center  
 Doctor George H. Meyer - University of Texas at Austin  
 Doctor Peter R. Morrison - University of Alaska  
 Doctor James E. Moyer - U.S. Department of Interior  
 Doctor C.R. Paalanen - University of Pittsburgh  
 Mr. Manning Price - Texas A&M University  
 Doctor Robert L. Rausch - Arctic Health Research Center, Anchorage, Alaska  
 Doctor John Robertsen - Dow Chemical Company  
 Doctor Roslyn Q. Robinson - Communicable Disease Center, Atlanta, Georgia  
 Doctor Knut Schmidt-Nielsen - Duke University  
 Doctor Earl Segal - San Fernando Valley State College  
 Doctor John E. Simmons - University of California at Berkeley  
 Doctor S.F. Snieszko - U.S. Department of Interior  
 Doctor Richard Starr - Indiana University  
 Doctor Edward Steinhaus - University of California, Irvine  
 Doctor Ian M. Sussex - Yale University  
 Doctor Alfred S. Sussman - University of Michigan  
 Doctor William A. Taber - Texas A&M University  
 Doctor K.V. Thimann - University of California, Santa Cruz  
 Doctor John Trentin - Baylor University College of Medicine  
 Doctor Wolf Vishniac - University of Rochester  
 Doctor Benjamin Volcani - Scripps Oceanographic Institute  
 Doctor Martha K. Ward - U.S. Army Medical Unit, Fort Detrick, Maryland  
 Mr. Reuben Wende - City Health Laboratory, Houston, Texas  
 Doctor Kenneth E. Wolf - U.S. Department of Interior  
 Doctor Albert Wolfson - Northwestern University  
 Doctor Val Woodward - University of Minnesota  
 Doctor Orville Wyss - University of Texas at Austin  
 Doctor Richard Young - Ames Research Center  
 Doctor R. Keith Zeigler - Texas Institute for Rehabilitation and Research  
 Doctor L.P. Zill - Ames Research Center

Many useful discussions were held with intramural personnel of the Manned Spacecraft Center. Our Technical Monitor, Doctor William Kemmerer, and the Interagency Liaison Officer, Doctor Briggs Phillips, were of prime

importance in the preparation of the document. Doctor Elbert King contributed profitable discussions concerning the lunar environment.

Finally, the secretarial and editorial assistance of Mrs. Rosa Elena Caffarena, Mrs. Barbara Dalton, Mrs. Sara Corcoran, Mr. Marc Levine, Mr. David Ott, Miss Eileen Stilson, Miss Carol Vaughan, Mr. Gary White, and Carol Jane Wilson, M.D., is gratefully acknowledged.

Bonnalie O. Campbell, Ph.D.  
Baylor University College of Medicine

Millicent C. Goldschmidt, Ph.D.  
Baylor University College of Medicine

Harry S. Lipscomb, M.D.  
Baylor University College of Medicine

J. Vernon Knight, M.D.  
Baylor University College of Medicine

Joseph L. Melnick, Ph.D.  
Baylor University College of Medicine

## CONTENTS

	<u>Page</u>
INTRODUCTORY STATEMENT-----	ii
ACKNOWLEDGMENTS-----	ix
CONTAINMENT-----	1
Personnel and Equipment-----	2
Lunar Sample Containment Procedures-----	3
PRELIMINARY SEARCH FOR ORGANIC COMPOUNDS BY MEANS OF MASS SPECTROMETRY-----	12
Method of Investigation-----	15
Sample Transfer into the Mass Spectrometer-----	17
Personnel Requirements-----	18
Distribution and Interpretation of Raw Data-----	18
Space Requirements-----	19
MICROBIOLOGICAL PROFILES-----	21
Crew and Environment Microbiology-----	22
Protocols for the Recovery of Microorganisms from the Crew-----	23
Pre-Flight Testing Procedures-----	23
Bacteria-----	23
Treponemes-----	44
Mycoplasma-----	46
Fungi and Actinomycetes-----	49
Protozoa and Helminths-----	51
Viruses-----	55



	<u>Page</u>
Post-flight Testing Procedures -----	70
Microbiology -----	70
Virology -----	71
Protocols for the Recovery of Microorganisms from the Environment -----	74
Pre-Flight Testing Procedures -----	74
Post-Flight Testing Procedures -----	83
LUNAR SAMPLE TESTING -----	84
General Recommendations -----	85
Control Testing -----	87
Protocols for the Recovery of Microorganisms from the Lunar Sample -----	91
Culturing Procedures -----	91
Secondary Culturing Procedures -----	96
Bacteria -----	101
Algae -----	116
Fungi and Actinomycetes -----	119
Protozoa -----	123
Viruses -----	125
ANIMAL AND PLANT CHALLENGE -----	128
Invertebrate Flow Sheet -----	129
Vertebrate Flow Sheet -----	130
Invertebrate and Protochordate Animal Schema - Priority Testing---	131
Invertebrate Schema - Additional Species of High Priority -----	133
Vertebrate Schema - Priority Testing -----	134
Vertebrate Schema - Additional Species of High Priority -----	135
Species Selection -----	136

	<u>Page</u>
Control Testing-----	137
Methods of Exposure-----	138
Sample Size Used in Exposures-----	139
Solutions-----	140
ANIMAL CHALLENGE-----	142
General Instructions-----	143
Testing-----	145
Assessment of the Effect of Exposure to Sample Materials-----	147
Histology-----	149
Secondary Challenge-----	150
Attempts to Culture Microorganisms-----	151
INVERTEBRATE CHALLENGE-----	152
VERTEBRATE CHALLENGE-----	154
PHYLUM PROTOZOA	
CLASS FLAGELLATA (MASTIGOPHORA)	
<u>Euglena gracilis</u> var. <u>bacillaris</u> -----	155
<u>Gonyaulax polyedra</u> -----	157
<u>Trypanosoma</u> ( <u>Schizotropanum</u> ) <u>cruzi</u> -----	159
<u>Trichomonas vaginalis</u> , strain TVC-----	162
CLASS RHIZOPODA (SARCODINA)	
<u>Amoeba proteus</u> -----	163
<u>Entamoeba invadens</u> , strain IP-----	165
<u>Entamoeba histolytica</u> -----	167
CLASS CILIATA	
<u>Paramecium aurelia</u> -----	169
<u>Tetrahymena pyriformis</u> -----	171
<u>Blepharisma undulans</u> -----	173
<u>Balantidium coli</u> -----	175

	<u>Page</u>
COELENTERATA (PHYLUM CNIDARIA AND PHYLUM CTENOPHORA)	
CLASS HYDROZOA	
<u>Pelmatohydra oligactis</u> -----	177
CLASS ANTHOZOA	
<u>Metridium senile</u> -----	180
Coelenterate Tissue Culture-----	181
PHYLUM PLATYHELMINTHES	
CLASS TURBELLARIA	
<u>Dugesia dorotocephala</u> -----	182
CLASS CESTOIDEA	
<u>Hymenolepis diminuta</u> -----	184
ASCHELMINTHES (INCLUDING THE NEMATHELMINTHES)	
CLASS ROTIFERA	
<u>Epiphanes (=Hydatina) senta</u> -----	186
CLASS NEMATODA	
<u>Rhabditis maupasi</u> -----	188
<u>Turbatrix aceti</u> -----	191
<u>Neaplectana glaseri</u> -----	192
PHYLUM ANNELIDA	
CLASS OLIGOCHAETA	
<u>Lumbricus terrestris</u> -----	194
CLASS POLYCHAETA	
<u>Nereis (=Neanthes) virens</u> -----	197
PHYLUM MOLLUSCA	
CLASS AMPHINEURA	
<u>Chaetopleura apiculata</u> or <u>Mopalia sp.</u> -----	199

	<u>Page</u>
CLASS GASTROPODA	
<u>Thais haemastoma</u> -----	201
SUBCLASS OPISTHOBRANCHIA	
<u>Aplysia sp.</u> -----	202
SUBCLASS PULMONATA	
<u>Otala lactea</u> -----	203
<u>Limax flavus</u> -----	206
CLASS BIVALVIA	
<u>Crassostrea virginica</u> -----	207
SUBCLASS LAMELLIBRANCHIA	
<u>Spisula solidissima</u> -----	207
CLASS CEPHALOPODA	
<u>Octopus bimaculatus</u> -----	212
Molluscan Tissue Culture - Gastropod Tissue Culture-----	214
PHYLUM BRACHIOPODA	
<u>Lingula</u> -----	215
PHYLUM ECHINODERMATA	
CLASS ASTEROIDEA	
<u>Asterias forbesi</u> or <u>A. vulgaris</u> -----	216
CLASS ECHINOIDEA	
<u>Arbacia punctulata</u> -----	220
CLASS OPHIUROIDEA	
<u>Ophioderma brevispina</u> -----	222
CLASS HOLOTHUROIDEA	
<u>Thyone briareus</u> -----	223

	<u>Page</u>
PHYLUM ARTHROPODA	
CLASS CRUSTACEA	
<u>Artemia salina</u> -----	224
SUBCLASS BRANCHIOPODA	
<u>Daphnia pulex</u> -----	227
CLASS CRUSTACEA	
<u>Cambarus</u> -----	229
CLASS INSECTA	
General Testing-----	233
General Evaluation Procedures-----	234
<u>Blattella germanica</u> (Linnaeus)-----	236
<u>Myzus persicae</u> (Sulzer)-----	239
<u>Galleria mellonella</u> (Linnaeus)-----	241
<u>Hemerocampa pseudotsugata</u> McDunnough -----	244
<u>Tenebrio molitor</u> -----	247
<u>Anthonomus grandis</u> Boheman-----	249
<u>Apis mellifera</u> Linnaeus-----	251
<u>Anopheles quadrimaculatus</u> Say-----	253
<u>Drosophila melanogaster</u> -----	255
<u>Phormia regina</u> (Meigen)-----	262
Tissue Culture Procedures-----	264
PHYLUM CHORDATA - THE PROTOCHORDATES	
CLASS ASCIDIACEA	
<u>Ciona intestinalis</u> -----	266
SUBPHYLUM CEPHALOCHORDATA	
<u>Branchiostoma</u> -----	268

	<u>Page</u>
THE VERTEBRATA	
CLASS CYCLOSTOMATA	
<u>Ichthyomyzon</u> -----	270
PISCES	
CLASS CHONDRICHTHYES	
<u>Mustellus canis</u> -----	271
CLASS OSTEICHTHYES	
<u>Amia calva</u> -----	273
<u>Lebistes reticulatus</u> -----	274
<u>Pimephales promelas</u> -----	275
<u>Salvelinus fontinalis</u> -----	275
<u>Oncorhynchus</u> -----	275
<u>Protopterus aethiopicus</u> -----	283
CLASS AMPHIBIA	
<u>Ambystoma tigrinum</u> -----	285
<u>Xenopus laevis</u> -----	287
<u>Rana pipiens</u> -----	289
Cell Lines-----	292
CLASS REPTILIA	
<u>Caiman latirostris</u> -----	293
<u>Alligator mississippiensis</u> -----	293
<u>Pseudemys scripta elegans</u> -----	297
<u>Anolis carolinensis</u> -----	299
<u>Heterodon platyrhinos</u> -----	301
Cell Lines-----	303
CLASS AVES	
<u>Gallus gallus</u> -----	304
<u>Gallus gallus</u> - juvenile-----	307
<u>Coturnix coturnix</u> -----	308

	<u>Page</u>
CLASS MAMMALIA	
<u>Mus musculus</u> -----	311
<u>Cavia porcellus</u> -----	311
EFFECT OF LUNAR SAMPLE ON WHOLE PLANTS-----	317
Plant Challenge Flow Sheet-----	318
Germination Flow Sheet-----	319
Plant Growth and Development Flow Sheet-----	320
Reproduction Flow Sheet-----	321
Plant Metabolism Flow Sheet-----	322
Effects of Lunar Sample on Cell Culture Flow Sheet-----	323
Priority Schema-----	324
Alternate List-----	325
General Statement-----	326
General Isolation Procedure-----	327
Isolation Procedure for Viral Organisms-----	328
DIVISION PROTOPHYTA	
CLASS SCHIZOMYCETES	
<u>Bacillus subtilis</u> -----	329
<u>Bacillus megatherium</u> -----	329
<u>Escherichia coli</u> -----	331
<u>Chlorobium thiosulfatophilum</u> -----	338
<u>Rhodospirillum rubrum</u> -----	339
<u>Azotobacter vinlandii</u> -----	340
DIVISION CYANOPHYTA	
CLASS CYANOPHYCEAE	
<u>Anacystis nidulans</u> -----	341

	<u>Page</u>
DIVISION CHLOROPHYTA	
CLASS CHLOROPHYCEAE	
<u>Chlorella</u> -----	342
DIVISION EUGLENOPHYTA	
CLASS EUGLENOPHYCEAE	
<u>Euglena gracilis</u> -----	348
DIVISION CHRYSOPHYTA	
CLASS CHRYSOPHYCEAE	
<u>Ochromonas danica</u> -----	350
DIVISION MYXOPHYTA	
CLASS MYXOMYCETES	
<u>Physarum polycephalum</u> -----	352
DIVISION MYCOPHYTA	
CLASS PHYCOMYCETES	
<u>Rhizopus nigricans</u> -----	354
<u>Pythium debaryanum</u> -----	356
CLASS ASCOMYCETES	
<u>Neurospora crassa</u> -----	358
<u>Saccharomyces cerevisiae</u> -----	360
CLASS BASIDIOMYCETES	
<u>Ustilago maydis</u> -----	361
DIVISION BRYOPHYTA	
CLASS HEPATICAE	
<u>Marchantia polymorpha</u> -----	362
DIVISION TRACHEOPHYTA	
CLASS FILICINEAE	
<u>Pteridium aquilinum</u> -----	364



	<u>Page</u>
CLASS GYMNOSPERMAE	
<u>Pinus palustris</u> -----	367
CLASS ANGIOSPERMAE	
<u>Allium cepa</u> -----	369
<u>Zea mays</u> -----	372
<u>Triticum vulgare</u> -----	374
<u>Oryza sativa</u> -----	375
<u>Avena sativa</u> -----	376
<u>Spinacea oleracea</u> -----	379
<u>Phaseolus vulgaris</u> -----	380
<u>Vicia faba</u> -----	390
<u>Pisum sativum</u> -----	393
<u>Daucus carota</u> -----	395
<u>Lycopersicon esculentum</u> -----	398
<u>Nicotiana tabacum</u> -----	401
<u>Antirrhinum majus</u> -----	405
<u>Lactuca sativa</u> , var. Grand Rapids-----	406
<u>Xanthium pennsylvanicum</u> -----	408
References-----	409
CHALLENGE OF BACTERIAL, ANIMAL, AND PLANT VIRUSES-----	411

#### APPENDIX

"LUNAR RECEIVING LABORATORY," <u>Science</u> , 3 Feb. 1967. <u>155</u> (3762)-----	420
COMPUTATION ON PROBABILITIES OF DETECTING MICROORGANISMS IN MASS OF LUNAR SAMPLE-----	436
Model 1-Poisson Distribution of Organisms-----	437
Nonparametric Model-----	438

	<u>Page</u>
Figure 1 - Poisson Model-----	441
Figure 2 - Nonparametric Model, $\alpha=1$ -----	442
Figure 3 - Nonparametric Model, $\alpha=10$ -----	443
STANDARD METHODS FOR THE EXAMINATION OF WATER AND WASTE WATER-----	444
Samples-----	444
Standard Plate Count-----	444
Multiple-Tube Fermentation Technique-----	447
Standard Tests-----	450
Application of Tests to Routine Examinations-----	461
Estimation of Coliform Group Density-----	462
Test for Presence of Enteric Viruses in Water and Waste Water-----	465
Other Information-----	467
MICROBIOLOGICAL REQUIREMENTS FOR SPACE FOOD PROTOTYPES-----	468
Microbiological Specifications-----	468
Methodology-----	468
References-----	473
TECHNIQUE FOR THE FLUORESCENT TREPONEMAL ANTIBODY-ABSORPTION (FTA-ABS) TEST-----	474
Reagents-----	474
Preliminary Testing-----	476
Controls-----	479
Testing-----	480
References-----	485
MEDIA FOR CULTURING BACTERIA-----	486
CREW AND ENVIRONMENT-----	486
Primary Culturing Media-----	486
Secondary Culturing Media-----	488

	<u>Page</u>
Carbohydrate Fermentation Tests-----	490
Additional Tests-----	492
LUNAR SAMPLE CULTURING-----	493
Biphasic Culturing-----	493
Protocol for Media Containing C <sup>-14</sup> -Labeled Substrates-----	494
Volcani's Media-----	497
Special Requirements for Relative Humidity-----	499
CULTURING BACTERIA FOR LUNAR CHALLENGE-----	500
Potato Extract Medium-----	500
Minimal Medium for <u>Bacillus Subtilis</u> -----	501
"C" Medium-----	501
Medium for Growing Bacteria-----	502
MEDIA FOR CULTURING TREPONEMES-----	503
MEDIA FOR CULTURING MYCOPLASMA-----	504
STAINING PROCEDURES-----	505
Gram Stain-----	505
Acid Fast Stain-----	506
Spore Stain-----	506
MEDIA FOR CULTURING ALGAE-----	507
MEDIA FOR CULTURING FUNGI-----	509
<u>Neurospora</u> Media-----	513
Liquid Media (for <u>Neurospora</u> )-----	514
Minimal Agar ( <u>Neurospora</u> )-----	514
STAINING PROCEDURES FOR FUNGI-----	515
Kinyoun Acid Fast Stain-----	515
Lacto-Phenol Cotton Blue Stain-----	515
Slide Culture Technique-----	516

	<u>Page</u>
DATA ON HIGHER PLANT MATERIALS-----	517
GENERAL PROCEDURES FOR SURFACE-STERILIZED SEEDS AND GNOTOBIOTIC PLANTS-----	518
MEDIA AND SOLUTIONS-----	519
Oatmeal Agar Medium for <u>Physarum</u> -----	519
Pollen Germination-----	519
Translocation Solution-----	519
Hoagland's Solution-----	520
Standard Media for Higher Plants-----	521
COMPOSITION OF TISSUE CULTURE MEDIA-----	522
Knudson's Solution-----	522
Knop's Solution-----	522
White's Salt Solution-----	523
Murashige and Skoog Medium-----	524
SECTIONING AND STAINING PROCEDURES FOR PLANTS-----	525
GENERAL PROCEDURE FOR USING GEL ELECTROPHORESIS AND ENZYME ASSAYS-----	529
GEL SYSTEMS FOR PROTEINS-----	530
ENZYME ASSAYS FOR GEL ELECTROPHORESIS-----	533
Peroxidase-----	533
Acid Phosphatase-----	533
Malic Dehydrogenase-----	533
Malic Dehydrogenase (Alternate Procedure)-----	534
References-----	534
VIROLOGY APPENDIX-----	535
Gradient Density Centrifugation-----	535
Concentration of Viruses on Aluminum and Calcium Salts-----	536
Preparation of Electron Microscope Grids for Particle Counting-----	538

	<u>Page</u>
Particle Counting-----	539
Virus Isolation Techniques-----	540
Hemadsorption-----	542
Hemagglutination Tests-----	543
Tissue Culture Media-----	544
Composition of Three Tissue Culture Media Containing Biologic Substances-----	546
Classification of Animal Viruses into Groups Based on Chemical and Physical Properties-----	547

CONTAINMENT

## CONTAINMENT

### 1. PERSONNEL AND EQUIPMENT

The uncertainty of the existence and type of pathogenic life on the lunar surface is of concern. Until the potential biological hazard is assessed, the following procedures shall be recommended.

- A. Astronauts returning from lunar or planetary missions shall be placed in quarantine upon return to earth and their microbiological profiles obtained. Suits and protective devices shall be provided for both the astronauts and personnel who may be exposed to either the men or the command module.
- B. Immediately upon return, the spacecraft, the lunar sample containers, the astronauts, and all persons who have come in contact with them shall be placed into an isolation environment. This isolation shall be maintained for the duration of the quarantine.
- C. An air-tight, water-tight trailer shall be used as a mobile quarantine facility in returning the crew, associated personnel and other items to the Manned Space Center.
- D. Spacecraft, suits, and equipment shall not be decontaminated until biological studies have been made on them and shall be kept in isolation until released.
- E. The Manned Spacecraft Center shall provide the necessary facilities and equipment for biological isolation. This quarantine shall begin immediately at retrieval and will include the lunar samples, flight tapes and film, specified equipment, food, water, urine, fecal

samples, flight crew, and personnel required to have immediate contact with the flight crew.

## II. LUNAR SAMPLE CONTAINMENT PROCEDURES

Lunar samples shall be opened as promptly as possible upon return to earth and be examined behind absolute biological barriers using rigid bacterial and chemical isolation techniques.

A primary-secondary barrier concept or double barrier concept shall be employed.

### A. Primary-secondary barrier concept

#### 1. Primary barriers

Primary barriers shall be established as the first line of defense for containing the lunar sample. The primary barrier shall be gas-tight cabinets or isolators.

#### 2. Secondary barriers

The secondary barriers are the features of the facility that surround the primary barriers. They shall provide the buffer zone around the primary containment arrangements and include:

- a. Floors
- b. Walls
- c. Ceilings
- d. Air locks
- e. Change rooms
- f. Air filtration or incineration units for the building.
- g. Zones of differential air pressure



- h. Provisions for treatment of liquid and solid wastes
- i. Traffic patterns of personnel and materials

### 3. Zonal barriers

Another way of viewing facility design for microbiological contamination control is to define the zones that relate to containment functions. Only one of four identified functional zones of this total facility has a containment function. The other three zones support the containment zone (or the mission area) in several ways:

- a. Provide office areas and transitional rooms
- b. Provide a mission support zone
- c. Provide a zone for the machinery that operates the building.

### B. Equipment

Engineering developments have provided devices that offer efficient microbiological and physical separation between environments. As discussed above, the most important type of containment and isolation equipment and the type capable of meeting the most severe control criteria is the gas-tight, absolute barrier enclosure. Ventilated work cabinets and animal cages are representative of this type of equipment. When the contamination control criteria are severe, as when sterility is to be preserved, no substitute for the absolute system is known. In terms of initial cost and operational time, absolute containment systems are almost always more expensive. On the other hand, sometimes the fiscal

or other consequences of failure to provide adequate contamination control are so severe as to warrant absolute containment at any cost. References describing the design source and use of ventilated cabinets and animal isolation equipment are found at the end of this section.

The following characteristics shall be employed:

1. These absolute barriers shall allow no interchange of the protected and non-protected environment and shall aim at total containment.
2. They shall provide for placement of the material or the work to be controlled within a gas-tight enclosure.
3. Humans shall be separated from the system.
4. The work shall be done through attached arm-length rubber gloves or by means of remote mechanical manipulators.
5. When work within the barrier is to be protected from outside contamination, the enclosure shall be maintained at a positive air pressure.
6. Conversely, negative pressure shall be used to prevent escape of contaminants.
7. Inlet and/or outlet air may be filtered or heated to destroy microorganisms.
8. Prior to use, the enclosure shall be decontaminated or sterilized. An efficient means of sterilizing or decontaminating all interior surfaces of the barrier shall be provided. The use of ultraviolet in air locks as the only sterilizing agent

is questionable.

9. Internal surfaces shall be resistant to chemical corrosion and free of cracks or crevices that would interfere with sterilization and decontamination.
10. Adequate visual viewing panels between the operator and the operation shall be provided.
11. Appropriate air locks, dunk baths, autoclaves, gas chambers, and other devices shall be attached to gas-tight barriers so as to allow passage of essential supplies and materials.
12. There shall be ample amount and arrangement of working space within the barrier to minimize the need to transfer material in and out of the barrier before completion of an operation.
13. Appropriate services such as electricity, gas, vacuum, air, light, ultraviolet irradiation, water, and drains shall be provided.

C. Techniques

Even in the presence of adequate facilities and good containment equipment, the success of attempts to control microbiological contamination depends in part on the work techniques of the involved personnel. Although no inclusive list of correct techniques would be appropriate for all areas of application of microbiological contamination control, some fundamentals that suggest correct techniques and some general types of procedural rules that shall be followed are listed below.

## 1. Fundamental ideas

- a. Microbial contamination can exist and yet be not readily detectable in the usual sense.
- b. The contamination may be odorless, tasteless, and invisible.
- c. Instantaneous monitoring devices for microorganisms, comparable with devices for detecting radioactive contaminants, are not available.
- d. It is important to understand the ease with which microorganisms can be made airborne and their ability to remain airborne in small particulate form and to move from place to place in air currents.
- e. It is significant that the physical state of a microbiological contaminant is related to the ease or difficulty of containment. Thus dried, micronized, powdered, or lyophilized microbial preparations are much more difficult to contain than contaminants in a wet or fluid state.

## 2. Correct techniques

In general, "correct techniques" shall relate to the movements of people insofar as these movements can minimize the spread of contamination through the air or on surfaces. Traffic patterns of personnel and materials shall be kept to a minimum. The following techniques shall be avoided to achieve minimum spread of contamination.

- a. Violent movements
- b. Aspiration of fluids

- c. Spraying of materials
- d. Foaming or bubbling of liquids
- e. Overflow or leakage of materials.

D. Decontamination and sterilization

Sterilization and decontamination agents have three general uses in microbiological barrier systems. Table 1 shows recommended agents of each barrier application. It is obvious that not all the sterilizing and decontaminating agents shown in Table 1 will act with equal efficiency and reliability and that the table does not cover all possible agents.

1. The barrier system and all of its components shall be sterilized or decontaminated before use.
2. Supplies and equipment that must be moved in or out of the barrier while it is in use shall be sterilized if possible.
3. Decontaminating procedures shall be used within the barrier while it is in operation to maintain its sterility or microbiological state.

Table 2 summarizes the recommended treatments and limitations of use for some of the sterilization and decontamination agents commonly used with microbiological barriers.

E. Contamination control criteria

Attempts to control contamination lack significance unless the standards of control are defined.

These criteria shall be established in a manner to facilitate validation of control processes. Since sterility shall be the

objective, the criteria shall specify the procedures to be used in testing for sterility, how many replicate tests are needed, when the tests are to be done, etc. These surveillance techniques shall include:

1. Air sampling
2. Surface sampling
3. Component, item, or material sampling
4. Physical and chemical tests
5. Testing of filters, incinerators, sewage and water
6. Gastightness testing

#### F. References

Blickman Catalog on Safety and Vacuum Enclosures, 1967. S. Blickman, Inc., Weehawken, N.J.

Gremillion, G. G. 1959. The use of bacteria-tight cabinets in the infectious disease laboratory, p. 171-182. In Proc. 2nd Symp. Gnotobiotic Technol., Univ. Notre Dame Press, Notre Dame, Indiana.

Gustafsson, B. E. 1959. Lightweight stainless steel systems for rearing germfree animals. Ann. N. Y. Acad. Sci. 78: 17-28.

Shepard, C. C., May, C. W., Topping, N. H. 1945. A protective cabinet for infectious disease laboratories. J. Lab. Clin. Med. 30: 712-716.

Trexler, P. C. 1960. Flexible-wall plastic film isolators, p. 55-60. In Proc. 2nd Symp. Gnotobiotic Technol. Univ. Notre Dame Press, Notre Dame, Indiana.

Van den Ende, M. 1943. Apparatus for the safe inoculation of animals with dangerous pathogens. J. Hyg. 43: 189-194.

TABLE I  
 STERILIZATION AND DECONTAMINATION AGENTS  
 FOR MICROBIOLOGICAL BARRIERS

Use of Sterilization or Decontamination Agents	Recommended Sterilizing or Decontaminating Agents
1. Before or after barrier is put into operation.	1. Steam under pressure 2. Ethylene oxide gas 3. Peracetic acid 4. Steam formaldehyde 5. Beta-propiolactone 6. Liquid germicide rinses
2. Treatment of supplies and equipment moved in or out.	1. Steam under pressure 2. Dry heat 3. Ethylene oxide gas 4. Dunk bath solutions 5. Peracetic acid pass-through 6. Ultraviolet air lock
3. Maintenance of conditions inside barriers during operations.	1. Atmosphere of germicidal gas 2. Irradiation with ultraviolet 3. Periodic wash-down with liquid decontaminants. 4. Periodic resterilization

G.B. Phillips, "1966 Biological Contamination Control"

TABLE 2  
SOME RECOMMENDED AGENTS AND TREATMENTS FOR  
STERILIZATION OR DECONTAMINATION  
IN MICROBIOLOGICAL BARRIERS

Sterilization or Decontamination Agent	Recommended Treatments*	Limitations of Use
Moist Heat (autoclave, high vacuum)	135°C, 3-5 min	Not including come-up time. Effective if material is pervious to steam; otherwise effect is essentially that of dry heat.
Moist Heat (autoclave, no vacuum)	121°C, 15-30 min	Not including come-up time or size of vessels.
Dry Heat	160°C, 2 hrs; 170°C, 1 hr.	Not including come-up time. Other combinations of temperature and time are acceptable.
Ethylene Oxide Gas (in a non-explosive gas mixture)	25°C, 300 mg/l, 8-16 hrs, 30% RH	Will not penetrate solids. Absorbed in rubber and plastics necessitating aeration if material is to contact skin.
Peracetic Acid Spray	25°C, 2% with 0.1% surfactant, continuous for 20 min.	Corrodes many metals. Degrades to active acid, oxygen, and water.
Steam-Formaldehyde Vapor	25°C, 1 ml/ft <sup>3</sup> in air, RH above 80%, 30 min (cabinets) or 10 hrs (rooms)	Formaldehyde polymerizes on surfaces, often necessitating long aeration periods prior to reentry.
Beta-Propiolactone Vapor	25°C, 200 mg/ft <sup>3</sup> in air with RH above 70%, 30 min (cabinets) or 2 hrs (rooms).	Aeration required prior to entrance into area.
Dunk-Bath Formalin (37% HCHO)	25°C, 10%, 10 min.	Irritating fumes.
Sodium Hypochlorite Solutions	25°C, 500-5000 ppm with 1% surfactant, 5 min.	Corrodes many metals.
Strong Tincture of Iodine (7%)	25°C, 10 min.	Stains many materials.
Ultraviolet Radiation (2537A)	25°C, 800 micro-watt min per sq cm.	Low penetrating power. Use limited to clean exposed surfaces and air. Bulbs must be checked and kept clean. Causes eye burns.

\* Recommendations are based on maximum effectiveness against bacterial spores and are made on the basis of direct or conservatively extrapolated experimental data.

G.B. Phillips, "1966 Biological Contamination Control"



PRELIMINARY SEARCH FOR ORGANIC COMPOUNDS BY MEANS OF  
MASS SPECTROMETRY

PRELIMINARY SEARCH FOR ORGANIC COMPOUNDS

BY MEANS OF MASS SPECTROMETRY

For various reasons, it seems to be imperative to test the specimens of lunar surface and subsurface returned to earth as soon as possible for the presence of organic compounds. These experiments will have to be performed while the samples remain in quarantine; i.e. before they are released from the Lunar Receiving Laboratory to those laboratories in which the much more sophisticated and detailed investigations concerning the nature of possibly present organic substances are carried out.

In these investigations, mass spectrometry will play an important role and for the same reasons (high sensitivity, very general applicability, high information content of the data) this technique is the most promising candidate to provide a rapid and permanent record of data on small amounts of material without chemical treatment of the sample. In fact, remote operation of the system, most of it from outside the "biological barrier," is proposed.

Three objectives are to be achieved in these experiments:

1. To detect any volatile organic compounds that may emanate from the lunar material after the removal from its environment and during transit to earth. Such "outgassing" may be caused by various effects, such as:
  - a. Warming of a subsurface sample to ambient LEM temperature accompanied by vaporization of volatile materials or physical changes in the inorganic matrix resulting in release of occluded volatile matter.

- b. Radiolysis of large molecules in a radioactive piece of lunar "rock."
  - c. Other, presently unexpected physical or chemical events taking place in the sample during collection or return.
2. To provide at least a partial record of the organic constituents present in the lunar material at the earliest possible time; i.e., before any appreciable terrestrial contamination has taken place. This record may prove invaluable if, in spite of the rigorous precautions that will be taken by the investigating laboratories in the later work, any doubt should arise concerning the origin of a particular constituent identified later.
3. To obtain preliminary information about the concentration and complexity of organic materials in the lunar material. This information would provide a guide for the most effective distribution of the samples to the investigating laboratories. Obviously, a different lunar sample distribution pattern (size and number of samples) would be followed if the samples should turn out to be very rich in organics, to contain only small hydrocarbons, or to be free of any detectable organic materials. It would be equally important to know as early as possible whether the majority of the organic material consists of polymeric material (like "kerogen") or relatively small ("monomeric") molecules and, if so, what compound types predominate. Such information would be very valuable in helping to plan the detailed investigations to follow in the experimenters' own laboratories after the quarantine has been lifted.

Such information would be particularly important if we were fortunate enough to obtain reasonably large samples from quite different locations on the surface as well as the subsurface. In such a case, it would be important to perform such a preliminary investigation to assure that the samples of highest organic content are allotted to the laboratories of the Bioscience area.

#### I. METHOD OF INVESTIGATION

A simple, speedy, sensitive, and generally applicable technique, yielding a specific, permanent record, interpretable immediately as well as later, is required. There is no doubt that single focussing mass spectrometry is the best choice.

The data provided by this technique would enable one to identify single components or simple mixtures of organic compounds from their characteristic mass spectra, which contain information concerning the size of the molecules from the mass of their molecular ions, their structure from the fragments produced on electron impact and their approximate concentration from the intensity of the spectrum. Of more complex compounds and/or mixtures probably only more general conclusions (such as general molecular size, structural complexity and level of concentration) could be drawn at that point. As was pointed out, it is this type of preliminary information which would be particularly valuable at that early stage. In order to fulfill these requirements and not to interfere with the main purpose and special requirements of the LRL, the investigation should be devoid of any complicating frills, such as chemical pretreatment of the sample

(i.e., extraction), pre-separation (i.e., gas chromatography), or operational problems (caused, e.g., by use of double focussing instruments of high resolving power but comparatively lower sensitivity).

It is proposed to provide a vacuum lock large enough to accommodate one of the "lunar-vacuum" sample containers and pierce its wall after the system has completely pumped down and reached acceptable background levels. Rapid, repetitive scanning of the spectrum, as well as monitoring of instrument parameters; e.g., temperatures of inlets, fields, etc., assures recording of everything that emerges from the moment of piercing to the end of the experiment.

For the recording of the mass spectra of substances held within the sample, 0.05 to 1.0 gram specimens will be placed through a vacuum lock in a small furnace within the ion source housing and heated, at a controlled and monitored rate, to ca. 500<sup>o</sup>, while continuously recording the spectrum of the gas phase over the sample.

A specially designed single focussing magnetic deflection mass spectrometer of high sensitivity will be used. The spectra will be continuously monitored on an oscilloscope and, at the same time, permanently recorded employing on-line computer acquisition, processing, and display of the data. Provision for producing a master tape containing the original data, which can be duplicated, would allow their permanent retention and prevent accidental loss. Various forms of such data acquisition systems are presently under development in the investigators' laboratories and could be modified to suit this purpose with relative ease.

Such a combination system will provide ease of manipulation in obtaining the raw data, real-time processing, and display of "normalized" plotted spectra during the experiment and increase accuracy of the original raw data.

In this fashion, the mass spectra of all organic substances that can be expelled in significant amounts from the lunar materials by the action of heat at low pressures can be recorded. Similarly, most substances not volatile under these conditions will undergo pyrolysis and give rise to the appearance of the characteristic compounds at the higher sample temperatures. While a detailed interpretation of the spectra obtained in terms of specific compounds will be quite difficult, the data will indicate the degree of abundance, as well as the type (in very general terms) of the compounds possibly present. Most important, any compound found later to be present would have given rise to certain characteristic peaks. Their possible absence in these original spectra would cast doubt on the genuineness of this component and require a search for possible terrestrial sources for this substance as a contaminant.

## II. SAMPLE TRANSFER INTO THE MASS SPECTROMETER

As outlined above, there are two principally different sampling systems required:

- A. For the recording of the mass spectrum of the gas phase in a selected, vacuum-tight container, a vacuum lock large enough to accommodate the container itself is required. A bellow connection between a hollow needle and the ionization chamber should make it

possible to establish connection of the ionization region with the inside of the sample container by piercing its wall after the instrument background has reached a suitably low level.

- B. For the recording of the mass spectra of the compounds evolving upon heating a sample, a modification of vacuum-lock type sampling systems presently in use is considered. Modifications would involve increase in size to accommodate larger samples and facilities for remote operation and feedback control.

Since there is a finite possibility that the number of samples that will be returned to earth in tightly sealed containers will be small, one should be prepared to use the organic material that will be evolved during the course of the inorganic gas (and isotope) analysis (Dr. Schaeffer, Principal Investigator, Geochemistry Group).

For this purpose the trap used to condense the organic material should be provided with valves and flanges which permit its removal from the gas analysis system and connection to the mass spectrometer described above.

### III. PERSONNEL REQUIREMENTS

Because of the high degree of experience required to perform these experiments, they must be carried out by scientists trained in this field. A detailed step-by-step description of the procedure, as it would be required if the task were performed by people other than those who developed these techniques, is thus neither possible nor required.

### IV. DISTRIBUTION AND INTERPRETATION OF RAW DATA

It is intended to interpret the data during and immediately following their acquisition. This interpretation shall be the product

of our informal discussion group (consortium), consisting of organic mass spectroscopists representing all those groups who have been, by that time, specifically approved for investigation of the lunar samples by mass spectrometry, because the experiments outlined above are performed mainly for their benefit. Duplicates of the raw data tapes are to be distributed to these groups of principal investigators.

It should be very clearly understood that these preliminary investigations to be performed at LRL and discussed above represent only a very small part of the analytical-organic chemical investigations to be performed on the various lunar samples after release from quarantine. These detailed and complex experiments will involve isolation, enrichment, and separation of the possibly very complex mixture of traces of organic material and its characterization by high resolution mass spectrometry, gas chromatography, and various other physical methods. These experiments will take a reasonable amount of time and require very complex equipment and highly specialized training and will be carried out at the few laboratories which will at that time have the required capability. The preliminary data will provide initial guidance as well as an indisputable early record of some sort.

#### V. SPACE REQUIREMENTS

As a rough estimate of the space required, one can say that floor space of 8' x 10' in a room 15' x 20' is required for the mass spectrometer. Two alternatives are possible:

- A. The entire instrument is behind the "biological barrier."
- B. Preferentially, only the sample handling part and the ion source housing of the spectrometer penetrates behind the barrier. The sample handling system would have to be operated from outside the



barrier (with mechanical manipulations).

For the data acquisition system, also, 8' x 10' floor space is desirable in a room 15' x 20', which may be occupied, in part, by other equipment. The data acquisition system should be outside the biological barrier but very close (within a few feet of cable) to the spectrometer.

MICROBIOLOGICAL PROFILES

### CREW AND ENVIRONMENT MICROBIOLOGY

Special examination of the astronauts and isolation of the samples and other materials that have been in contact with lunar material are necessary until there is reasonable assurance of the absence of back contamination that would endanger the public's health, agriculture, and other living resources. The astronauts, having been on the Moon's surface, will be considered to have been exposed to lunar material and therefore potentially exposed to any harmful lunar biological materials. For this reason, they will be quarantined in the LRL after recovery for a minimum of 30 days. However, at least 60 days would be preferable. The recovery operation and transport of astronauts back to the LRL will be done with appropriate means of biological isolation.

All material taken from terrestrial environment into flight must be sterilized if possible and tested for microbial profile. The pre-flight profile should include tests for the presence of bacteria, viruses, mycoplasmas, fungi, and parasitic protozoans. It is necessary to establish a pre-flight profile of indigenous microorganisms of the crew, their contacts, suits, spacecraft, and food, for use as baseline information for post-flight comparative purposes. Post-flight microbiological analysis of the crew, their contacts, suits, and spacecraft will indicate any possible alterations resulting from Apollo flight and lunar landing, particularly with respect to pathogens.

PROTOCOLS FOR THE RECOVERY  
OF MICROORGANISMS FROM THE CREW

PRE-FLIGHT TESTING PROCEDURES

The men shall be brought together at least two weeks\* prior to flight to obtain a complete profile of microorganisms. All personnel in close contact with the men during this isolation period, such as physicians, technicians, etc., shall be included in these tests. Any illness in the astronauts' families shall also be monitored. Conventional terrestrial media shall be used. After the first flight, lunar media or simulated lunar media shall be included. Men shall be tested for potential pathogens. If any pathogens are found, they shall be eradicated before the flight.

Astronauts shall be isolated at least 10 days prior to the flight at a predetermined site which will allow contact only with each other and necessary medical personnel.

The astronauts shall have a complete microbiological profile performed prior to flight to establish baseline information for post-flight comparison and to establish the degree of commonality and compatibility of microflora among crew members. Initial relative proportions of given organisms shall also be observed.

BACTERIA

I. METHOD OF COLLECTION

The samples shall be taken during the testing period before flight at designated intervals so that a minimum of six samples shall be taken

---

\* 21 days or longer has been suggested by several consultants.

from each of the body areas designated A and a minimum of three from the B areas on each subject. If possible, several samples should be obtained prior to close contact among the men. The men should thereafter be together but isolated from other men except for those surgically gowned. Daily samples during the pre-flight incubation period are suggested. Collection methods shall be coordinated as much as possible with mycoplasma, viral and the other protocols dealing with crew microbiology (See Table II).

The method of collection for each area is as follows:

A. Body Areas - Two swabs from each body area shall be collected.

The body areas are listed in order of importance. One swab is to be placed immediately in 10 ml thioglycollate broth or Gall's broth plus cysteine for anaerobic culturing and one is to be placed in 10 ml trypticase soy or heart infusion broth for aerobic culturing.\*

Collection shall be made by swabbing a 1 by 1/2 inch area as follows:

1. Throat - While depressing tongue, swab tonsillar area. (A area)
2. Groin - Swab from front toward rear. (A area)
3. Toe webs - Swab area between toes. (A area)
4. Glans penis - Swab specified area of skin of glans, or between glans and foreskin. (A area)
5. Scalp - Swab with a scraping motion within the area of hair growth. (B area)
6. Gingival area - Dental instruments shall be employed to obtain samples from the appropriate area. (B area) The collection of salivary samples has also been suggested.

---

\*Where specimens are collected for virology and mycoplasma from the same area, the specimen shall initially be placed in veal infusion broth. Half of this shall be removed, antibiotics added, and used for viral isolation procedures. The other half shall be treated as indicated above.

7. Ear - While pushing earlobe down and toward neck, gently swab external auditory canal with circular motion. (B area).
8. Axilla - Swab with care to get specimen from skin below hair area. (A area).
9. Umbilicus - Gently expose deeper folds of umbilicus by pulling upwards on surrounding abdominal tissue in order to swab all areas. (B area).
10. Nose - Nasal wash, see virology protocol for complete procedure.
11. Eye - Evert lower eyelid and swab conjunctiva gently, following contour of eyelid with swab. (B area).
12. Anal fold - The swab shall be gently rolled over the area immediately adjacent to external anal sphincter. (B area).

For purposes of approximate quantitation, each swab is considered to contain about 0.01 gm of sample.

B. Feces

Fecal samples shall be eliminated into sterile plastic containers and shall be cultured within 15 minutes of elimination (A area) if possible. This is the most important sampling area.

C. Urine

An intermittent-voiding-midstream sampling shall be used. The first running shall be discarded and the second collected in a sterile vessel. (B area).

D. Blood

Ten ml of blood shall be collected aseptically on three different days. (A area).

## II. PRIMARY CULTURING

The samples shall be examined immediately for both aerobic and anaerobic bacteria as well as yeasts, molds, and actinomycetes by the methods outlined below, using the media specified for each area in Table I.\*

### A. Body areas

#### 1. Aerobic

The aerobic swab collected for each body area shall be emulsified in 10 ml of broth into which it shall be placed when collected. The media in Table I shall be inoculated from this tube. Ten-fold serial dilutions in 4-6 tubes shall be made in trypticase soy depending upon the number of organisms expected to be present in the sample, based on previous experience. The exact procedure for culturing is shown in Figure 1. The trypticase soy broth series shall be incubated aerobically at 35°C and observed for growth at 24 and 48 hours. All cultures showing growth shall be smeared. Aerobic plates shall be made on the media listed in Table I for each of the body areas by spreading 0.1 ml of broth from the lead tube + 1 on the plate using a glass spreader or from an appropriately dilute tube to allow adequate separation of colonies on the plates. Changes in the tube from which platings are made may be necessary after a period

---

\* The use of insonation is recommended as an alternate procedure in recovering microorganisms from swabs and specimens.

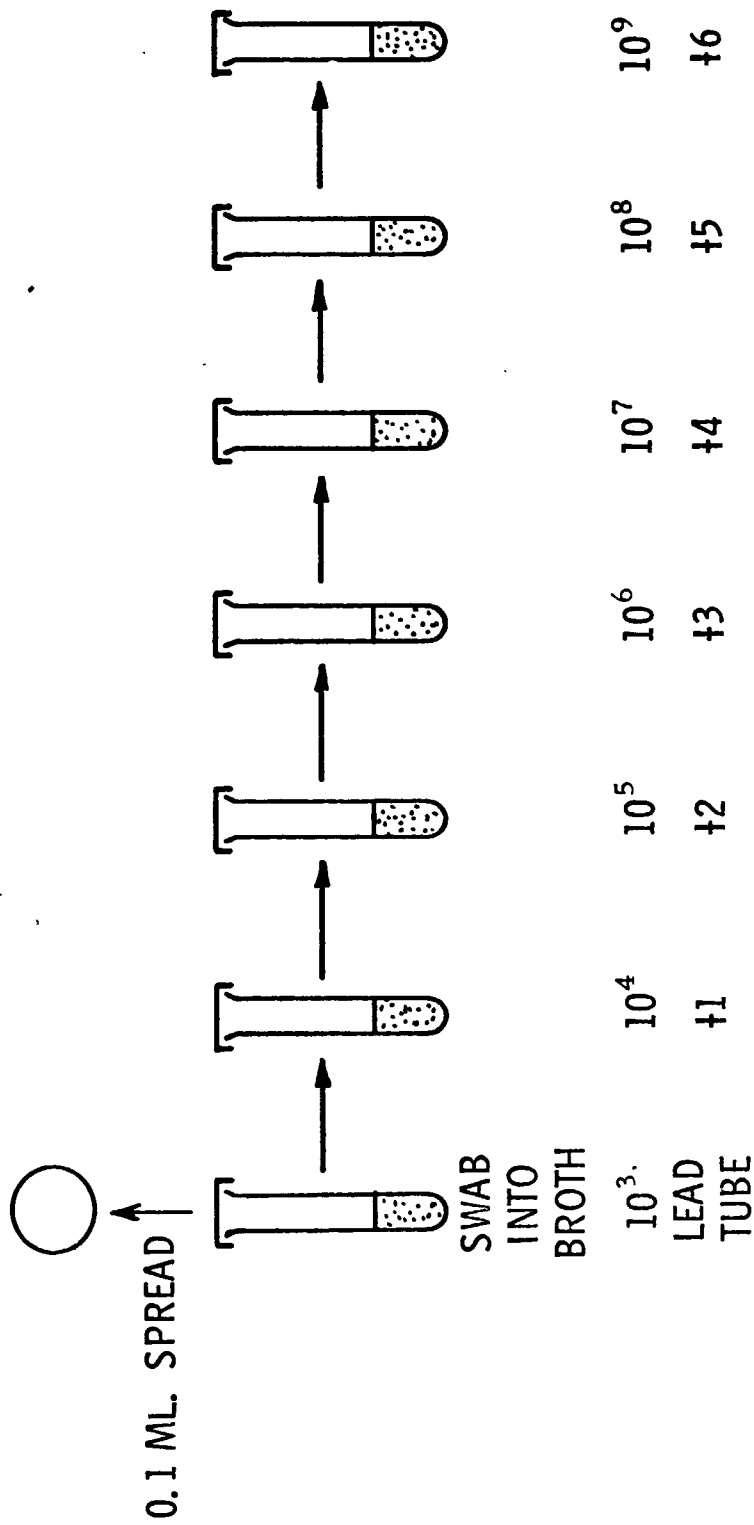

Platings are dependent upon prior counts and change during the run. The counts resulting from these varied dilutions are changed and recorded as would appear on  $10^4$ .

FIGURE 1. AEROBIC OR ANAEROBIC CULTURAL SERIES FOR ALL BODY AREAS



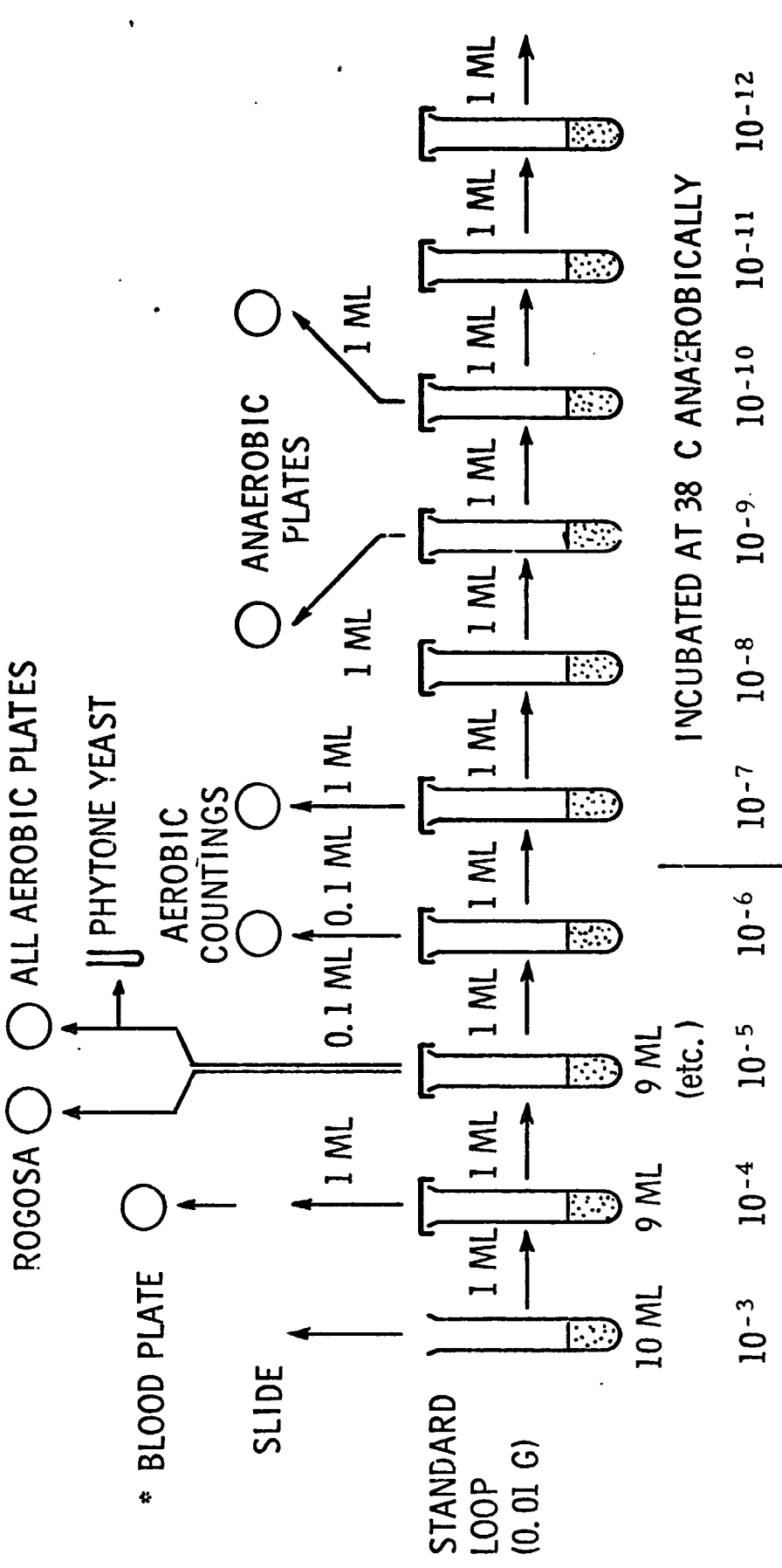

\* For additional identifications

FIGURE 2. ANAEROBIC DILUTION SERIES (FECES)

DIA	SCALP	EAR	EYE	NOSE	GINGIVAL	THROAT	AXILLA	UMBILICUS	GROIN	GLANS PENIS	ANAL FOLD	FECES	TOES	URINE
tract Agar Agar	X	X	X	X	X	X	X	X	X	X	X	X	X	X
	X	X		X	X	X	X	X	X	X	X	X	X	X
	X	X		X	X	X	X	X	X	X	X	X	X	X
80 101 Medium <sup>1</sup> Simulated <sup>2</sup> Medium	X	X	X	X	X	X	X	X	X	X	X	X	X	X
	X	X		X	X	X	X	X	X	X	X	X	X	X
	X	X		X	X	X	X	X	X	X	X	X	X	X
80	X	X		X	X	X	X	X	X	X	X	X	X	X
	X	X		X	X	X	X	X	X	X	X	X	X	X
	X	X		X	X	X	X	X	X	X	X	X	X	X

ject's blood added to trypticase soy or agar at 5% level.

ified Sabouraud's or mycobiotic agar can be used as substitutes.

irst time, pre-flight thereafter (to determine any morphological changes on terrestrial organisms).

TABLE I.

COLLECTION OF SPECIMENS FOR CREW MICROBIOLOGY

	FECES (A)	BLOOD (A)	URINE (B)	THROAT (A)	GROIN (A)	TOE WEBS (A)	GLANS PENIS (A)	SCALP (B)	GINGIVAL AREA (B)	EAR (B)	AXILLA (A)	UMBILICUS (B)	NOSE (A)	EYE (B)	ANAL FOL	
PRIMARY ACTION JM																
AEROBIC	VIB VIB	VIB VIB	VIB VIB	VIB VIB	TS T	TS T	TS T	TS T	TS T	TS T	TS T	TS T	VIB VIB	VIB VIB	TS T	
VIROLOGY	X	X	X	X	X	X	X	X	X	X	X	X	X	X	X	X
SPOROZOANES		X					X		X				X			
VIROLOGY	X	X	X	X									X	X		
PLASMA			X	X			X		X				X	X		
VIROLOGY ;																
SPOROZOANES	X	X	X						X							X
HELMINTHS	X	X	X	X									X			X

= Veal infusion broth  
 = Trypticase (or tryptic) soy broth  
 = Thioglycollate broth

Sampling Periods:

Viology: 3 different days (eye, feces, blood, urine)  
 every other day (nose, throat, anal swab)

Other protocols: 6 specimens from A areas  
 3 specimens from B areas

TABLE II

of not washing, such as immediately upon return from the lunar voyage. Aerobic count shall be taken from a blood plate. Both total and differential counts of the aerobic and anaerobic bacteria in the specimen prior to enrichment shall be obtained.

## 2. Anaerobic

The anaerobic swab from each body area shall be emulsified in 10 ml of broth into which the swab is placed when collected. The sample shall then be 10-fold serially diluted through 4-6 tubes of fluid thioglycollate or Gall's broth containing cysteine by making the appropriate dilutions, which depend upon the numbers of organisms expected in that particular sample. This procedure, which is essentially the same as the aerobic method, is depicted in Figure 1. The cultures shall then be incubated in a nitrogen incubator with 10% CO<sub>2</sub> at 35°C and observed after 24 and 48 hours for growth. If time and space permit, agar shakes in Gall's agar shall be made from the top 2 or 3 dilutions showing growth, and slides are to be made on all cultures that show growth. The agar shakes shall then be further studied. If time and space permit, anaerobic Brewer plates shall also be made with 1.0 ml of the appropriate dilution of the throat, buccal and glans penis samples using Gall's agar with cysteine. A blood agar plate shall be inoculated with 0.1 ml from the lead tube + 1 and spread over the surface of the plate with a sterile, bent-glass rod. A pour plate of Rogosa's agar, when appropriate, shall be inoculated with 1.0 ml of the lead tube + 1. These plates shall be

incubated in the anaerobic incubator with 10% CO<sub>2</sub>.

B. Primary culturing of feces

1. Aerobic

The inoculum for the aerobic plates from the fecal sample shall be taken from the anaerobic broth series. One-tenth ml from the lead tube + 1 shall be spread on one blood plate. All other aerobic media listed in Table 1 under the column for feces (including the second blood plate) shall be made by spreading 0.1 ml of the lead tube + 2 on the plate with a glass rod. 0.1 ml of the lead tube + 2 shall be also used as inoculum for a pour plate for the aerobic count. One ml of the lead tube + 2 is to be used as inoculum for the Rogosa's pour plate.

2. Anaerobic

The anaerobic broth series for the primary culture of the fecal sample shall be correlated with the viral culture procedures insofar as possible. Ten grams of fecal material shall be mixed in 100 ml Hanks Balanced Salt solution containing no antibiotics. Figure 2 gives a schematic representation of the primary culturing technique, which is modified to culture from 0.01 g (0.1 ml of the above mixture) or a standard loopful of freshly eliminated fecal material. Samples shall be cultured within fifteen minutes of elimination.

The fecal inoculum shall be placed into a tube containing 10 ml of thioglycollate or Gall's broth prepared with two drops of cysteine and one drop of sodium bicarbonate. This tube is considered to represent

roughly a  $10^{-3}$  dilution of the fecal contents. Serial dilutions are to be made into 9 additional tubes containing 9 ml of thioglycollate or Gall's broth prepared as above by transferring 1 ml from the inoculated tube into the next tube, etc. The top 9 tubes shall be labeled in numerical order and incubated anaerobically in a nitrogen incubator with 10%  $\text{CO}_2$  until growth occurs (usually within 48 hours). Observations shall be made at 16 and 24 hours and daily thereafter. These tubes are to be considered to approximate a dilution of the sample from  $10^{-4}$  to  $10^{-11}$ . No dilution blanks are to be used, as each tube containing broth acts as a dilution blank for the next tube in the series. If time and space permit, pour plates shall be made into anaerobic Brewer dishes from tubes 6 and 7 using Gall's medium with cysteine and bicarbonate added.

If time and space permit, the top three tubes showing growth shall be subcultured into agar shakes using thioglycollate or Gall's medium to observe the anaerobic or aerobic character of the growth and to preserve the cultures for transport and for purification and study.

Blood plates shall also be made from the  $10^{-4}$  and  $10^{-5}$  dilution of the fecal sample by the same technique as the aerobic plates from the other body areas and shall be incubated in the same manner as the anaerobic broth series. Growth shall be recorded after 24-48 hours and the plates shall be treated in the same manner as the aerobic blood plates described in the section on secondary culturing.

#### C. Primary culturing of urine

One drop of urine shall be spread over plates of the media designated in Table 1.

D. Primary culturing of blood

Aseptically-drawn blood shall be placed into the media designated in Table 1. Hyland di-phasic bottles which are three-sided (chocolate agar layer on one side, nutrient agar on the second side, and no medium on the third side) shall also be used. These bottles shall contain trypticase soy broth and shall have an atmosphere of either 10% CO<sub>2</sub> + 90% air or 10% CO<sub>2</sub> + 90% nitrogen. They shall be incubated at 25° and 35°C.

III. SECONDARY CULTURING

A. Aerobic

All the cultures from the Petri dishes shall be incubated aerobically and in containers with air plus 10% CO<sub>2</sub>. Selected colonies shall be picked into broth. All other colonies from the aerobic plates shall be processed by the usual aerobic methods. The cultures shall be smeared, stained, observed microscopically, separated according to morphological types, and processed according to the schema on the following pages or that used in standard diagnostic bacteriological identification schema. These include secondary culturing on differential media, biochemical testing, and sero-typing.

B. Anaerobic

1. Body areas

If agar shakes and brewer plates were made, the organisms shall be separated into two groups, depending upon the degree of anaerobiosis. The obligate anaerobes shall be processed in the same way as the fecal anaerobes described below with the exception that many of the cultures, particularly from the gingival area, throat, and glans penis, shall be identified from Bergey's manual.

The facultative anaerobes shall then be grouped according to morphology and shall be processed as indicated for the aerobes of similar morphology.

## 2. Feces

Cultures from the top three tubes of the series shall be processed in the following manner. The agar shake cultures, if made, shall be transferred to thioglycollate or Gall's broth plus cysteine and incubated anaerobically until growth occurs. Gram stains shall be made from the plates. If the cultures are pure, they shall be immediately processed as described below. Cultures showing two or more distinct morphological types of bacteria shall be purified by plating, using the following anaerobic technique. A loop of the impure broth culture shall be spread on blood agar or on a bed of Gall's agar, which shall then be covered with a layer of Gall's agar with added cysteine. The plates shall be incubated anaerobically in a nitrogen incubator with 10% CO<sub>2</sub> and discrete colonies shall be picked. Selected colonies on the anaerobic Brewer dishes originating from tubes 5 and 6 shall be picked and treated like the subcultures from the agar shakes, as described above, if these experiments have been done. The physiological studies of the pure cultures isolated from the feces shall include the following screen tests:

- a. Gram stain to observe morphology.
- b. Final pH in 0.1% glucose broth.
- c. Fermentation of the following carbohydrates in Andrade's



fermentation broth base (glucose, sucrose, lactose, dextrin).

These sugars shall be added at 0.1% level aseptically after autoclaving.

- d. Growth in thioglycollate or in Gall's broth with no carbohydrate.
- e. Liquefaction of 12% gelatin, in standard media for these tests, or in Gall's media minus carbohydrate.
- f. Growth and reaction in litmus milk (to which 0.05% bovine albumin and 0.1% of peptone have been added) shall be observed.
- g. Growth in agar shake containing blood or Gall's medium shall be observed.

### 3. Urine

The procedures shall follow those listed in the schema for Pre-flight Testing and are the same as those given for the body areas.

### 4. Blood

The procedures shall follow those outlined in the schema for Pre-flight Testing.

In the section on media composition, the technique and selective reaction is described. The media are grouped according to primary or secondary media and are alphabetized in each group. Media which may be used both as primary and secondary media will be included in the primary media only.

## C. Schema for Secondary Observation of Aerobic Cultures

### 1. Staphylococci and Micrococci

Cultures shall be placed on Mannitol Salt Agar.

- a. All positive results on the above agar shall be confirmed by the coagulase test.

- b. Phage typing on selective positive cultures shall be run as described below
2. Streptococci
    - a. Hemolysis on blood agar (sheep blood) shall be observed. The relative number of hemolytic colonies and the number of  $\beta$  hemolytic colonies shall be recorded.
      - (1) Alpha hemolysis
      - (2) Beta hemolysis
      - (3) Gamma hemolysis
    - b. Growth on Mitis-Salivarius Agar shall be observed.
    - c. A differential sugars series shall be run if organisms are not identifiable under 1 or 2. Andrade's fermentation broth base or cysteine-trypticase semi-solid agar plus each of these compounds shall be used.
      - (1) Lactose
      - (2) Maltose
      - (3) Mannitol
      - (4) Inulin
      - (5) Dextrin
      - (6) Sorbitol
      - (7) Trehalose
    - d. Sero-typing on Beta hemolytic cultures shall be performed.
  3. Pneumococci
    - a. Bile solubility test described below shall be run.
    - b. Sero-typing shall be performed.
  4. Haemophilus

This organism shall be identified with typing antisera.

## 5. Neisseria

a. The Oxidase test described below shall be run. All Oxidase positives shall be sugar tested in Andrade's fermentation broth base or cysteine-trypticase semi-solid agar with each of the following compounds:

- (1) Dextrose
- (2) Maltose
- (3) Sucrose
- (4) Levulose
- (5) Mannitol

b. Serologic groupings shall be done.

## 6. Gram-Positive Rods

The test for Catalase (described below) shall be performed. Fecal anaerobes shall also be tested.

- (1) Catalase negative (suspicious lactobacilli) shall be confirmed on Rogosa's medium.
- (2) The following observations shall be made on the Catalase positive gram-positive rods.
  - (a) Sporulation shall be observed from spore stains or Gram stains.
  - (b) Tellurite medium (1% added to trypticase soy agar) shall be inoculated.
  - (c) Gelatin (Gall's or other) shall be inoculated.
  - (d) The Ziehl-Neelsen stain shall be run.
  - (e) Hemolysis on sheep blood shall be observed.
  - (f) Loeffler's Medium shall be inoculated.

(g) Fluorescence under Woods' light shall be observed.

#### 7. Gram-Negative Rods

All Salmonella-or Shigella-like colonies shall be isolated and definitively identified. The following media shall be inoculated:

- a. Triple Sugar Iron Agar medium
- b. SIM medium
- c. Methyl red Voges-Proskauer medium
- d. Simmon's citrate medium
- e. Urease medium
- f. Nitrate medium
- g. Litmus milk medium
- h. Gelatin (Gall's) medium
- i. Potassium cyanide medium
- j. Phenylalanine medium
- k. Tryptone broth or broth containing tryptophan
- l. KF medium
- m. Cytochrome oxidase tests (on all alkaline over alkaline TSI's) shall be run.
- n. Typing antisera (Shigella, Salmonella, Escherichia, Klebsiella) shall be used.

#### 8. Macroscopic and Microscopic Observations

Detailed procedures for differential staining and microscopic observations of these organisms are given in the section dealing with the isolation of microorganisms from the lunar sample.

## 9. SUBSIDIARY TESTING

### a. Phage typing

Twenty-two standard phages recommended by the International Subcommittee on Phage typing of staphylococcus shall be used. The phages are: 29, 52, 52A, 79, 80, 3A, 3B, 3C, 55, 71, 6, 7, 42E, 47, 53, 54, 75, 77, 83A, 42D, 81, 187, and UC-18. The methods recommended by the subcommittee shall be employed. Cultures shall be typed first with the routine test dilutions (RTD) of the phages. Those cultures which show no significant lytic reactions at RTD shall then be retyped with the phages in concentrations 1000 times stronger than RTD. The phage pattern, or "type" of a culture, if reported by listing those phages that produced significant lysis at either RTD or 100 x RTD, shall be recorded as nontypable if no lysis at 1000 x RTD.

### b. Serological and fluorescent antibody typing

- (1) Streptococcus
- (2) Haemophilus
- (3) Escherichia
- (4) Corynebacterium
- (5) Klebsiella
- (6) Leptospira
- (7) Mycobacterium
- (8) Neisseria
- (9) Pneumococcus
- (10) Proteus

(11) Salmonella

(12) Shigella

#### IV. REFERENCES

##### A. General

Gram-positive micrococci. "Diagnostic Microbiology" by Bailey and Scott.

Gram-negative micrococci. "Diagnostic Procedures and Reagents" from the American Public Health Association.

Gram-positive rods. "Diagnostic Microbiology" by Bailey and Scott.

Gram-negative rods. "Identification of Enterobacteriaceae" by Edwards and Ewing, Communicable Disease Center, Atlanta, Georgia.

Acid-fast bacilli. "Procedures for the Identification of Acid-Fast Bacilli" from the Communicable Disease Center, Atlanta, Georgia.

Davidsohn, I. and B. B. Wells, eds., 1962. Todd - Sanford's Clinical Diagnosis by Laboratory Methods, 13th ed. Philadelphia, Pennsylvania, W. B. Saunders.

Lynch, M. J., S. S. Raphael, L. D. Mellor, P. D. Spare, P. Hills, and M. J. H. Inwood. 1963. Medical Laboratory Technology. Philadelphia, Pennsylvania, W. B. Saunders.

Frankel, S. and S. Reitman, eds. 1963. Gradwohl's Clinical Laboratory Methods, 6th ed., St. Louis, Missouri, C. V. Mosby.

Bailey, W. R. and E. G. Scott. 1966. Diagnostic Microbiology, 2nd ed. St. Louis, Missouri, C. B. Mosby.

**B. Fluorescent Antibody Techniques**

Aoki, S., M. Merkel and W.R. McCabe, 1966. Immunofluorescent Demonstration of the Common Enterobacterial Antigen. *Proceedings of the Society for Experimental Biology and Medicine.* 230-234.

Beutner, E.H. Immunofluorescent Staining: The Fluorescent Antibody Method. *Bacteriological Review* 25: 49-76.

Chalvardjian, N., 1966. The Laboratory Diagnosis of Whooping Cough by Fluorescent Antibody and by Culture Methods. *Canadian Medical Association Journal.* 263-266.

Coons, A.H., J.C. Snyder, F.S. Cheever, and E.S. Murray, 1949. Localization of Antigen in Tissue Cells. *J. Exptl. Med.* 91: 31-37.

Goldstein, G., I.S. Slizys, and M.W. Chase, 1961. Studies on Fluorescent Antibody Staining. *J. Exptl. Med.* 114: 89-109.

Goldstein, G., B.P. Spalding, W.B. Hunt, Jr. Studies on Fluorescent Antibody Staining II. Inhibition by Sub-Optimally Conjugated Antibody Globulins. *Proc. Soc. Exptl. Biol. Med.*

Hiramoto, R.N. and M. Hamlin, 1965. Detection of Two Antibodies in Single Plasma Cells by the Paired Fluorescence Technique. *Journal of Immunology* 95(2): 214-224.

Hokenson, E.O. and P.A. Hansen, 1966. Flazo Orange for Masking of Auto and Nonspecific Fluorescence of Leukocytes and Tissue Cells. *Stain Technology* 41 (1): 9-14.

Klugerman, M.R., 1966. Chemical and Physical Variables Affecting the Properties of Fluorescein Isothiocyanate and Its Protein Conjugates. *Journal of Immunology* 95(6): 1165-1173.

McDevitt, H.O. and A.H. Coons. Methods for Preparation of Fluorescent Proteins. *Methods in Medical Research* 10: 142-148.

McKinney, R.M., J.T. Spillane and G.W. Pearce, 1964. Factors Affecting the Rate of Reaction of Fluorescein Isothiocyanate with Serum Proteins.

Myers, J., A.U. Sargent and J.J. Cohen, 1965. Whole Antiserum Versus the Gamma-Globulin Fraction of Anti-serum in the Indirect Fluorescent Antibody Technique. *Immunology* 9(2): 101-105.

Pital, A., S.L. Janowitz, C.E. Hudak, and E.E. Lewis, 1966. Direct Fluorescent Labeling of Microorganisms as a Possible Life-Detection Technique. *Applied Microbiology* 14(1): 119-123.

**Fluorescent Antibody Techniques, Con't**

Rinderknecht, H., 1960. Ultra-Rapid Fluorescent Labeling of Proteins. *Separatum Experientia* 16(9): 430.

Spendlove, R.S., 1966. Optimal Labeling of Antibody with Fluorescein Isothiocyanate. *Proceedings of the Society for Experimental Biology and Medicine* 122: 580-583.

Tateno, I., S. Suzuki, S. Nakamura, O. Kitamoto, A. Kawamura, Jr., M. Makino, Y. Takeuchi, and T. Sonoguchi, 1965. Rapid Diagnosis of Influenza by Means of Fluorescent Antibody Technic. *The Japanese Journal of Experimental Medicine* 35(5): 383-400, 401-410, and 411-417.

White, J.D. and M.H. McGavran, 1965. Identification of Pasteurella tularensis by Immunofluorescence. *JAMA* 194(3): 180-182.

Wood, B.T., S.H. Thompson and G. Goldstein, 1964. Fluorescent Antibody Staining. *Journal of Immunology* 95(2): 225-229.





microscope. Smears and flood films shall be stained with Giemsa's stain. Fluorescent antibody tests shall be examined microscopically to determine fluorescence.

#### V. IDENTIFICATION

Organisms shall be recognized by their characteristic spiral morphology, fluorescent antibody absorption reactions, and other serological tests if necessary.

#### VI. REFERENCES

Galton, M.M., R.W. Menges, E.B. Shotts, Jr., A.J. Nahmias and C.W. Heath, Jr. 1962. USPHS Publication 951.

Stuart, R.D. 1946. J. Path. Bacteriol. 58, 343-349.

Bailey, W. and E. Scott. 1966. Diagnostic Microbiology, 2nd Ed. 196-199.

Deacon, W.E., J.B. Lucas and E.D. Price. 1966. The Fluorescent Treponemal Antibody Adsorption (FTA-ABS) Test for Syphilis. J. Am. Med. Assoc. 156-160.

Knox, J.M., D.H. Short, R.D. Wende and J.M. Glicksman. 1966. The FTA-ABS test for syphilis performance in 1,033 patients. Br. J. Ven. Dis. 42: 16-20

## MYCOPLASMA

### I. METHOD OF COLLECTION

Samples collected from the crew (eye, nose, gingiva, throat, penis, and urine) shall be cultured for mycoplasma.

### II. PRIMARY CULTURING

Specimens to which no antibiotics have been added shall be studied. Antibiotics to be specifically excluded are all of the tetracyclines, chloramphenicol, erythromycin, streptomycin, and kanamycin.

#### A. Media

1. PPL0 agar containing horse serum (not heat inactivated) and yeast extract.
2. PPL0 broth containing horse serum (not heat inactivated) and yeast extract.

Penicillin (1,000 units/ml, amphotericin B 5  $\mu$ g/ml, and thallium acetate (1:2000) shall be added to these media.

#### B. Procedures

1. Duplicate plates and broth tubes (2 ml) shall be inoculated with a sample of each specimen. The plates shall be sealed (with paraffin 90%, vaseline 10%, or other appropriate seal).
2. Both plates and broth tubes shall be incubated aerobically and unsealed plates incubated anaerobically.
3. Tubes and plates should be examined every 3 days, the plates under 35 X magnification.

### III. SECONDARY CULTURING

Specimens from primary culturing media, animals, embryonated eggs, and tissue cultures, shall be put into antibiotic free media as designated

under the section on Primary Culturing.

Mycoplasma isolates should be transferred several times serially in broth suspension, tested for bacterial contamination by gram stain and subculture, and then stored in small aliquots at  $-80^{\circ}\text{C}$ .

#### IV. MICROSCOPIC EXAMINATION

Colonies appearing on solid agar shall be studied by the technique of Dienes for morphologic characteristics.

#### V. IDENTIFICATION (SEROLOGIC TESTING)

- A. Isolates shall be tested with a variety of antisera against known mycoplasma stains by the technique of Clyde (1964).
- B. Serum from crew members and animals inoculated against a variety of mycoplasma stains shall be tested by the technique of metabolic inhibition of Taylor-Robinson et al., (1966).
- C. The sera in V-B shall also be tested by the technique of colony-forming unit reduction, as follows:

Broth cultures, frozen in small aliquots, should provide mycoplasma suspensions of reproducible titer. The suspension shall be diluted to contain  $4 - 12 \times 10^4$  CFU/ml. For tests requiring heat labile serum component(s), pooled normal guinea pig serum frozen in small aliquots immediately after collection shall be used. An aliquot of this serum first shall be titrated in the presence of excess antibody. For later use in the test, the serum shall be diluted to provide approximately 4 times the minimal effective dose. Dilutions shall be made in PPL0 broth without serum, but containing 0.003 M Mg ( $\text{MgCl}_2$ ) and 0.00015 M Ca ( $\text{CaCl}_2$ ).

The test system shall consist of 0.2 ml of the culture dilution, 0.1 ml of diluted rabbit immune serum, and 0.1 ml of either diluted guinea

pig serum or broth. Mixtures should be incubated at 35°C for varying intervals. Aliquots shall be transferred from each tube to PPL0 agar plates containing heated horse serum. A 2 mm platinum loop designed to deliver 0.005 ml shall be used.

Colony counts shall be made after 3-10 days incubation, using a microscope providing 35 X magnification.

Note: This is an alternate method for growth inhibition developed by Dr. Riggs.

Complement fixation testing of antibodies in crews is a more widely accepted clinical procedure.

#### VI. REFERENCES

- Hayflick, L., 1965. Tissue cultures and Mycoplasmas. Tex. Rep. on Biol. Med. Suppl. 1: 23, 285-303.
- Chanock, R. M., Hayflick, L., and Barile, M.F. Proc. National Academy of Sciences U.S. 1962: 48, 41.
- Clyde, W.A., June, 1964. J. Immunology 92: 958.
- Taylor-Robinson, et al., 1966. J. Hyg. Camb. 64: 91.
- Crawford, Y.E., 1966. A Laboratory Guide to the Mycoplasmas of Human Origin. Naval Med. Res. Unit # 4, MR 005.09-0024 R.U. 66.25.
- Ford, D.K., 1967. Relationships between mycoplasmas and the etiology of nongonococcal urethritis and Reiter's syndrome. N.Y. Academy of Science 2nd Conference on Biology of Mycoplasmas. Ann. N.Y. Acad. Sci. In Press.

## FUNGI AND ACTINOMYCETES

### I. METHOD OF COLLECTION

The procedures for areas and methods of collection are the same as those given for bacteria.

### II. PRIMARY CULTURING

The broth tubes containing the aerobic and anaerobic swabs collected for the Bacteriology section shall be used as an inoculum for the following media:

- A. Sabouraud's medium
- B. Thompson's cystein blood agar
- C. Actinomyces agar
- D. Phytone yeast agar
- E. Czapek-Dox agar
- F. Sabhi-blood agar
- G. Brain-heart cyclohexanide chloroamphenicol medium
- H. Pagano Levin agar or YM agar (for yeasts)
- I. Mycobiotic agar

The media used for isolation of bacteria (i.e., blood agar, thioglycolate, phytone yeast extract, etc.) shall also be monitored for fungi.

Plates shall be incubated aerobically and anerobically. The temperatures of incubation shall be room temperature, 30° and 35°C. Post-flight incubation shall include 4° and 18°C.

### III. SECONDARY CULTURING

The procedures given under the section on Isolation of Fungi from the Lunar Sample shall be followed. Animal inoculation is also suggested, if

indicated.

#### IV. IDENTIFICATION

Plates and tubes shall be observed daily; growth shall be transferred, picked, isolated in pure culture, and identified according to standard procedures

#### V. REFERENCES

- Ajello, L., Georg, L.K., Kaplan, W., and Kaufman, L. 1963. CDC manual for medical mycology. P.H.S. Publ. 994, U.S. Govt. Printing Office, Washington, D.C.
- Bessey, E.A. 1950. Morphology and taxonomy of fungi. McGraw Hill Co., New York, N.Y.
- Alexopoulos, C.J. 1962. Introductory mycology. 2nd Ed. John Wiley & Sons, New York, N.Y.
- Conant, N.F., Smith, D.T., Baker, R.D., and Callaway, J.L. 1954. Manual of clinical mycology, 2nd Ed. W. B. Saunders Co. Philadelphia, Pa.
- Emmons, C.W. Binford, C.H., and Utz, J.P. 1963. Medical mycology. Lea and Febiger, Philadelphia, Pa.
- Lewis, G.M., Hopper, M.E., Wilson, J.W. and Plunkett, O.A. 1958. An introduction to medical mycology, 4th Ed. Year book Medical Publishers, Inc., Chicago, Illinois.
- Harris & Coleman, Eds. 1963. Diagnostic Procedures and Reagents. American Public Health Association, Inc., New York, N. Y.

## PROTOZOA AND HELMINTHS

If there is any possible effect of lunar exposure on a parasitemia, and if this effect is to be demonstrated, it is suggested that a two-week pre-exposure study is not unreasonable. Post-exposure study will, of course, have its duration dictated by the findings, or lack thereof.

Most of the present-day astronauts are servicemen or ex-servicemen who have served in parts of the world where parasitism is an everyday problem, and several of them may have any number of "exotic" parasites--such as malaria organisms (Plasmodium), schistosomes, flukes, or cestodes.

### I. AREA OF COLLECTION

Samples shall be taken from the following areas as designated under crew bacteriology:

- A. Gingival margin or the gum
- B. Blood
- C. Urine
- D. Feces
- E. Perianal region (Scotch tape)

### II. EXAMINATIONS

#### A. Oral

1. The only parasitism to be expected would be found in the trophozoite stage, such as Entamoeba gingivalis and Trichomonas tenax.
2. Diagnosis shall be made by direct demonstration of trophozoites under light microscopy, using material removed from between the teeth, from the gingival margin of the gums, or from dentures.

#### B. Intestinal

1. Routine stool examinations for trophozoites, cysts of protozoa,



and "eggs" of helminths usually include the following:

- a. Direct examination of fecal samples
  - b. Examination of preserved stained films of stools
  - c. Concentration techniques
2. Direct examination of unstained films shall be used in the determination of living parasites, such as motile protozoan trophozoites, helminth "eggs," and nematode larvae.
  3. Iodine staining of fresh films shall be employed primarily to aid in the determination of diagnostic features of protozoan cysts.
  4. Polyvinyl alcohol (PVA) shall be used to preserve stool specimens. Preserved specimens shall be processed and stained for microscopic examination.
  5. Iron-hematoxylin is the stain of choice for preserved films.
  6. The zinc sulfate centrifugal-flotation technique shall be used to concentrate the sample. Since this is not satisfactory for operculate helminth "eggs," nor for those of schistosomes, an acid-ether concentration method shall also be employed.
  7. Thorough examination for intestinal helminths should also include an anal swab (Scotch tape) for demonstration of the rather common Enterolius vermicularis.
  8. When direct methods of stool examinations are unrewarding, the following methods shall be used:
    - a. Nelson's medium for amoebae
    - b. Hogue's medium for intestinal flagellates
    - c. Balamuth's medium for amoebae
    - d. NNN medium for tapeworms

### C. Urine

1. This is the common excretion in which "eggs" of Schistosoma haematobium are voided. The pathogenic flagellate, Trichomonas vaginalis, is not infrequently seen in urine sediment from infected males.
2. Concentration techniques shall be used and the sediment observed under light microscopy.

### D. Blood

1. Next to feces the blood forms the most common medium for recovery of animal parasites. In blood, diagnosis is routinely made for malaria, trypanosomiasis, and most types of filariasis.
2. The standard procedure for diagnosis of blood parasites shall be used. Slide preparations of both thick and thin films shall be made and examined microscopically.
3. Giemsa's stain shall be used for blood films.

## III. REFERENCE

Andrade, Z.A., F. Paronetto, and H. Popper, Immunochemical studies in schistosomiasis, *Am. J. Path.* 39 (5): 589-598.

Coleman, R.M., 1961, In vivo antibody binding sites in Hymenolepis nana as demonstrated by direct and indirect immunofluorescent staining, *J. Parasit.* 47: 54.

Craig, C.F. and E.C. Faust, 1964, *Clinical Parasitology*, 7th edition, Lea and Febiger, Philadelphia, Pa.

Goldman, M., R.V. Carver, and N.N. Gleason, 1960, Antigenic analysis of Entamoeba histolytica by means of fluorescent antibody. II. Entamoeba histologica and Entamoeba hartmanni, *Exptl. Parasit.* 10: 366-388.

Goldman, M. and N.N. Gleason, 1961, Antigenic relationship of two strains of Entamoeba histolytica and one of Entamoeba hartmanni as shown by

cross-sorption of fluorescent antisera to each strain. J. Parasit.  
47: 29.

Mueller, J.F. and J.F. Rice. "The Nature of Tropical Diseases,  
Diagnostic Procedures and Reagents, 4th edition, American Public  
Health Association.

## VIRUSES

### I. METHOD OF COLLECTION

Collection of specimens should be coordinated with protocols for bacteria and mycoplasma, but penicillin and streptomycin should be added to collection media for viruses. Note the sensitivity of the material for culture of bacteria. See Table II, MICROBIOLOGY SECTION.

#### A. Conjunctival swab\*

##### 1. Method and procedures

An applicator shall be lubricated with veal infusion broth and then used to swab the conjunctival sac between palpebral and bulbar conjunctiva so as to occlude the nasolacrimal duct. This is stored in 3 ml veal infusion broth containing 0.5% bovine serum albumin and eluted by twirling for 30-60 seconds.

##### 2. Time

Three different days.

#### B. Nasal washing

##### 1. Method and procedures

5 ml veal infusion broth (Difco) containing 0.5% bovine albumin shall be instilled into each nostril with the head tilted back and the glottis closed. The head is then brought forward and the media and secretions are allowed to run into a sterile beaker or cup. The washings shall then be mixed

---

\* The cotton swabs shall give a neutral reaction in distilled water. Some brands are acid and this acidity may inactivate the viruses.

Insonation shall be recommended as an alternate method for recovering viruses from swabs and specimens.

thoroughly by swirling and placed in suitable container for storage and testing. After the sample is collected, 100 units/ml penicillin, 100 micrograms/ml streptomycin and 20-200 units/ml nystatin shall be added.

2. Time

Every other day.

C. Throat swab

1. Method and procedures

A dry cotton applicator shall be used for swabbing the throat. Both the tonsillar regions and the posterior pharyngeal wall shall be swabbed. This applicator shall be placed in a veal infusion broth tube and eluted as indicated in A.

2. Time

Every other day.

D. Anal swab

1. Method and procedures

The buttocks shall be spread. A cotton applicator shall be inserted about 2-3 inches into rectum and the rectum gently swabbed. Small amounts of surgical jelly may be used on the swab if necessary. The swab shall be placed in 2 ml veal infusion broth contained in a sterile tube or eluted as in 1.

2. Time

Every other day.

E. Stool specimen

1. Method and procedures

The specimens shall be homogenized in Melnick's M-E medium

or Hank's Balanced Salt Solution\* to make a 10% suspension.

2. Time

Three different days.

F. Blood

1. Methods and procedures

10 ml of blood shall be collected. The blood may either be heparinized or laked by freezing in alcohol and dry ice. If heparinized blood is used, erythrocytes, leucocytes, and plasma shall be tested.

2. Time

Three different days.

If possible, immunological studies shall be performed to determine immuno-globulin patterns and antibody titers (CF).

G. Urine

1. Methods and procedures

Mid-stream samples (10 ml) shall be collected. The urine shall be neutralized before testing.

2. Time

Three different days.

H. Reference

Schmidt, N.J., 1964. Tissue Culture Methods and Procedures for Diagnostic Virology in Lennette, E.H. and Schmidt, N.J., eds., Diagnostic Procedures for Viral and Rickettsial Diseases. American Public Health Association, Inc., p.150.

---

\*Hank's Balanced Salt Solution (Hank's BSS). Melnick's M-E medium consists of 0.5% lactalbumin hydrolysate in Earle's salt solution, with 100 units/100 micrograms penicillin/streptomycin per ml. Earle's salt solution consists of the salts listed under Eagle's medium in the appendix.

## II. CONCENTRATION OF SAMPLE

Concentration of specimens will greatly enhance sensitivity of virus detection. The extracts in volumes greater than 5 ml shall be concentrated to 1 ml by  $Al(OH)_3$  concentration, Millipore adsorption, ultracentrifugation (Density Gradient), Vacuum, or Carbowax. Most of these techniques are described in detail in the appendix.

Similarly, after concentration, the aliquots of the concentrate (Millipore adsorption) shall be examined by electron microscopy.

## III. ANIMAL SYSTEMS

### A. Preference List

Animals shall be bled prior to inoculation. Large animals shall be bled from the femoral vein, (swine, calves, dogs, juvenile monkeys), smaller animals from the heart (adult hamsters, adult mice, guinea pigs, rats, rabbits, cats, ferrets). Newborn animals shall not be bled. Size of baseline samples which shall be obtained are given in the table in section 5. It is preferable to separate blood into serum and erythrocytes and store both. The same number of uninoculated animals as inoculated shall be kept as controls.

All animals shall be pathogen-free. In addition, germ-free animals shall be used which have no radiation-induced leukemia.

- |                                |           |
|--------------------------------|-----------|
| 1. Mouse (newborn & adult)     | 7. Rat    |
| 2. Monkey (newborn & juvenile) | 8. Rabbit |
| 3. Hamsters (newborn & adult)  | 9. Calf   |
| 4. Guinea pig                  | 10. Cat   |
| 5. Ferret                      | 11. Swine |
| 6. Dog                         |           |

Mice alone would be sufficient if specimens did not contain certain viruses that infect monkeys and not mice, (i.e., mumps and poliovirus) or infect hamsters and not mice (i.e., adenovirus).

## B. Routes of injection

### 1. Mice

The routes of inoculation for mice which shall be used are:

- |                            |                           |
|----------------------------|---------------------------|
| a. Intracerebral, (i.c.)   | g. Oral                   |
| b. Intraperitoneal, (i.p.) | h. Intramuscularly (i.m.) |
| c. Intravenous, (i.v.)     |                           |
| d. Intranasal, (i.n.)      |                           |
| e. Intracutaneous          |                           |
| f. Subcutaneous, (s.c.)    |                           |

### 2. Other animals

If animals other than mice are used, the routes of inoculation in order of decreasing importance for each are:

- a. Hamsters - intraperitoneal and/or intravenous
- b. Monkeys - intravenous
- c. Guinea pig - intraperitoneal
- d. Rabbit - intracutaneous
- e. Ferrets - intranasal



C. Size of inoculum

The sizes of inocula which shall be used are:

<u>Animal</u>	<u>Baseline Blood Sample (ml)</u>	<u>Size of Inoculum*</u> (ml)					
		I.C.	I.P.	I.M.	I.V.	1-CUT S-CUT	I.N.
Mouse	0.1						
Newborn		0.02	0.05	0.05	0.05	0.05	Wash
Adult		0.03	0.1	0.1	0.5-1.0	0.1	Wash
Hamsters							
Newborn		0.03	0.05	0.05			
Adult	0.2	0.05	0.2 (1-5)	0.02	1-5		
Guinea Pig	0.5	0.05	1-5	0.2		0.1	
Rat	0.5	0.05	1-2	0.2			
Rabbit	5.0	0.1	3-5	1-2			
Calf	20.0	1-2	20-40	2-10			
Dog	10.0	0.5	1-10	1-3			
Cat	5.0	0.5	1-5	1-3			
Ferret	5.0	0.1	1-5	1-3			0.2
Monkeys							
Newborn		0.5	2-5	1-3			
Juvenile	0.5	1.0	3-10	1-5			
Swine	20.0	1.0	5-15	2-10			

\* Variations in volumes of inoculum are based on size of animal.

#### D. Observation

##### 1. Macroscopic

Animals shall be observed frequently for symptoms of illness.

##### 2. Microscopic

Initial tissue specimens from sick animals used for blind passage shall be examined for virus particles under the electron microscope. Special electron microscopy techniques (grid preparation, staining, etc.) are given in the appendix.

#### E. Blind Passage

Blind passage of animal materials shall be made at least 3 times. The brain, liver, lungs, kidneys, spleen, and samples of muscle tissue shall be homogenized (individually) and inoculated into the same animal species using the same routes (and volumes of inoculum) as initially.

These may also be combined using 10% suspension of brain material from intracerebrally injected animals and 10% suspension of vital organs from I.V. or I.P. injected animals.

#### F. Bound Virus

Tests for bound virus shall also be run on all body excretions and available fluids. These procedures are listed in the appendix.

### IV. TISSUE CULTURE

#### A. Cell Lines

The tissue cultures are listed in order of preference. All cultures are necessary.

It is suggested that tissue culture cells be tested for the presence of mycoplasma which may alter the results of isolation attempts.

All of the details of tissue culture technique, including preparation of media, use of roller drums, transfer of materials, hemadsorption techniques, and a list of where necessary supplies can be obtained are provided in:

Schmidt, N.J. 1964. Tissue Culture Methods and Procedures for Diagnostic Virology in E.H. Lennette and N.J. Schmidt, eds.: Diagnostic Procedures for Viral and Rickettsial Diseases. American Public Health Association, Inc., pp. 78-176. Some of these methods are also given in detail in the appendix.

1. African Green Monkey Kidney
2. Rhesus Monkey Kidney
3. Human embryonic fibroblasts, WI-38
4. Human amnion
5. Human embryonic kidney
6. Human Cancer cultures: HeLa, KB, Hep-2
7. Hamster Kidney
8. Rabbit Kidney
9. Bovine Kidney
10. Bovine Spleen
11. Canine Kidney
12. Feline Kidney
13. Guinea Pig Kidney
14. Chick embryo fibroblasts
15. Mouse embryo fibroblasts
16. Rainbow Trout gonad

CDC suggest 1-7 and 14. They feel that chick embryo fibroblasts

may be superior for isolation of arboviruses.

B. Size of Inoculum

A 0.4 ml specimen or suspension shall be used as an inoculum.

C. Temperatures of Incubation

Tissue cultures shall be incubated at 4°C, 22°C, 35°C and 40°C.

C.D.C. suggests only using 33°C and 37°C.

D. Method of Incubation

These tissue culture lines shall be grown in roller drums.

E. Media

Media conventionally used for certain primary cell and stable cell lines shall be used for maintenance of cell lines. Thus, Melnick's M-E medium, Eagle's medium, or Mixture 199 can be used with serum (preferably bovine fetal) for most all of the cell lines used in this study. See the virology appendix for the list of media and formulas.

No unusual procedures are necessary. The biological requirements of cell lines are well known and the different media for the different cell lines are readily available.

F. Helper Viruses

Several tissue cultures of each set shall be co-infected with these known potential helper viruses.

1. Adenoviruses
2. Lymphocytic chorio-meningitis virus
3. Hog cholera virus

G. Enhancement Methods

### 1. Additives

Additional tissue culture cells should be treated with certain additives that are known to enhance the growth and plaque formation of earth-bound viruses.

- a. 25 mM  $MgCl_2$
- b. 1 mM cysteine
- c. 1:50 - 1:150 pancreatin
- d. 400 mg/ml protamine sulfate

### 2. Nucleic acid inhibitors

Nucleic acid inhibitors shall be added to block normal nucleic acids and allow the viral nucleic acids to take over.

- a. 200  $\mu M$  - 2 - (alpha - hydroxy-benzyl) -benzimidazole
- b. 60  $\mu g/ml$  - guanidine
- c. 100  $\mu g/ml$  - 5-iodo-2' desoxyuridine\*

### 3. Reagents which enhance infectivity

Similarly, specimens shall be treated prior to inoculation with certain reagents known to enhance infectivity of certain conventional viruses.

- a. 1M  $MgCl_2$  at 50°C
- b. 1% solution of proteolytic enzymes (trypsin, pancreatin, etc.) at 37°C for 1 hour.

## H. Carrier Cultures

Prolonged incubation and serial passage of tissue culture cells

---

\* CDC feels that this is not a good choice as it inhibits viral nucleic acid as well.

shall be maintained as carrier cultures. Fluids from prolonged incubations shall be examined for viruses by electron microscopy and tested for interference against known viruses.

Echovirus type 11, poliovirus type 1, and Newcastle Disease Virus shall be used. Vesicular stomatitis is more useful for interference studies but may not be readily available. These viruses are available from the American Type Culture Collection, Washington D.C., or Department of Virology, Baylor University College of Medicine.

After treatment of certain cultures with various specimens, the cultures are infected with known viruses (as above) to determine if they proliferate as profusely in specimen-treated cultures as they do in untreated, control cultures.

#### 1. Observations

##### 1. Microscopic

- a. Each culture shall be observed daily microscopically for cytopathic effect with subpassage as needed.
- b. Each culture shall also be examined by electron microscopy.

##### 2. Hemadsorption tests

These shall be performed at various time intervals during the incubation period using the following erythrocytes:\*

- a. Guinea pig
- b. Human O
- c. Sheep
- d. Fowl
- e. Monkey

---

\* CDC suggests only the use of guinea pig erythrocytes.

No special equipment is necessary for hemadsorption tests. Procedures for hemadsorption are fully described in current literature and are simple and accepted routines in virus laboratories. These methods are given in the Virology Appendix.

J. Sub-passage

Sub-passages shall be performed if cytopathic effects are noted. Blind passage X3 or more shall be performed if 1 & 2 are negative for a total of not less than 30 days. The procedures are the same as those under the virus sub-passage section.

K. Source

Tissue cultures may be obtained from several commercial sources:

1. Hyland Laboratories, Los Angeles, California
2. Microbiological Associates, Bethesda, Maryland
3. Flow Laboratories, Bethesda, Maryland
4. Difco Laboratories, Detroit, Michigan

V. EMBRYONATED HEN'S EGGS

Body excretions and available fluids shall be inoculated into embryonated hen's eggs. Germ-free eggs shall be used. Rigid testing is necessary for mycoplasma. Eggs shall be obtained on the day they are laid (day 0) and then placed in a humidified egg incubator at 38°C for the days required. Eggs are then candled to determine viability and then are inoculated.

A. Inoculation

1. Size of Inoculation

0.1 ml/egg shall be used for any of the routes.

2. Routes of inoculation and incubation (minimum of 6 experimental eggs and 6 controls for each variable shall be used).

<u>Route</u>	<u>Embryo Age</u>	<u>Incubation</u>
Amniotic sac	10 - 11 days	48 - 72 hrs
Allantoic cavity	10 - 11 days	24 72 hrs
Chorioallantoic membrane	10 - 12 days	48 - 72 hrs
Yolk sac	5 - 7 days	48 - 72 hrs*

Eggs shall be incubated stationary at 4°C, 25°C, and 35°C. CDC suggests 33°C and 37°C only and comments that 33° alone might suffice.

B. Observation

1. Death

Death of eggs can be detected visually by candling embryonated eggs during the course of incubation. The blood vessels retract and congeal and the embryo does not move every 10-15 seconds as do healthy embryos.

2. Pocks

Pocks can be observed macroscopically.

C. Harvesting

Eggs shall be harvested by chilling at 4°C for at least 4 hours. The shell shall then be opened and samples of allantoic fluids, amniotic fluids, yolk sac, chorioallantoic membrane and embryo shall be taken for additional blind passage or hemagglutination tests.

---

\* Longer incubation may be necessary for some viruses.



1. Allantoic fluid

This shall be aspirated from the allantoic cavity through a trephined section with a pipette.

2. Amniotic fluid

The fluid shall be aspirated from the amniotic sac with a pipette.

3. Yolk sac

The yolk sac shall be collected by suction with a pipette.

4. Chorioallantoic membrane

The membrane is removed surgically and then placed in a mortar and ground with alundum or placed in a Waring Blendor. The homogenized membrane is taken up in a diluent (veal-infusion broth) for use in further passage (blind) or for hemagglutination tests.

- D. Blind Passage

The various fluids will be used for blind passage in animals and eggs.

- E. Identification

1. Hemagglutination

Viruses can be identified by hemagglutination tests using the following: \*

- a. Human O cells
- b. Rhesus MK cells
- c. Sheep cells

---

\* CDC suggests only the use of guinea pig cells.

d. Guinea pig cells

e. Fowl cells

f. Rat cells

Hemagglutination, not hemadsorption tests are performed. These are standard, simple procedures carried out routinely by all virus and diagnostic laboratories. See Virology Appendix for methods.

## 2. Microscopy

### a. Light microscopy

The yolk sac shall be examined by light microscopy for Chlamydraceae (Bedsonia).

### b. Electron microscopy

Electron microscopy techniques shall be used to observe and identify viruses. See the appendix for procedures. In general, however, visualization of virus particles by electron microscopy would not seem to be a significant approach to the problem, as viruses can be detected and identified by other more economical tests included in the protocol.

## F. Source

Eggs can be obtained from Texas A&M, College Station, Texas.

## G. References

Details concerning procedures for use and maintenance, incubation periods, size of inoculum, harvesting procedures, etc., are presented in:

E.H. Lennette: General Principles Underlying Laboratory Diagnosis.  
Viral & Rickettsial Infections in E.H. Lennette & N.J. Schmidt.  
Diagnostic Procedures for Viral & Rickettsial Diseases. American  
Public Health Association, Inc., pp. 58-64, 1964.

PROTOCOLS FOR THE RECOVERY  
OF MICROORGANISMS FROM THE CREW

POST-FLIGHT TESTING PROCEDURES

The astronauts should be tested immediately after return and at least twice more during the first week after return by the same procedures given for pre-flight testing.\* Media for culturing possible lunar autotrophs shall also be used. All samples shall be cultured immediately (within 15 minutes). Special care should be taken that no one who is not surgically gowned shall come in contact with the returned astronauts until it is certain that these men are harboring no new microorganisms or pathogens. Until this is determined, the microbial profile of attendants shall be observed for possible pathogens or unknown microorganisms before release. Urine and feces not needed for analyses shall be destroyed. Any doubtful, possibly new microorganisms shall be characterized and must be proven non-pathogenic for the protocol test organisms (animals, plants, etc.) using standard procedures for detecting pathogenicity. Particular attention should be paid to microorganisms that have atypical colonies or growth patterns.

MICROBIOLOGY:

Since there will be no laboratory facilities in the quarantine trailer, the initial specimens shall be taken from astronauts and bagged. Samples of food, urine, and feces from the command module shall also be obtained. The use of a transport medium such as transport medium Anies or Stuart's transport medium is suggested. If there are no facilities aboard the recovery ship, a Trexler Isolette shall be set up to act as a sterile room. Previously prepared petri plates

---

\* The same procedures are used in post-flight analyses as outlined in the Pre-flight section. Slightly different methods of collection and observation are given for the Post-flight Virology protocol.

and tubes of media shall be inoculated from these specimens according to the procedures described in the section on pre-flight testing. The initial specimens shall be wrapped carefully, sealed in cans, and refrigerated with the viral samples. The petri plates and tubes shall be secured against breakage. All specimens and inoculated media shall be flown back to the Lunar Sample Receiving Laboratory for further incubation and examination.

#### VIROLOGY:

##### A. Primary sample collecting

Since no facilities will exist for immediate culturing for viruses, specimens shall be collected from the areas listed in the table below and shipped back to the Lunar Receiving Laboratory in Houston for viral culturing.

These samples shall be preserved in route as follows:

##### 1. Liquid N<sub>2</sub>

This is readily available and provides an ultra-cold temperature which is optional for preservation of unknown agents. However, glass-sealed ampules and a method of slowly dropping temperature to prevent glass breakage are required.

##### 2. Dry Ice (CO<sub>2</sub>)

This is also readily available but also requires glass-sealed ampules to prevent CO<sub>2</sub> leakage into specimens.

##### 3. Wet Ice (H<sub>2</sub>O)

This is the least effective preservative. It is probably adequate for most agents for a few hours. This procedure does

not require glass-sealed ampules. Screw-cap vials and other containers would be satisfactory.

NOTE: #3 is probably the best compromise.

B. Secondary sampling

Astronauts should be isolated for a minimum of 30 days and observed for any illness which might indicate possible viral infection.

After the astronauts are in the Lunar Receiving Laboratory, specimens shall be taken as follows:

<u>Specimen</u>	<u>Collection Medium</u>	<u>Time of Collection</u>
Conjunctival swab	Veal infusion broth	3 different days, first week; repeat, if indicated
Nasal wash	10 ml veal infusion broth	daily, first week, then every other day
Throat swab	10 ml veal infusion broth	daily, first week, then every other day
Anal swab	10 ml veal infusion broth	daily, first week, then every other day
Stool specimen* (As pre-flight)	None	all specimens first week; repeat if indicated
Blood, 10 ml, clotted	None	daily first week; repeat if indicated
Urine, 100 ml*	None	daily first week; repeat if indicated

If any illness develops, protocol will have to be modified accordingly. Each specimen is to be tested on each experimental system previously outlined.

---

\* Concentration of these specimens would greatly enhance sensitivity of virus detection system (ultracentrifugation or Millipore filter techniques).

Collection of specimens should be coordinated with protocol for bacteria and mycoplasma.

Penicillin, streptomycin and nystatin (20 units/ml for HeLa cells and 200 units/ml for monkey kidney cells) shall be added to collection media for viruses after sampling. Note the sensitivity of the material for culture of bacteria.

PROTOCOLS FOR THE RECOVERY OF  
MICROORGANISMS FROM THE ENVIRONMENT

PRE-FLIGHT TESTING PROCEDURES

I. AREAS OF COLLECTION

A. Command Module and LEM

1. Air
2. Communication equipment
3. Hatch
4. All couches
5. Switches
6. Floor under couches

B. Clothing

The suits and undergarments should be tested after thorough cleaning for residual organisms.

1. Suit and undergarment
  - a. Axilla
  - b. Crotch
  - c. Anus
  - d. Under or near cooling device
2. Socks
3. Boots
4. Helmet
5. Outgassing

C. Miscellaneous items

1. Personal hygiene ("wipettes," tooth brush, etc.)
2. Sanitary containers
3. Miscellaneous small equipment (lunar sampling tool, lunar sample container, cameras, etc.)
4. Personal items (mementos, etc.)
5. Flight plans, etc.

D. Food

E. Water

F. Fuel

II. METHODS OF COLLECTION

A. Command Module and LEM

After the last thorough cleaning, only those surgically gowned and booted shall enter to collect samples.

1. Air

- a. If the volume of air in the cabin is in excess of 2-300 L, the air shall be completely removed and sampled using a large volume air sampler such as an electrostatic precipitator. A 10-15 minute sampling period is sufficient.
- b. Alternatively, the cabin air shall be filtered for 10-30 minutes through (negative pressure) an HA (0.45  $\mu$ ) Millipore membrane (293 mm surface) into distilled water.
- c. If this equipment is not available, sedimentation plates shall be used for collection of bacteria and viral collection shall be eliminated. These plates shall be placed on one of the couches and under certain equipment to be chosen and opened for 30 minutes.



## 2. Sites

- a. Using cotton swabs, specimens shall be taken from the indicated sites. Three samples each shall be taken from the couches and the floor under the couches.
- b. The samples shall be collected using dry cotton swabs pressed heavily on the test sites and rolled over a 1" x 1/2" area.
- c. Three samples shall be taken from each couch and the floor under each couch. One sample shall be taken from each of the other areas listed in 1A.

### B. Clothing

Just prior to donning the suits and underwear, the specified areas shall be sampled by swabbing. If the socks are separate, two swabs shall be taken, one from the heel, the other from the toe area.

### C. Miscellaneous items

All items shall be sampled by swabbing.

### D. Food

Representative packets of each type of food taken on the flight shall be tested. Twenty (20) grams of the dehydrated sample shall be aseptically collected.

### E. Water

1. At least five 10 ml samples shall be taken aseptically for direct culturing.
2. Samples shall be taken aseptically and concentrated before culturing by Millipore filtration.

### F. Fuel

1. Samples shall be taken aseptically for direct culturing.
2. Samples shall be taken aseptically and concentrated by Millipore filtration before culturing.

### III. PRIMARY CULTURING

#### A. Command Module and LEM

##### 1. Air\*

###### a. Microbiology (other than viruses)

Two sets of sedimentation plates shall be placed on one of the couches and under various equipment.

The samples shall be cultured on the following media:

- (1) Blood agar (2-one incubated aerobically; one anaerobically)
- (2) Mac Conkey's agar
- (3) Phytone yeast, mycobiotic agar, or modified Sabouraud's medium.

###### b. Virology

- (1) Samples obtained from the large volume air sampler shall be cultured for virus as previously described in the Pre-flight Virus Protocol.
- (2) Alternatively, the membrane obtained from the Millipore air filtration procedure shall be assayed for viruses by inoculation into a variety of tissue culture systems as described in the Pre-flight Testing Protocol.

##### 2. Other sites

###### a. Microbiology (other than viruses)

The swabs shall be cultured in the following media:

---

\* Air samples shall also be cultured for microorganisms on the same media listed above for sedimentation plates.

- (1) Veal infusion broth
- (2) Trypticase-soy broth
- (3) Fluid thioglycollate

One tube shall be incubated aerobically and the other anaerobically. Fluid thioglycollate shall be incubated aerobically only.

b. Virology

Specimens (swabs) shall be taken from random sites in the Command Module and LEM. These swabs shall be placed in veal infusion broth. Aliquots shall be inoculated into various animals and tissue culture systems as outlined in the Pre-flight section on Virology.

B. Clothing

1. Microbiology (other than viruses)

Just prior to donning, all clothing shall be tested microbiologically as follows:

Media

- a. Swabs shall be placed in trypticase-soy or heart infusion broth and incubated aerobically and anaerobically.
- b. Duplicate swabs shall be placed in fluid thioglycollate and shall be incubated aerobically.

2. Virology

When sampling clothing, the procedures given under Primary Culturing 2B shall be followed.

C. Miscellaneous items

1. Microbiology (other than viruses)

Specimens shall be cultured as described in the Primary Culturing sections 1 and 2.

## 2. Virology

Specimens (swabs) shall be taken of miscellaneous items and placed in veal infusion broth, etc., as in Primary Culturing sections 1 and 2.

## D. Food

### 1. Microbiology (other than viruses)

#### a. The food samples shall be prepared for testing as follows:

Twenty (20) grams of the dehydrated sample is aseptically transferred to a sterile blender cup. Add 80 ml of chilled sterile distilled water and blend for three (3) minutes. This slurry constitutes a 1:5 dilution and contains the equivalent of 0.2 gm food sample per ml. Hereafter, this shall be termed Extract A. A fifty (50) ml aliquot of Extract A is transferred to a 50 ml chilled Sterile Buffered Water Blank (SBW:  $PO_4$  M/5, pH 7.0) and thoroughly mixed. This mixture constitutes a final dilution of 1:10 and contains the equivalent of 0.1 gm food sample per ml; the 1:10 dilution shall be termed Extract B. Both extracts shall be maintained at not greater than 40°F until used as prescribed in the following tests.

#### b. The media to be used are designated in Table 1 in the Pre-flight Crew Microbiology section, and will be inoculated with 0.1 ml of the slurry, suitably diluted for the total count.

- c. An alternate procedure for culturing food samples is found in the Space Food Prototype Production Guide Addendum, No. IA, U.S. Army Natick Laboratories, Natick, Massachusetts, May 1, 1965. This procedure is given in the appendix.\*

#### E. Water

##### 1. Microbiology (other than viruses)

- a. Fuel cell and drinking water will be tested by inoculating the media designated in Table 1 (Pre-flight Testing Procedures) with 0.1 ml of the water, suitably diluted 1:10 for the total count.
- b. An alternate procedure will be found in Standard Methods for the Examination of Water and Waste Water prepared by the American Public Health Association, Inc. (12th Edition, 1965). This is given in detail in the appendix.

##### 2. Virology

Water samples shall be concentrated and cultured by the techniques previously described in the Pre-flight Testing Crew Microbiology procedures.

#### F. Fuel

The fuel used in the LEM is unsymmetrical dimethyl hydrazine.

##### 1. Microbiology (other than viruses)

Samples shall be first filtered through a Millipore filter, washed, and the filter transferred to the designated media. Samples shall be cultured using the procedures given in the section on Pre-flight Crew Microbiology.

---

\*Another alternate procedure is found in Report of The Advisory Committee on the Microbiology of Frozen Foods, Association of Food & Drug Officials of the United States, Quarterly Bulletin, Supplemental Issue 1966, edited and published by The Editorial Committee, P.O. Box 1494, Topeka, Kansas 66603.

#### IV. SECONDARY CULTURING

##### A. Command Module and LEM

###### 1. Air

###### a. Microbiology (other than viruses)

Colonies picked from all of the agar plates shall be processed as outlined in the Pre-flight Microbiology section.

###### b. Virology

The procedures for processing samples listed under the Pre-flight Microbiology section shall be followed.

###### 2. Other sites

###### a. Microbiology (other than viruses)

Secondary cultures from broths shall be made on the following media:

###### (1) Aerobic

(a) Blood agar

(b) Mac Conkey's agar

(c) Phytone yeast agar, mycobiotic agar, or modified Sabouraud's medium.

###### (2) Anaerobic

The anaerobic broth cultures shall be transferred to blood agar plates only.

Colonies picked from these plates will be processed as outlined for Crew Microbiology.

###### b. Virology

The procedures for processing samples listed under the Pre-flight Microbiology section shall be followed.

**B. Clothing****1. Microbiology (other than viruses)**

- a. The aerobic broth shall be subcultured on blood agar, actinomyces media, Mac Conkey's agar, and phytone yeast (mycobiotic agar or modified Sabouraud's medium may be substituted).
- b. The aerobic broth shall be subcultured on blood agar incubated anaerobically.
- c. Cultures shall be processed as outlined in the Crew Microbiology Pre-flight section.

**2. Virology**

The procedures for processing samples listed under the Pre-flight Microbiology section shall be followed.

**C Miscellaneous items****1. Microbiology (other than viruses)**

Secondary cultures from broths shall be made on the media listed in the section on Secondary Cultures A2.

**2. Virology**

The procedures for processing samples listed under the Pre-flight Microbiology section shall be followed.

**D. Food, Water, and Fuel**

The procedures for secondary culturing are found in the standard analytical methods described earlier in this section under Primary Culturing. Viruses shall be similarly handled.

PROTOCOLS FOR THE RECOVERY OF  
MICROORGANISMS FROM THE ENVIRONMENT

POST-FLIGHT TESTING PROCEDURES

The exterior of the returned Command Module spacecraft shall be considered clean because of the high surface temperatures during reentry and because it was never in contact with the lunar surface. Since the interior of the Command Module will be potentially contaminated, the escape of "blow-off" atmosphere shall be prevented unless filtered. After exit of the astronauts and the two sealed sample boxes, the spacecraft shall be sealed and transported to the LRL for holding during the quarantine period. In the LRL the craft will be available for any essential post-flight examination. Command Module clothing, etc., shall be sterilized before release prior to handling. Waste food and water not needed for analyses should be destroyed. No viral analyses of food or fuel are necessary unless astronauts become ill. Food analyses shall be considered in this event.

I. AREAS AND METHODS OF COLLECTION

- A. Immediately post-flight and before removal of astronauts, the air of the Command Module shall be sampled.
- B. Post-flight sampling shall be conducted immediately before "contamination" can occur on various sites in the Command Module, the Command Module suits and underwear, and miscellaneous items, as outlined for pre-flight testing.
- C. Food and water discards and fuel samples shall be collected. The procedures given for pre-flight testing of environment shall be followed for sample collection.



LUNAR SAMPLE TESTING

## GENERAL RECOMMENDATIONS

1. To test the toxicity of the lunar material, both sterilized samples and unaltered material shall be compared. Sterilization pressure should be raised to 35 PSI to kill all spores. For example, in secondary culturing procedures using selective media, uninoculated media with and without the sterile lunar sample shall be used as controls. These shall distinguish purely chemical changes in the selective media which otherwise may be interpreted as resulting from growth.
2. The type of blood in blood agar is important. Rabbit or horse blood rather than sheep blood allow better growth of many genera and a wider spectrum of bacteria producing B-hemolysis. (Diagnostic Procedures and Reagents. Harris and Coleman. American Public Health Association, Inc., 1963. Page 133).

Sheep blood tends to inhibit the development of other organisms such as Haemophilus. In light of this, one must be aware of the limitations of this type of blood for general isolation procedures.

However, on secondary culture and especially detection of various types of hemolysis, sheep blood in sugar-free trypticase-soy is recommended. (Diagnostic microbiology, Bailey & Scott, 1966).

3. 5 - 10% CO<sub>2</sub> shall be mandatory for anaerobic culturing procedures.
4. Blood agar base which shall be used for these procedures:
  - a. Casman broth base
  - b. Brain-heart infusion broth

- c. Trypticase-soy, Tryptose blood agar base, or Tryptic soy
5. Standard media must always be used in parallel with inhibitory media. (Diagnostic Procedures and Reagents. Harris and Coleman. American Public Health Association, Inc., 1963, page 666).
  6. Plates should be dried before streaking and tested for sterility.
  7. Recommended standard incubator temperature for pathogenic microorganisms shall be 35°C. A major reason for not recommending 37° or 37.5°C is the safety factor, as a variation of 2°C would result in a dangerously high temperature, and pathogens grow as well at 35°C as at 37.5°C.
  8. Heat shocking at 75°C for 15 minutes + 100°C for 5 minutes shall be used to activate dormant bacterial spores.
  9. Color photography shall be used to record permanently routine work (ie. color changes in differential media). It is especially useful in noting the appearance of unusual colonies. Microscopic as well as the macroscopic records shall be taken. Stereophotography shall also be considered.
  10. The usual commercial N<sub>2</sub> gas has 0.1 of 1% O<sub>2</sub>. This is enough O<sub>2</sub> so that anaerobes will not grow. One must either use a 10% NaOH-pyrogalllic acid combination (carried by Fisher) or buy specially prepared N<sub>2</sub> gas which is scrubbed of the O<sub>2</sub>. Alkaline Methylene-Blue indicators should be in each incubator.

## CONTROL TESTING

It is advisable that all aspects of the protocol be tested long before the lunar samples are available. Optimally, experiments on simulated lunar materials shall be performed in the Lunar Receiving Laboratory. In this manner, the laboratory personnel shall become familiar with the operational procedures and specialized equipment so that the laboratory will run smoothly and efficiently.

In any event, it is mandatory that the personnel become thoroughly acquainted with the procedures which will be used to determine the presence of biological hazard(s) in the lunar samples.

### 1. Soil types

Special consideration shall be given to aseptic techniques and collection of soil types most likely to yield the greatest number of microorganisms.

Sand or fine particles are the easiest to handle. 4-6 mm particles are the upper limits for direct plating on media. Larger rocks require preliminary treatment; ie., crushing. Rocks which are very friable, porous, or easily crushed are acceptable. Hard obsidian-like rocks are poor samples both from the viewpoint of processing and the likelihood of containing microorganisms. Large rock samples in general are difficult to process and their collection shall be discouraged. The sampling device shall have an orifice that will accept only particles in or near the optimal size range. Subsurface samples or samples of the ground under large rocks are more likely to yield organisms than unprotected surface

samples.

2. Grinding

The survival of organisms exposed to various methods of grinding shall be investigated.

- a. Hand grinding vs mechanical devices
- b. Wet grinding vs dry grinding
- c. Sieving through fine stainless steel mesh screens

3. Suspension and agitation

The following parameters shall be studied:

- a. Washing before grinding
- b. Effect of final size of particles (eg: 2-6 mm vs fine silt) on optimal recovery of microorganisms
- c. Vortex agitation vs shaking of suspensions
- d. Speed of centrifugation
- e. Soil/diluent ratios
- f. Small individual samples vs large pooled and concentrated samples

4. Media concentration

Full-strength media shall be compared with various dilutions of the same media.

5. Plating methods

- a. Direct plating of soil shall be compared with samples from proposed centrifugation and extraction procedures.
- b. Pour plates shall be compared with streak plates.
- c. Growth in liquid and solid media of the same composition shall be compared.

d. Biphasic cultures shall be compared with liquid and solid media.

6. Concentration of organisms

Concentrations as low as 1-100 organisms/gram of soil shall also be tested for degree of recovery using the above variables of grinding, plating, etc.

a. Concentration by various flotation and liquid partition methods shall be tested, comparing processed and unprocessed soil samples. The use of organisms and spores of different sizes shall also be studied by these methods.

(1) Water

(2) Ludox

A shaking pre-incubation period of about three hours has been found to enhance the transfer of organisms from soil particles into this surrounding liquid menstrum.

(3) Polyvinyl alcohols

5% Dupont 72-60 polyvinyl alcohol plus 10% Pharmacia Dextran-250 shall be used. Certain mixtures of aqueous polymers tend to separate into two liquid phases. Particles in the micron range size (bacteria, viruses, etc.) tend to concentrate in one phase or the other.

b. Concentration by Millipore filtration of the above samples shall be studied.

c. The effect of pre-incubation before concentration on the total numbers recovered shall be determined.

## 7. Toxicity studies

### a. Sterile material

It would be of great advantage to have a "dry run" using autoclaved earth material, similar in physical and chemical properties to lunar materials, to test for toxicity in tissue cultures and animal systems. These shall include:

- (1) Sterile, pulverized rock of mixed composition
- (2) Sterile, mixed desert soil
- (3) Characterized desert soil containing known abundance and kinds of microflora

b. The possibility of infection after only brief exposures of tissue cultures to the lunar sample shall be examined, using a test system. Known amounts of virus particles shall be added to sterile soil samples. These shall be incubated with tissue cultures to permit viral adsorption for 2-4 hours and the soil then removed by washing.

## 8. Identification procedures

- a. Known, identified stock cultures of microorganisms which will grow and reproduce the required secondary differential reactions in the suggested culture media shall be used to test both the accuracy of the personnel doing the testing and the sensitivity of the test reagents.
- b. Uninoculated controls shall be included in all procedures.
- c. Control plates shall also be inoculated with same type of sterile material (soil, sand, or liquid) so that the manipulations of the person doing the sampling can be evaluated and some control on possible contamination can be achieved.

PROTOCOLS FOR THE RECOVERY OF  
MICROORGANISMS FROM THE LUNAR SAMPLE

CULTURING PROCEDURES

It should be emphasized that it is entirely possible to exhaust all of the sample supply in the performance of quarantine tests for organisms. There is no universal medium for culturing and growing all known terrestrial organisms. There is no single test which can be reliably performed to detect only one organism or a very low abundance of organisms when they are irregularly distributed or protected and enclosed by minute soil or rock structures in a large quantity of nonviable materials. In general, there is a correlation between particle size and viable count. A difference of one or two orders of magnitude exists between the count/gram in the <44 micron fraction compared with the >210 micron fraction. The larger number of organisms occurs in the smaller fraction. Sample collections shall be made with this in mind.

Routine media should be utilized first for test purposes, but it is obvious that a "complete" analysis for growth of viable organisms can never be obtained on a limited supply of sample. Enrichments of the samples and synthesized media based on a range of non-homogeneous lunar sample properties should also be prepared.

Tests for the presence or absence of organisms in lunar samples can be undertaken which are similar to those utilized for terrestrial desert soils or extraterrestrial materials such as carbonaceous chondrites.\* Tests should be performed to reveal the presence of common as well as

---

\* See section on Control Testing



specialized microflora groups and the ability of these organisms to grow in various culture media. Viable microfauna are extremely unlikely, but, if present, may appear in some of the microbiological tests.

Populations and groups of microbiota are found in soils which vary considerably in their morphology, nutrition, physiology, metabolism or respiration (gas activities). On the basis of their nutrition, energy source, or their physiological mode of existence, microorganisms have been artificially placed or categorized in a number of groups. Some soil microbiota are versatile in their ability to metabolize more than one energy source, or they may prefer one energy source to another when given alternate modes of nutrition. In some cases, more than one energy source may be utilized by the same nutritional group in occupying the same habitat, and such organisms are called "mixotrophes." Nutritional groups are usually studied after their primary isolation in non-selective or broad spectrum growth media; e.g., fluid thioglycollate or an infusion base medium.

Requirements for growth of terrestrial organisms are commonly considered to be the following:

1. Energy source
2. Water at various activity (suction) levels
3. Essential ions
4. Regulatory environmental factors; e.g., pH, Eh, osmotic pressure, barometric pressure,\* radiation, temperature, etc.

---

\* Suggested pressure ranges shall include atmospheric pressures of approximately 0.001 - 100 with intermediate ranges of 0.01, 0.05, 0.1, 0.5, 1, 10, 15, and 31. These are preferred atmospheric conditions which can be correlated with soil grain sizes and moisture availability.

5. Essential "growth factors"; e.g., certain vitamins

The common microflora groups should include the following:

1. Aerobes
2. Microaerophiles (facultatives)
3. Anaerobes
4. Heterotrophs
5. Chemoautotrophs
6. Photoautotrophs

The above groups of microflora can be further categorized as follows:

1. Bacteria (especially bacilli, soil diptheroids, and cocci)
2. Streptomycetes (actinomycetes)
3. Fungi (especially ascomycetous molds)
4. Algae (especially filamentous blue-greens and coccoid greens)
5. Others - myxomycetes, myxobacteria, viruses, and protozoa

"Physiological" groups of the above microorganisms can include at least the following (which overlap, or are composed of the above groups):

1. Heterotrophic microorganisms (bacteria, streptomycetes, yeasts, and fungi capable of growing in various organic enrichment media, including osmophiles--sugar fermenters)
2. Aerobic microorganisms (no reduction of  $O_2$  tension)
3. Microaerophilic microorganisms (partially reduced  $O_2$  tension:  $\pm 13\%$ )
4. Anaerobic microorganisms ( $CO_2$ ,  $N_2$ ,  $H_2$ , Methane or inert gases)
5. Photosynthetic microorganisms (algae and bacteria)
6. Heterotrophic nitrogen fixers
7. Photosynthetic nitrogen fixers

8. Ammonia oxidizers
9. Nitrifiers
10. Denitrifiers
11. Sulfur oxidizers
12. Sulfate reducers
13. Photosynthetic sulfur bacteria
14. Nonphotosynthetic sulfur bacteria
15. Methane producers
16. Hydrogen producers
17. Heterotrophic iron oxidizers
18. Autotrophic iron oxidizers
19. Halophiles (microorganisms capable of growing at various osmotic pressures and water activities)
20. Temperature preferants\* (cryophiles, mesophiles, and thermophiles - also subject to freeze-thaw cycles)
21. Specialized microorganisms growing in soil extracts
22. Coliforms and enterics
23. Pathogens

"Nutritional" groups, based upon maximum growth of organisms in the following varying complexities of media:

1. No preformed growth factors
2. One or more amino acids
3. B vitamin complexes
4. Amino acids, B vitamins, and/or other vitamins

---

\* One should note that there are obligate psychrophilic microorganisms that will not grow or remain viable above 25°C.

5. Yeast extract (which contains some unidentified factors)
6. Soil (or similar geologic material, which can be a selective or nonselective medium, depending on the kind of soil and the methods of extraction and enrichment)
  - a. Soil extract plus various sugars; e.g., glucose, lactose, sucrose, etc.
  - b. Soil extract plus sugars plus yeast extract
  - c. Salt medium (no preformed growth factors)
  - d. Salt medium plus soil extract
  - e. Salt medium plus yeast extract and/or sugars

## SECONDARY CULTURING PROCEDURES

Secondary culturing procedures are important in determining the potential biological hazard of the lunar sample. It is only through the isolation in pure culture and the identification of organisms by selective techniques that a lunar organism can be distinguished from earth contaminants and subsequent pathogenicity determined.

Media and detailed procedures are found in the appendix.

### I. ISOLATION IN PURE CULTURE

If growth results when lunar sample material is plated on the primary isolation media, the organisms shall be obtained in pure culture by the following techniques:

- A. Colonies shall be aseptically picked with a bacteriological needle from plates or removed from broth cultures with a bacteriological loop.
- B. These primary isolates shall be streaked on the same medium and on several related primary or secondary media and incubated accordingly.
- C. These secondary colonies shall be re-isolated, and colonial morphology shall be observed.
- D. These colonies shall be stained by the various staining techniques (see appendix) and checked microscopically for purity, morphological features (color, sheen, shape, etc.) gram stain, flagellation, sporulation, etc.
- E. Samples of the pure cultures shall be treated as follows:
  1. Lyophilized and stored at  $-70^{\circ}\text{C}$  (dry ice chest or appropriate deep freeze)
  2. Refrigerated on slants or stabs at  $4^{\circ}\text{C}$

3. Transferred every several days into fresh media while testing is occurring or if found necessary for maintenance.

## II. IDENTIFICATION

Attempts shall be made to classify the organisms as:

- (1) Contaminants originating from:
  - (a) Humans
  - (b) Soil, water (and general environment)
- (2) Lunar organisms

It is possible that a lunar organism could also be similar to or the same as a terrestrial soil organism. If so, it shall be identified in the course of these procedures. Ultimate pathogenicity is the final criteria for release of the lunar samples regardless of source. The use of DNA determination G-C ratios will also help to identify organisms.

### A. Observations

1. Macroscopic colonial morphology shall be observed, such as:
  - a. Size of colony
  - b. Shape
  - c. Color
  - d. Texture
  - e. Change in coloration of surrounding medium
  - f. Formation of gas or bubbles in deep tubes or anaerobic culture
2. Microscopic
  - a. Colonial characteristics
    - (1) Type of growth, organized or simple
    - (2) Presence of aerial structures (hyphae, stalks)
    - (3) Spores

(4) Fruiting bodies

(5) Buds

b. Cellular characteristics

(1) Degree of differentiation

(2) Shape

(3) Size

(4) Flagellation

(5) Sporulation

(6) Gram (or other differential) stain

(7) Chloroplasts

(8) Nuclear apparatus

(9) Electron microscopy for detailed anatomical characteristics

B. Selective culturing techniques

References to the detailed schema and classification in Bergey's Manual of Determinative Bacteriology and manuals on Soil Bacteriology are found in the appendix.

1. Human contaminants

In evaluating the possibility of human contaminants, the selective media in the protocol on crew and environment microbiology shall be followed.

2. Media for other microbial earth contaminants are listed in the appendix under secondary culture media. These include specialized media for:

a. Chemoautotrophs

b. Photoautotrophs

c. Halophiles

- d. Sulfur utilizers
- e. Temperature preferents

3. Lunar organisms

Organisms not identified positively by the previously described culturing techniques shall be placed into this category for further testing (organisms only capable of growing in a "lunar extract" shall particularly be studied).

C. Serological investigation

The previously described serological techniques for human contaminants and viruses shall be used in testing all isolates.

D. Fluorescent antibody techniques

Fluorescent antibody techniques are also useful in identifying organisms. These have been previously described (see Crew Microbiology and appendix).

E. Phage typing

Phage typing shall also be used (see Crew Microbiology).

F. Animal challenge

Animal challenge with isolated microorganisms shall be attempted only if a lunar organism is suspected; i.e.:

1. Positive identification is lacking.
2. Evidence of unusual morphology or characteristics indicating a unique and new organism.
3. Previous evidence of pathogenicity against animals (isolation from animals which show disease symptoms).
4. Previous evidence of pathogenicity against plants and not positively identified as a terrestrial plant pathogen.
5. In vitro culture should precede exposure of experimental animals



to build up the numbers of possible organisms. This would be necessary since in many cases of known pathogens, the number of organisms required to produce an infection may be high. This is particularly applicable in fish pathogens. Of course the use of culture for replication of organisms will delay the time when actual testing of animals can be done and when quarantine can be lifted.

G. Plant challenge

Organisms finally designated in the category of "lunar organisms" shall also be used to challenge plants in order to determine pathogenicity.

## BACTERIA

### I. INITIAL TREATMENT OF THE SAMPLE

#### A. Sample Preparation

Anaerobic conditions shall be maintained during these procedures. Samples over 4-6 mm which will need processing should be handled in the dry state if possible. Once the sample has been wetted, it has been altered.

##### 1. Crushing

Hand operated mortar and pestle or rockers shall be used instead of mechanical devices. Pulverizing samples lowers the count by one log.

##### 2. Sieving

Friable materials or samples of volcanic-like rocks can also be forced through stainless steel mesh screens.

#### B. Suspension of sample

This step should be delayed until the geochemists have assessed the effects of exposure to  $N_2$ ,  $O_2$ ,  $H_2O$ , etc., on the conventional samples. The resultant Eh and pH should also be determined.

If the lunar sample consists of silt-like material and is suspended in  $H_2O$  or buffered diluent, a high-pressure press might be necessary to push the  $H_2O$  (and organisms) off of the soil particles.\*

Suspensions of larger sized particles can be agitated (vortex mixer preferred to shakers) centrifuged, and processed accordingly.

---

\* see Richards (1954)

Under anaerobic conditions, a portion of the sample, preferably a powder, shall be suspended in three diluting fluids.

1. Aerobic broth

- a. Trypticase-soy
- b. Thioglycollate
- c. Lunar extract or simulated lunar extract

2. Anaerobic broth

- a. An infusion broth
- b. Gall's broth plus cysteine
- c. Lunar extract or simulated lunar extract

C. Concentration

Two ml of a sample suspension shall be filtered through a sterile assembled Millipore filter (see part 3 C).

D. Freeze-Thaw

Several lunar samples shall be exposed to the following freeze-thaw cycles. These shall simulate lunar diurnal freeze-thaw cycles,  $-165^{\circ}\text{C}$  to  $+120^{\circ}\text{C}$ ,  $-75^{\circ}\text{C}$  to  $+75^{\circ}\text{C}$ , and  $-25^{\circ}\text{C}$  to  $+25^{\circ}\text{C}$  at various lunar soil-water activities:<sup>\*</sup>

1. 0% R.H. ( $\cong$  10,000 atmospheres suction)
2. 10% R.H. ( $\cong$  7,500 atmospheres suction)
3. 50% R.H. ( $\cong$  1,000 atmospheres suction)
4. 93% R.H. ( $\cong$  100 atmospheres suction)
5. 98% R.H. ( $\cong$  31 atmospheres suction)

---

\* Atmospheric suction valves can be obtained by the use of positive gas pressure systems, or by use of thin layers of soil enclosed within chambers (i.e. desiccators) subjected to relative humidities obtained by the appropriate salt solution.

6. 99% R.H.\* ( $\approx$  15 atmospheres suction)
7. > 100% R.H. (0.5 atmospheres suction)

## II. MICROSCOPIC EXAMINATION FOR BACTERIA

Direct microscopic observation of the lunar sample for microorganisms shall be used. However, the ratio of any possible microorganisms in the sample to the proportion of sample material would probably be extremely wide. Separation techniques and concentration of sample for microscopic examination would probably require a larger amount of lunar material than is justified for the tests.

### A. Microscopes

1. Light
  - a. Regular
  - b. Phase
  - c. Darkfield
2. Fluorescent and fluorescent combined with darkfield
3. Electron

Stereoscan microscopy has recently proved of value in the microbiological examination of soil particles.

### B. Procedures

1. Wet mount
2. Dry mount
  - a. Gram stain (Hucker's modification)
  - b. Acid-fast stain (Ziehl-Neelsen)
  - c. Spore stain (Wirtz)

References for stains and staining procedures are found in the appendix.

---

\* This is the lower limit for most terrestrial organisms.

### III. PRIMARY CULTURING

Culture techniques for heterotrophic microorganisms should be performed first, followed by tests for specialized autotrophic groups. All tests should be started and performed concurrently under aerobic and anaerobic conditions and atmospheric pressure, except as indicated. Light of sufficient quality and intensity is required for photosynthetic incubations (including algae). Some microorganisms grow and reproduce rapidly following inoculation. Other groups can grow quite slowly, if low in number and the culture conditions are not favorable. Slower growing species may require a minimum of 2 weeks to 30 days to observe growth, and some organisms can take several or more months.

Certain physical, physico-chemical, and chemical tests can be of value for choosing microbiological tests and for synthesizing culture media. These tests can include the following:

1. Mechanical analysis for soil grain size distribution.\*
2. Moisture content and activity values (suction constants).
3. Bulk density and specific gravity.
4. Porosity or total voids.
5. Aggregation state.

---

\* There are three commonly used methods. Two involve dispersion of the soil in an aqueous medium (pipette and hydrometer method) and the third method involves the use of sieves of different mesh sizes for dry materials. One of the best overall references for items 1, 2, 4, 5, and 8 is Richards, 1954 (see appendix).

6. pH (at various moisture levels).
  7. Eh (at various moisture levels) O-R potential is related to pH and to the reduced conditions of the sample.
  8. Electrical conductivity.
  9. Buffer capacity.
  10. Mineralogy (predominate kinds and quantities of minerals as determined by X-Ray diffraction analysis or petrographic examination).
  11. Available ions (especially the "biogenic ions" - chlorides, nitrates, nitrites, phosphates, sulfates, and carbonates).
  12. Elemental chemical abundance (Spectrographic analysis, but also nitrogen, carbon, hydrogen, oxygen, and sulfur).
  13. Detectable organic matter and its characterization.
- A. Direct culturing of sample

A portion of the sample shall be kept under anaerobic conditions during handling, grinding and inoculation and shall be added to the media specifically designated for anaerobic or microaerophilic testing.

If the analyses performed by the geochemists indicate a potential initial harmful reaction between sample/liquid (acid or alkali pH, violent chemical reactions) or sample/gas interfaces, etc., direct plating shall not be done. Instead, attempts shall be made to "neutralize" the samples (by the use of buffers, etc.) or otherwise provide ameliorating conditions.

However, if these analyses do not indicate adverse reactions, the sample can be directly plated on various media.

If the sample size is 2-6 mm the sample shall be directly sprinkled on various media. Larger samples must be reduced in size (see 1-A.). The use of pour plates shall be avoided since some organisms may be killed at the temperature of molten agar.

- (1) Aerobic conditions are those with circulating air and the usual concentration of oxygen (21%  $O_2$ ).
- (2) Microaerophilic conditions can be obtained by adding 13% oxygen to the usual  $N_2+CO_2$  incubator.
- (3) Anaerobic conditions are those in which  $O_2$  is excluded (10%  $CO_2$  90%  $N_2$  or  $H_2$ ).
- (4) In vacuo
- (5) An atmosphere of  $H_2$ , rare gases, or one simulating any lunar "atmosphere" caused by offgassing, etc.

#### 1. Biphasic culturing

This simple technique shall be used in addition to routine liquid and solid culturing listed below. It has been proved to provide optimum growth conditions. A 9-10-fold increase in the total number of organisms has been reported compared to conventional liquid cultures in the same medium.

The system consists of a solid complete medium base with a distilled water overlay. The nutrients slowly diffuse into the liquid menstrum. The toxic end products from the liquid are in turn absorbed by the agar. 0.1 - 1% charcoal or soluble starch can also be added to the agar base if so desired. It has the advantages of providing an initially diluted medium,

a reservoir of slowly released nutrients, and a capability of absorbing toxic products from the medium. A detailed description of this technique will be found in the Appendix.

## 2. Extract enrichment media

The lunar sample shall be inoculated into extract and enrichment media. Soil extract, enrichments of soil extracts, and synthesized salt media shall be used to culture possible organisms from lunar materials. An extract of lunar materials is preferable, but more than one kind of extract would have to be prepared and this could easily exhaust the sample supply. Synthesized media or extracts based on lunar soil composition shall be used to culture microorganisms from lunar materials. Soil extracts and enrichment media:

- a. Selected, 1:1 (or other ratios) soil: water extracts of mixed "typical" agricultural soils and mixed "typical" desert soils.
  - (1) Hot water extract
  - (2) Cold water extract
  - (3) Acid extract, pH adjusted
  - (4) Base extract, pH adjusted
- b. Salt medium - soil extract for photoautotrophs and algae.
- c. Salt medium and enrichment for photoautotrophs and algae.
- d. Lunar soil (cold water) extracts
- e. Lunar soil extract enrichment - to be determined on basis



of lunar soil composition, ion availability, and possible organics.\*

- f. Sintered glass enrichment implantation tubes or capillary enrichment implantation tubes for partial imbedding in lunar soil.

### 3. Sequential exposure culturing

The pulverized sample shall be subjected to a sequential exposure to a wide variety of culture media and incubation conditions. Basically, this might be done in an incubation vessel equipped with membrane filters on the outflow to retain the sample and on the inflow to prevent introduction of organisms. Liquid media could be programmed to flow through the unit at any rate or desired sequence. The incubation temperature could be programmed as desired. The gas flow for agitation and aeration shall be sterile and gas composition ( $O_2$ ,  $N_2$ ,  $CO_2$ ) could be controlled. Growth shall be detected by monitoring for  $CO_2$  if this gas is not used for input. A better system might be to use  $C^{14}$ -labeled nutrients. Another alternative might be to monitor turbidity.

### 4. Radioactive medium ( $C^{14}$ -labeled medium)

The lunar sample shall be inoculated into media containing  $C^{14}$ -labeled substrates and shall be analyzed for  $C^{14}O_2$  during incubation. Many terrestrial microorganisms metabolize organic substrates to yield  $CO_2$ . Production of  $C^{14}O_2$  from labeled substrates would provide an indication of viable organisms in

---

\* This procedure should be deferred unless the organic analyses indicate sufficient organic contents to render the techniques meaningful.

the lunar sample and indicate a similarity of metabolic pathways (Horowitz, 1966). The details of this procedure are found in the Appendix.

5. Organic broth

- a. Fluid thioglycollate\*
- b. Fluid thioglycollate +  $\text{CaCO}_3$ \*
- c. Trypticase or tryptic soy broth\*
- d. Infusion broth
  - (1) Brain-heart
  - (2) Beef-heart
  - (3) Beef-liver\*
  - (4) Veal infusion
- e. Nutrient broth
- f. Lactose broth
- g. Eugonbroth
- h. Tinsdale's broth
- i. Dubos broth base + Tween 80\*
- j. Selenite F broth
- k. Tetrathionate enrichment broth
- l. Todd-Hewitt broth
- m. Leptospira broth\*

6. Inorganic broth\*

- a. Nitrate broth for nitrate reducers (denitrifiers)
- b. Urea broth for ammonification

---

\* Also suggested by the CDC.

- c. Potassium nitrate-glucose solution for denitrifiers
  - d. Czapek-dox broth (inorganic nitrogen metabolizers)
  - e. Beijerinck's thiosulfate solution for thiosulfate oxidizers
  - f. Ferric ammonium-citrate-nitrate solution for heterotrophic iron bacteria.
7. Organic agar
- a. Blood agar\*
    - 5% defibrinated rabbit blood and either trypticase or tryptic soy or Casman's blood agar base.
  - b. Fresh blood agar
  - c. Mac Conkey's agar\*
  - d. Nutrient agar
  - e. Semi-solid brain heart infusion agar (0.5% agar)
  - f. Chocolate blood agar
  - g. Trypticase or tryptic soy agar
  - h. Thornton's agar
  - i. Dubos cellulose decomposition medium (aerobic)
  - j. Lowenstein-Jensen media
  - k. 7-H-10 media
  - l. Egg media (for actinomycetes)
8. Inorganic agar\*
- a. Lunar extract or simulated lunar extract
  - b. Salt medium for photoautotrophs and algae
  - c. Burk's nitrogen-free salt medium for nitrogen-fixers

---

\* Also suggested by the CDC.

- d. Stephensen's media for nitrifiers
    - (1) for Nitrosomonas
    - (2) for Nitrobacter
  - e. Van Delden's sulfate reduction medium
  - f. Starkey's sulfur oxidation medium
  - g. Van Niel's photosynthetic sulfur medium
  - h. Leathen's autotrophic iron oxidation medium
9. Selected media for microaerophilic tests
- a. Fluid thioglycollate
  - b. Fluid thioglycollate +  $\text{CaCO}_3$
  - c. Trypticase-soy agar
  - d. Blood agar
  - e. Thornton's agar
- (It is not necessary to reduce  $\text{O}_2$  tension per se with media a and b)
10. Selected media for anaerobic tests
- A culture of a strict and fastidious anaerobe such as Clostridium haemolyticum shall be included as a monitor for the adequacy of the media and anaerobiosis methods.
- a. Fluid thioglycollate
  - b. Fluid thioglycollate +  $\text{CaCO}_3$
  - c. Blood agar
  - d. Trypticase-soy agar in  $\text{CO}_2$ ,  $\text{N}_2$  and He
  - e. Thornton's agar in  $\text{CO}_2$ ,  $\text{N}_2$  and He
  - f. Anaerobic agar in Brewer covers (jars)
  - g. Anaerobic agar + dextrose in Brewer jars.

- h. Methane fermentation in agar for CO<sub>2</sub> reduction
- i. Hydrogen fermentation agar for CO<sub>2</sub> reduction
- j. Nitrate broth for nitrate reducers and nitrate formation
- k. Winogradsky's glucose-phosphate N-free medium for anaerobic bacteria (anaerobic N-fixation)
- l. Omeliansky's cellulose decomposition medium (anaerobic)
- m. Gall's broth + cysteine

B. Culturing from suspended sample

If necessary, the lunar sample shall be suspended in various diluents to neutralize any initially harmful reactions. Depending on the geochemists' analyses, these shall include buffered diluents, protein enriched broths, beef heart infusion broth, 0.85% saline, etc.

1. Whole suspensions

- a. One ml of suspension shall be inoculated into the broth and agar media listed in section A.
- b. Broth and agar shall be incubated at the designated temperatures aerobically and anaerobically.
- c. Broth and agar plates shall be examined daily until growth occurs. Plates shall be kept at least 60 days.

2. Centrifuged suspensions

These suspensions shall be centrifuged at a low speed.

The resultant supernatant and sediment shall also be used as inocula for the media described in the previous sections.

C. Culturing from sample concentrated by Millipore filtration

After samples have been suitably resuspended (as indicated in the previous section), the organisms in the supernatant shall

be concentrated by Millipore filtration. These samples shall also be observed microscopically. The Millipore filter shall be treated as follows, using MF broth medium, MF yeast and mold medium, MF total count medium, and/or other desired media selected from section A.

1. The filter or pad shall be saturated with broth and incubated under high humidity.
2. The filter shall be placed directly into broth.
3. The filter shall be placed directly on the surface of solid media.

The media shall be incubated aerobically and anaerobically at 27°C and 35°C and other indicated temperatures (i.e. 4, 18, 45, 56). These media shall be monitored for growth as previously indicated.

D. Culturing from sample concentrated by flotation or liquid partition\*

If initial culturing attempts with lunar material are negative, flotation or liquid partition methods shall be used to release and concentrate any organisms adhering to particulate matter.

1. Flotation

Certain flotation fluids, such as Ludox, when combined with a

---

Lundgren et al., 1967

Albertsson, 1960

Advanced Bread Boards for B.W. Detection. Vol. 1, 1966, Space-General Corporation, Defense Documentation Center SGC 952R-3.

shaking-preincubation period ( $\pm$  3 hours) have been found to enhance the transfer of organisms from soil particles into this surrounding liquid menstruum.

## 2. Liquid partition

Certain mixtures of aqueous polymers tend to separate into two liquid phases. Particles in the micron range size (bacteria, viruses, etc.) tend to concentrate in one phase or the other. Systems such as 5% Du Pont 72-60 polyvinyl alcohol + 10% Pharmacia Dextran-250 shall be used.

## IV. SECONDARY CULTURING

The methods are described under Secondary Culturing Procedures, at the beginning of the Lunar Sample Testing section.

## V. REFERENCES

### A. General

Allen, O. N., 1957. "Experiments in Soil Bacteriology, 3rd ed." Burgess Pub. Co., Minneapolis, Minnesota.

Baker, F. J., 1962. "Handbook of Bacteriological Technique." Butterworth and Co., London, England.

Baltimore Biological Laboratory, 1956. "Culture Media, Materials and Apparatus for the Microbiological Laboratory, 4th ed." Baltimore Biological Laboratory, Inc., Baltimore, Maryland.

Black, C. A., Editor-in chief, 1965. "Methods of Soil Analysis. Part 1. Physical and Mineralogical Properties, Including Statistics of Measurement and Sampling." American Society of Agronomy, Inc., Madison, Wisconsin.

Black, C. A., Editor-in-chief, 1965. "Methods of Soil Analysis. Part 2. Chemical and Microbiological Properties." American Society of Agronomy, Inc., Madison, Wisconsin.

Breed, R. S., E. G. D. Murray and N. R. Smith, 1957. "Bergey's Manual of Determinative Bacteriology, 7th ed." The Williams & Wilkins Co., Baltimore, Md.

Chapman, H. D. and P. F. Pratt, 1961. "Methods of Analysis for Soils, Plants and Waters." University of California, Berkeley, California.

Collins, C. H., 1964. "Microbiological Methods." Butterworth and Co., London, England.

Consolidated Laboratories, 1961. "Culture Media and Laboratory Preparations." Consolidated Laboratories, Inc., Chicago Heights, Illinois.

Difco Laboratories, 1953. "Difco Manual of Dehydrated Culture Media and Reagents for Microbiological and Clinical Laboratory Procedures, 9th ed." Difco Laboratories, Inc., Detroit, Michigan.

Farber, L., ed., 1960. "Standard Methods for the Examination of Water and Wastewater, Including Sediments and Sludges, 11th ed." American Public Health Association, Inc., New York, New York.

Jackson, M. L., 1958. "Soil Chemical Analysis." Prentice-Hall, Inc., Englewood Cliffs, New Jersey.

Johnson et al., 1959. Methods for Studying Soil Microflora-Plant Disease Relationships. Burgess Pub. Co., Minneapolis, Minnesota.

Lochhead, A. G., 1940. Qualitative Studies on Soil Microorganisms Canadian J. Research 18: 42-53.

Pochon, J., 1954. "Manuel Technique D'Analyse Microbiologique du Sol." Masson et Cie, eds., Paris, France.

Pramer, D. and E. L. Schmidt, 1964. "Experimental Soil Microbiology." Burgess Pub. Co., Minneapolis, Minnesota.

Richards, L. A., ed., 1954. "Diagnosis and Improvement of Saline and Alkali Soils." U.S. Government Printing Office, Washington, D.C.

#### B. Flotation and Partition Techniques

Advanced Bread Boards for B.W. Detection. Vol. 1, 1966. Space-General Corporation, Defense Documentation Center SGC 952R-3.

Albertsson, P. A., 1960, Partition of Cell Particles and Macromolecules J. Wiley & Sons, New York, New York.

Lundgren, D. A., V. W. Greene and M. J. Grundtnee, 1967, Mars Biological Sample Collection and Processing Study Program. Report # 2703. Appl. Sci. Div. Litton Systems, Inc., St. Paul, Minnesota.



## ALGAE

### I. DIRECT EXAMINATION OF THE LUNAR SAMPLE

#### A. Microscopic examination

1. In the direct examination of soil, the fluorescence of the pigments facilitate the detection of algae. Fluorescence microscopy shall be used to study the lunar sample. The procedures are described in detail in Methods of Soil Analysis, Part 2, 1965.
2. Light and phase microscopes shall be used to examine the lunar material. Supernatants, sediments, and dry material shall be observed.
3. Aliquots of dry material shall be examined by electron microscopy. Preparations of sample and grids are described in the Appendix.

### II. CULTURING

A. The soil-block or enrichment culture method is considered the most useful method in isolating algae from soil.

#### B. Media

1. Media specifically recommended for soil forms are as follows:
  - a. Bristol's solution
  - b. Soil-water medium of Pringsheim
  - c. Willson and Forest enrichment solution
  - d. Wilson's solution
2. Additional media used in the culturing of algae are as follows:
  - a. Cyanophycean agar
  - b. Desmid agar
  - c. Diatom sea-water agar
  - d. Eraschreiber solution
  - e. Euglena medium
  - f. Malt agar

- g. HBB agar
- h. Polytomella medium
- i. Porphyridium agar
- j. Proteose agar
- k. Schreiber's solution
- l. Soil extract agar
- m. Trebouxia agar
- n. Volvocacean agar
- o. Waris solution

### III. OBSERVATION

The following observations shall be made:

- A. Gross morphology
  - 1. Texture
  - 2. Pigmentation
- B. Rate of growth
- C. Microscopic examinations for algal morphology

### IV. REFERENCES

Allan, M.B. and Arnon, D.I., 1955. Studies on nitrogen-fixing blue-green algae: I. Growth and nitrogen fixation by Anabaena cyclinaria Lemm. Plant Physiol. 30: 346-372.

Bristol, B.M., 1920. On the alga-flora of some desiccated English soils: an important factor in soil biology. Ann. Botany 34: 35-79.

Burges, A., 1958. Microorganisms in the soil. Hutchinson & Co., London, Eng.

Evans, D.D., et al., 1965. Methods of soil analysis, Part 2. Chemical and microbiological properties. C.A. Black, Editor in Chief. Amer. Soc. of Agronomy, Inc. Publishers, Madison, Wisconsin.

Pringsheim, E.G., 1946. The biphasic or soil-water culture method for growing algae and flagellata. *J. Ecol.* 33: 193-204.

Starr, R.C., 1964. The culture collection of algae at Indiana University. *Amer. J. Bot.* 51(9): 1013-1044.

Tchan, Y.T., 1959. Study of soil algae. 1. Fluorescence microscopy for the study of soil algae. *Proc. Linnean Soc. H.S. Wales* 77: 265-269.

Willson, D. and Forest, H.S., 1957. An exploratory study on soil algae. *Ecol.* 38: 309-313.

Wilson, J.F., 1937. Pure cultures of algae from soil. *Soil Sci. Soc. Am. Proc.*, 1: 211-212.

## FUNGI AND ACTINOMYCETES

### I. DIRECT EXAMINATION OF LUNAR SAMPLE

#### A. Macroscopic Examination

1. Five mg of untreated sample shall be placed on a microscopic slide.
2. It shall then be examined in the dark with a Wood's lamp for evidence of fluorescence.

#### B. Microscopic Examination \*

1. Light and phase microscopes shall be used to examine lunar material.
2. If fluorescent material is present, it shall be examined microscopically and cultured.
3. Suggested treatment for direct observation.

##### a. 10% Potassium Hydroxide

- (1) Five mg of sample shall be placed in a drop of 10% potassium hydroxide on a glass slide.
- (2) A cover slip shall be added and the slide shall be heated by holding it for a few seconds over a Bunsen burner. Do not boil.
- (3) This slide shall then be examined under the low power of the microscope with reduced light for the presence of fungal elements. It shall also be examined under high power.

##### b. India Ink

- (1) Five mg of sample shall be placed in a drop of India ink on a slide.
- (2) The cover slip shall be added.
- (3) The slide shall be examined under low power and higher magnification if needed.

---

\* Formulas for stains and various procedures are found in the Appendix.

c. Lacto-phenol cotton blue

- (1) Five mg of sample shall be placed in a drop of lacto-phenol cotton blue.
- (2) The sample shall be teased and mixed using a 22 gauge wire needle.
- (3) This shall then be covered with coverslip.
- (4) The slide shall be examined with low power and with higher magnification if necessary.
- (5) If spores or other diagnostic structures are observed, it may be possible to identify the culture solely by direct examination.

II. EXTRACTION, SUSPENSION AND CONCENTRATION OF SAMPLE

The specimen shall be handled according to the procedures listed under the section on Bacteria.

III. PRIMARY CULTURING

The lunar sample shall be cultured aerobically and anaerobically for the presence of fungi, including yeasts and actinomycetes.

A. Media

1. Sabouraud's dextrose agar.
2. Sabouraud's dextrose agar with 1% yeast extract.
3. Brain heart infusion agar ( $\pm$  antibiotics).
4. Sabouraud's dextrose agar with cyclohexamide and chloroamphenicol.
5. Corn meal agar.
6. Potato dextrose agar.
7. Phytone yeast.
8. Actinomyces.
9. Jensen's streptomycete agar.

10. Martin's rose bengal agar
11. Mycophil media
12. Wort agar
13. Czapek-dox agar
14. Sabhi-blood media
15. Malt extract media
16. Basidiomycete media
17. Soil extract agar
18. Natural media (infusion)
19. Beebe's Hay Infusion-dung agar (Myxomycetes, etc.)
20. Raper's Hemp agar for (Achylya)

B. Incubation

The temperatures used for incubation shall be room temperature (25° to 30°C) and 35°C.

C. Lighting

The cultures shall be incubated in light (daylight 10-12 hours per 24 hours) and dark (only) 25°, 35°C.

D. Observation

The following shall be observed:

1. Gross morphology
  - a. Texture
  - b. Pigmentation
2. Rate of growth
3. Microscopic examination for fungal morphology (teased mounts in lacto-phenol blue preparations).

IV. SECONDARY CULTURING

- A. Special media shall be used to induce sporulation or to produce a particular structure or a special type of cultural growth.

1. Sabouraud's dextrose agar
  2. Potato dextrose agar
  3. Corn meal agar
  4. Urea agar
  5. Loeffler's media
  6. Eosin methylene blue
  7. Beef extract blood agar
  8. Carbohydrate broth media
  9. Yeast morphology agar
- B. Nutritional or other physiological tests shall be used to determine the diagnostic physiological characteristics of the isolate. (Page E-16, CDC Mycology Laboratory Manual).
- C. In some instances it may be necessary to perform animal tests to identify fungal pathogens. (Mice and Guinea Pigs).
- D. Slide cultures shall be prepared to determine the relationship of spores to the conidiophores. See Appendix.
- E. More detailed procedures are given in the previous section, entitled Secondary Culturing.

#### V . REFERENCES

See the references listed on page 50 of the Crew Microbiology section and the general references on pages 114-115 of the Attempt To Culture Bacteria From The Lunar Sample section.

## PROTOZOA

### I. SAMPLE PREPARATION

Five gm of the lunar sample shall be suspended in 30 ml of sterile physiological saline. This shall be stirred for 5 minutes and then allowed to settle.

### II. MICROSCOPIC EXAMINATION

A. Direct microscopic examinations of soil are laborious and generally not recommended for terrestrial soils. It is recommended, however, that the lunar sample be examined for the presence of cysts.

1. Several drops of the supernatant shall be examined with light and phase microscopes for the presence of cysts.

Smears shall be made of the supernatant, dried, stained, and examined microscopically.

2. Slides shall be made of the sediment and examined, using light and phase microscopy.

Smears of the sediment shall be dried, stained, and examined microscopically.

### III. Culturing

A. The method devised by Singh for soil protozoa, using a nonnutrient agar carrying a controlled bacterial population, shall be used in the attempt to culture protozoa from the lunar sample. The procedure is described in detail in the Methods of Soil Analysis, Part Two (1965).

B. An additional method using Mannitol Soil Extract agar is described for the isolation of protozoa in soil by Allen in Experiments in Soil Bacteriology (1949).



#### IV. OBSERVATION

The following observations shall be made:

- A. Gross morphology
- B. Rate of growth
- C. Microscopic examination for diagnostic features

#### V. REFERENCE

Alien, O. H., 1949, Experiments in Soil Bacteriology, Burgess Publishing Co., Minneapolis, Minnesota.

Black, C. A., et al., 1965, Methods of Soil Analysis, Part Two, Am. Soc. of Agronomy, Inc., Madison, Wisconsin.

## VIRUSES

The procedures for the isolation of animal, plant, and bacterial viruses from the lunar sample shall be correlated with the other pertinent sections of the protocol

### I. EXTRACTION, SUSPENSION AND CONCENTRATION OF SAMPLE

The procedures listed under Attempts to Culture Bacteria and the Virology sections of crew and environment microbiology shall be followed in preparing the lunar material.

### II. MICROSCOPIC EXAMINATION

Aliquots of dry material from each 1 gm sample will be examined by direct electron microscopy. Preparation of sample and grids are described in the Appendix. In addition, supernatants of samples concentrated by ultracentrifugation shall be observed. Concentration of sediment may also be necessary to provide proper visualization of viruses.

### III PRIMARY AND SECONDARY CULTURING

#### A. Animal and plant viruses

Procedures for inoculation into animals, tissue cultures, etc. are given in the sections on:

1. Viral challenge
2. Animal and plant challenge
3. Crew and environment microbiology

#### B. Bacterial Viruses

Lunar sample supernatants or suspensions shall be added to log phase cultures of representative groups of bacteria growing in various media (depending on the organism). Cultures shall be incubated for

several hours and centrifuged. The supernatants shall then be tested for plaque-forming ability with the same strains of bacteria. Various dilutions of the supernatants shall be added to warm 0.7% agar containing bacteria at a concentration of  $10^8$ /ml. This shall then be poured over a hard agar medium base. After incubation, the plates shall be examined for plaques. If plaques are found, bacteriophage shall be re-isolated and purified.

The following list of bacteria might be used as representative of some of the typical organisms worthwhile testing.

Pseudomonas aeruginosa

Escherichia coli

Azotobacter vinelandii

Bacillus subtilis

Rhizobium leguminosarum

Staphylococcus aureus

Streptococcus lactis

Streptomyces griseus

Lactobacillus casei

Penassay broth and agar shall be used for all organisms except Azotobacter vinelandii which shall be grown on Burk's medium (see appendix).

These experiments shall be coordinated with the procedures in the Plant sections on Challenge of Microorganisms.

#### IV. IDENTIFICATION

Attempts shall be made to identify all viral isolates. Those unidentifiable or thought to be of lunar origin shall be studied in greater detail for potential biological hazard.

##### A. Animal and Plant Viruses

Procedures for the identification of animal and plant viruses have been given in the other pertinent sections of the protocol

including the Appendix.

**B. Bacterial Viruses**

Bacterial viruses can be recognized and classified as to morphology (electron microscopy) and host specificity.

**V. REFERENCES**

Luria, S.E. and J.E. Darnell, Jr., 1967. General Virology, 2nd Ed., J. Wiley and Sons, Inc., New York, Chapters 1 & 2.

Also see the appropriate references in the section on Viral Challenge.

ANIMAL AND PLANT CHALLENGE

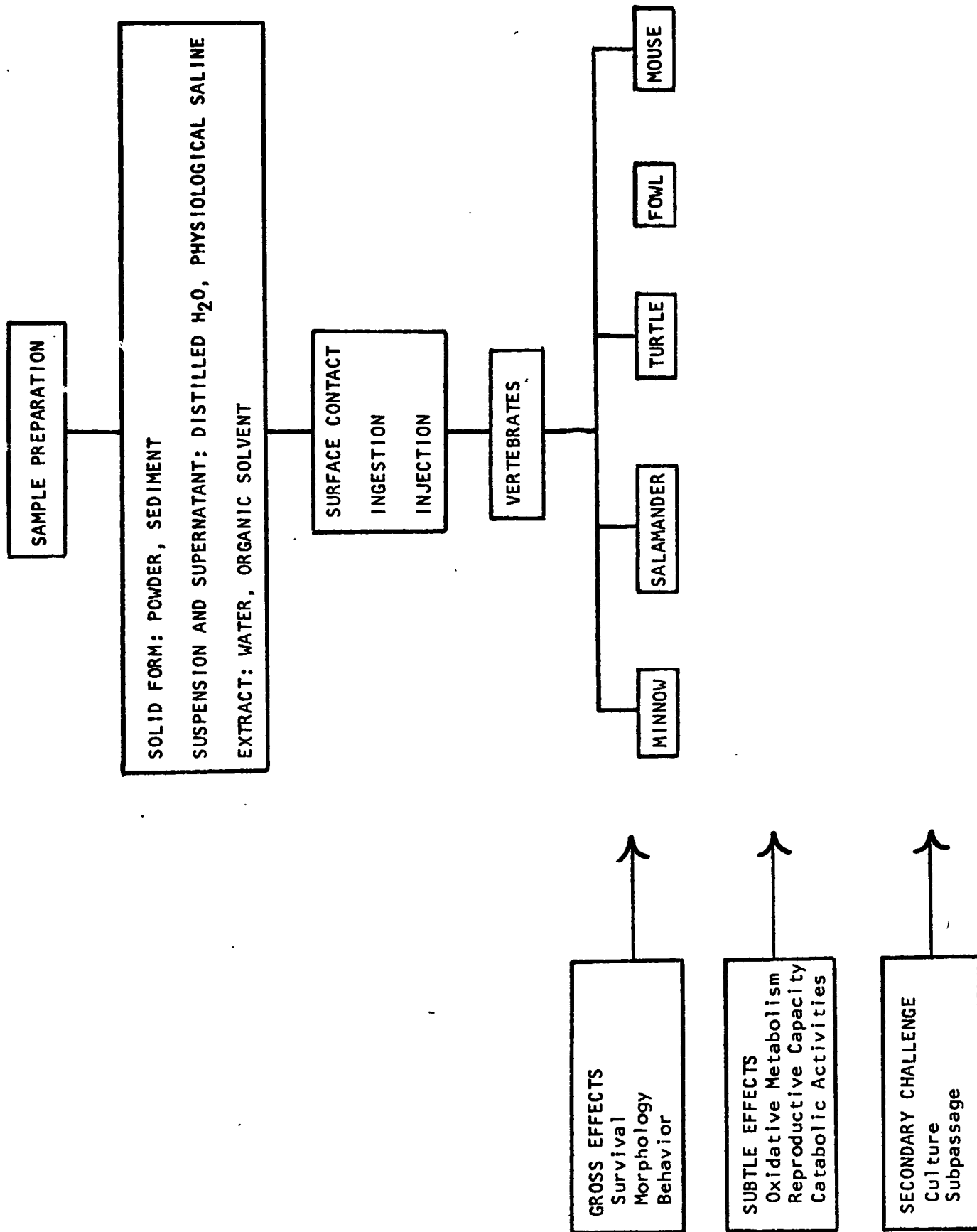

INVERTEBRATE AND PROTOCHORDATE ANIMAL SCHEMA

## PRIORITY TESTING

## Protozoa

## Flagellata

Euglena gracilis

## Rhizopoda

Amoeba proteus

## Ciliata

Paramecium aurelia

## Coelenterata (Cnidaria and Ctenophora)

Pelmatohydra oligactis (hydra)

## Platyhelminthes

Dugesia doroptocephala (planaria)

## Aschelminthes (Nemathelminthes)

Rhabditis maupasi (nematode)

## Annelida

Lumbricus terrestris (earthworm)

## Mollusca

## Gastropoda

Otala lactea (snail)

## Bivalvia

Crassostrea virginica (oyster)

## Echinodermata

Arbacia punctulata (sea urchin)

## Arthropoda

## Crustacea

Daphnia (water flea) or Artemia (brine shrimp)

Insecta

Blatella germanica (cockroach)

Chordata

Cephalochordata

Branchiostoma (amphioxus)



INVERTEBRATE SCHEMA

## ADDITIONAL SPECIES OF HIGH PRIORITY

## Protozoa

Blepharisma undulans (pink protozoa)

## Platyhelminthes

Hymenolepis diminuta (tapeworm)

## Aschelminthes

Epiphanes (rotifer)

## Insecta

## Diptera

Drosophila (fruit fly)

Anopheles quadrimaculatus (mosquito)

## Coleoptera

Tenebrio molitor (mealworm)

VERTEBRATE SCHEMA

## PRIORITY TESTING

## Phylum Chordata

## Vertebrata

## Pisces

Pimephales promelas (fat-head minnow)

## Amphibia

Ambystoma tigrinum (tiger salamander)

## Reptilia

Pseudemys scripta elegans (red-eared turtle)

## Aves

Gallus gallus (domestic fowl)

## Mammalia

Mus musculus (mouse)

VERTEBRATE SCHEMA

## ADDITIONAL SPECIES OF HIGH PRIORITY

## Phylum Chordata

## Vertebrata

## Pisces

## Chondrichthyes

Elasmobranchii - Mustellus canis (smooth dogfish shark)

## Osteichthyes

Salvelinus fontinalis (Brook trout)Oncorhynchus (Pacific salmon)

## Choanichthyes

Protopterus aethiopicus (African lungfish)

## Amphibia

Xenopus laevis (South African clawed toad)

## Reptilia

Anolis carolinensis (American chameleon)

## Aves

Coturnix coturnix (quail)

## Mammalia

Cavia porcellus (guinea pig)

### SPECIES SELECTION

It will be impossible to test biologically the lunar sample on all earth species. Portions of the sample should be tested in representative members of all major taxa. Because of the concept of "unity within diversity" of biological processes on earth, certain selected organisms would provide a broad-based spectrum for biological testing purposes. Whenever possible, selections within a major taxon should be made on the basis of differences in environment, reproductive mechanisms, feeding habits, temperature and salinity tolerances, and other diverse characteristics of the organism.

Selection of species in the protocol has been made with the following parameters in mind:

1. Is the species easily acquired in adequate supply to allow for continuity in the testing procedure should the initial stock or culture be lost? Can the species be maintained in the laboratory without resort to highly specialized equipment and personnel?
2. Is sufficient knowledge of the normal biology of the species available to allow for the formulation of critical testing procedures? Is the species well suited for testing the effect of the lunar sample on a fundamental biological process? Does the test give a more-or-less immediate response, and does it involve a normal aspect of the biology of the species?
3. Does the species represent a group of organisms which are well known to most biological scientists? Where possible, are the species of commercial importance or representative of species of commercial importance?

### CONTROL TESTING

1. The efficacy of the protocol must be pre-tested, using a variety of poisons, antimetabolites, pathogens, and irritants prior to testing biological systems with samples derived extraterrestrially.

Preliminary studies (dry runs) should be performed, using a series of terrestrial soil samples. These samples should also be inoculated with a known concentration of specific pathogens and the recovery values determined.

2. Toxicity tests should await the results of spectrophotometry, since simple inorganics, such as magnesium, copper, and arsenic, are known to be lethal to many lower forms.
3. Investigators should have, at the earliest possible time, the results of the chemical analysis of the lunar material. If compounds known to be deleterious are present in the sample, then a simulated lunar sample should be used as an additional control.
4. Control samples of terrestrial origin shall be similar in composition and physical character to the lunar sample.
5. "Experimental controls" shall be run using autoclaved or sterilized lunar material.
6. Any testing of the lunar material to ascertain deleterious biological effects should be conducted with appropriate control organisms and with statistical treatment of the data collected whenever feasible.
7. The environment of the control animals and plants shall simulate the experimental as closely as possible.

METHODS OF EXPOSURE

The following methods of challenge of biological systems are suggested:

1. Injection of any replicating form cultured from the lunar sample, its products, or derivatives.
2. Injection of products or derivatives from organisms reproducing and growing in growth media enriched with lunar material.
3. Direct challenge of living systems by lunar material:
  - a. (1) Injection of lunar material into organism  
(2) Injection of aqueous, saline, or other extracts of lunar material
  - b. Ingestion of solid particles either from drinking water or from material placed on or into dietary materials peculiar to the test organism.
  - c. Suspension of the lunar sample in medium occupied by aquatic specimens or substrate (culture media, soil). It is recognized that water-soluble materials will undergo considerable dilution.
  - d. Application of the lunar or derived material to skin or other appropriate surface where absorption or entry might take place.

### SAMPLE SIZE USED IN EXPOSURES

Models have been devised to estimate the gram amounts necessary for the detection of microorganisms in the lunar sample. (See the analysis, "Computation on Probabilities of Detecting Microorganisms in Mass of Lunar Sample," given in the Appendix.)

The following factors shall be considered in the translation of models for detecting replicating organisms to an operational protocol:

1. Is the theoretical gram amount chemically toxic to the host organism?
2. Is the environment selected a hospitable one for its survival, growth, and replication? Is the species chosen an adequate "host"?
3. If a suitable environment is found, will its presence in the host be detected? Will a reaction be apparent?

SOLUTIONS

## 1. Lunar Sample

- a. Varying concentrations of the lunar sample shall be used in all tests. Until the chemical composition of the sample is known, the concentrations necessary for testing remain subjective.
- b. Chemical toxicity or the organism's tolerance to inorganic compounds and specific elements will be of prime consideration in establishing concentration levels. "Dry runs" can establish a general level of chemical tolerance. After the inorganic analysis of the lunar sample is available, then concentration levels can be adjusted to these findings. This may involve eliminating those on the upper scale and adding sequentially decreased concentrations on the lower scale.
- c. The lunar sample shall be aseptically added to sterile distilled water, nutrient solutions and media, and physiological saline.
- d. The chemical effect of the lunar sample on the composition of nutrient solutions and salines must be considered. Appropriate controls may have to be established for valid interpretation of the experimental results. Elements or compounds present in the lunar sample may alter the composition of the solutions.

## 3. Extracts of the lunar sample shall be prepared.

## (1) Suggested procedure for sample extraction:

1 gram sample in 10 ml or 9 ml H<sub>2</sub>O

Sequential extraction

Cold water  
Hot  
Alkaline  
Acid  
Organic solvent



50% Methanol  
Methanol  
Methanol-chloroform  
Chloroform-ether, etc.

Filtrates shall be obtained by passage through a graded series of filters (i.e., Millipore).

## 2. Water

### a. Fresh water

Pyrex-glass-distilled water shall be used unless specifically noted.

### b. Salt water

(1) Normal sea water may be used

(2) Commercial preparations are available

Sea salts:

(a) Instant Ocean

(b) Rila Marine Mix  
Utility Chemical Company  
Paterson, New Jersey

## 3. Physiological saline

The composition of approximately 100 physiological salines for invertebrates and vertebrates are given in the following reference. The salines are for use with molluscs, crustacea, insects, annelids, fish, amphibia, reptiles, and mammals.

A.P.M. Lockwood. "Ringer" solutions and some notes on the physiological basis of their ionic composition. *Comp. Biochem. Physiol.*, 1961, Vol. 2, pp. 241-289, Pergamon Press Ltd., London.

## 4. Nutrient solutions and media

Solutions and media referred to are listed in the individual protocols, their references, or in the Appendix.

ANIMAL CHALLENGEGENERAL STATEMENT

Animals shall be exposed to the lunar sample, using the procedures described in the following pages.

1. In all instances, whether specifically cited or not, the first assessment will be to determine if there are any changes in the general condition of the organism, a lack of well being, or death.

If such an alteration occurs, then the cause must be determined.

The change can be due to:

- a. Natural causes not related to sample exposure.
  - b. A chemical reaction to the sample.
  - c. Diseased state caused by a replicating organism within the sample.
2. If such a gross change does not occur, then the assessment shall be made, according to the specific procedure given, to determine what subtle effect, if any, the lunar sample has on the normal biology of the organism in question.
  3. In all tests the experimentals shall be compared to the controls.

GENERAL INSTRUCTIONS

1. Personnel familiar with, and trained in, the maintenance of non-mammalian animals shall be used as attendants, in addition to those for mammalian and invertebrate care.
2. Attendants shall be instructed in the handling of infectious materials.
3. All animals and materials shall be treated as infectious.
4. Animals shall be held and observed for signs of disease. The length of time shall be dependent on the longevity of the specific species.
5. Animals selected shall be healthy and free of obvious anatomical anomalies.
6. Animals shall be kept in an environment as close to the natural one as possible; temperature shall be regulated when necessary.
7. The control animals shall be held in the same volume as the experimentals; i.e., water in aquaria, "cage" space.
8. When experimental animals are exposed to a small volume of water containing the lunar sample, as in finger bowls or beakers, sterile water shall be used.
9. Separate filtering systems shall be used for aquatic forms only when daily sampling of the water in the closed systems indicates an accumulation of metabolic products or saprophytic bacteria to the extent that their presence would harm the test animals.

Filters which chemically detoxify the water or reduce the number of potential pathogens which may be multiplying would affect the results of the tests.
10. Individual species of animals shall be kept in separate units.
11. Control animals shall be kept separate from the test animals.
12. Animals once exposed to the lunar sample shall not be allowed to come in

contact with other species. The lunar sample may cause an animal to liberate a substance that could possibly kill another species if held in the same chamber.

13. Feeding schedules of the controls shall conform to those of test organisms.
14. Control animals shall be subjected to mock test procedures such as tagging and inoculation.
15. Autopsies shall be performed on all dead or sacrificed animals.
16. Carcasses, tissues, and any materials derived from these shall be sealed in plastic bags, preferably then sealed in cans, and finally stored at approximately  $-70^{\circ}\text{C}$  for an indefinite period of time.
17. All material shall be sterilized prior to being disposed of.
18. Statistical methods for small sample groups shall be applied whenever applicable.

### TESTING

All species, following their exposure to the lunar sample, shall be observed (either macroscopically or microscopically) for a period of time. A lethal toxicity of the lunar sample will be immediately obvious. In such an event, the species shall be exposed to graded doses of the lunar sample to determine the LD<sub>50</sub> or some similar criterion of toxicity.

While the major testing procedure for all species shall be simply observing the exposed organisms for signs of toxicity or pathogenicity, more critical tests have been devised in case the lunar sample is not immediately toxic but has either a subtle or no effect. In the following protocol, attention has been given to the details of such tests which would allow for a definite and, in some cases, quantitative statement for subtle effects.

The following general tests may be applied to more species to provide a necessary consistency in the testing procedure from one group of organisms to the next:

1. The effect of the lunar sample on oxidative metabolism
  - a. The rate of O<sub>2</sub> consumption in organisms exposed to the lunar sample shall be compared with the rate in non-exposed controls.
  - b. Standard manometric or polarographic methods shall be used.
  - c. Most species listed are aerobic in their metabolism; however, many invertebrates are facultative anaerobes, and low endogenous rates of metabolism, as monitored by O<sub>2</sub> consumption, may be expected.
  - d. Many substrates which stimulate oxidative metabolism in vertebrate

tissues are without effect in invertebrates. To determine the effect of the lunar sample on oxidative metabolism in the presence of substrate requires that a metabolizable substrate be chosen. This may be determined empirically or, in most cases, may be obtained from the literature for a given species or tissue.

2. The effect of the lunar sample on reproductive capacity

- a. The effect of the lunar sample on the rate of reproduction in those species actually cultured in the laboratory, i.e., protozoans and some nematodes, shall be determined by the rate of increase in cell or individual number, protein/nucleic acid content of population, or dry weight.
- b. The effect of the lunar sample on the reproductive capacity and development of more advanced species shall be determined by exposure of the adults.
- c. This shall be followed by observations on their ability to produce viable eggs which undergo normal subsequent development through the various stages of the life cycle of the species of the adults.

3. The effect of the lunar sample on catabolic activities

Catabolic activity is best monitored by nitrogen balance studies. The effect of the lunar sample on the normal nitrogen excretion of a species can be conveniently determined by standard methods.

ASSESSMENT OF THE EFFECT OF EXPOSURE TO SAMPLE MATERIALS

(Comparisons shall be made with control animals and published values)

1. Survival rate
2. Observations of behavior, increases or decreased activity, unusual physiological signs.
3. Body weight gain or loss at end of experiment, or at autopsy on dead or sacrificed animals. Also organ weights.
4. Examination of appropriate tissue sections on dead or sacrificed animals. Use of general staining reactions for sections of tissues of major organs: liver, intestine, heart, lungs, spleen, kidney, brain, pancreas (difficult to find in some animals).
5. Enzymatic assays on appropriate organs or tissues. Several typical and widely occurring enzymes shall be assayed. Examples: glutamate dehydrogenase (EC 1.4.1.2); glutamate-oxaloacetic transaminase (EC 2.6.1.); and lactic dehydrogenase (EC 1.1.1.27). Methods are readily available for determination of these enzymes. Probably all occur in the liver of all vertebrates.
6. Oxygen consumption of appropriate organs (slices) of animals sacrificed at various intervals during the test period.
7. Blood chemistry: Cell count; concentration of various inorganic ions and organic components of serum or plasma; hemoglobin content of whole blood of the vertebrates (exclude lower chordates); freezing point depression of blood (for determination of osmolarity of blood). This test shall be performed only if the appearance or behavior of the animals is abnormal. Repeated handling of some forms, such as fish, may by itself cause serious damage.

8. Nitrogen analysis of urine and/or feces where possible.
9. Rate of cell division of rapidly dividing cells.
10. Examination of embryonic or larval stages in appropriate experiments.
11. Viability of sperm; ability to fertilize eggs of gravid females.



HISTOLOGY

1. Standard histological techniques shall be employed in the preparation of animal tissue. Some modifications may be necessary with certain species.
  - a. General biological fixatives shall be used.
    - (1) Alcohol-formalin-acetic acid.

AFA is a fast procedure that requires minimal washing.
    - (2) Bouin's fluid  

Requires prolonged rinsing.
    - (3) Zenker's  

Requires prolonged rinsing.
  - b. Standard embedding and sectioning procedures shall be used.
    - (1) Dehydration.
    - (2) Paraffin embedding.
    - (3) Five micron sections shall be made.
  - c. Standard stains shall be used.

Heidenhein's hematoxylin.
2. Both light and electron microscopes shall be used.

## SECONDARY CHALLENGE

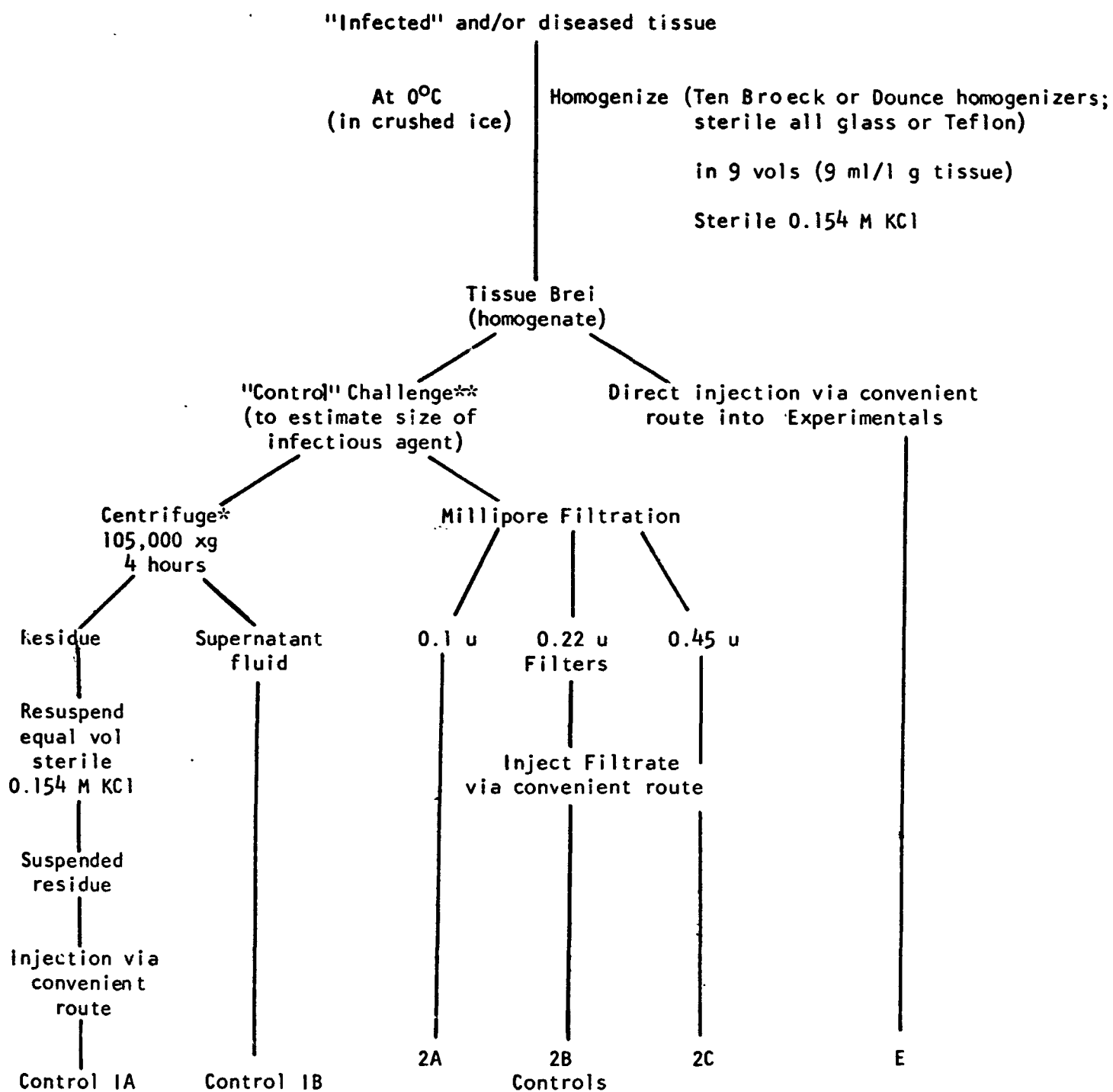

\* Beckman Spinco Model L or L-2 Preparative Centrifuge

\*\* Will allow an estimate of size of "infectious agent"

ATTEMPTS TO CULTURE MICROORGANISMS  
From Previously Exposed Animals or Plants

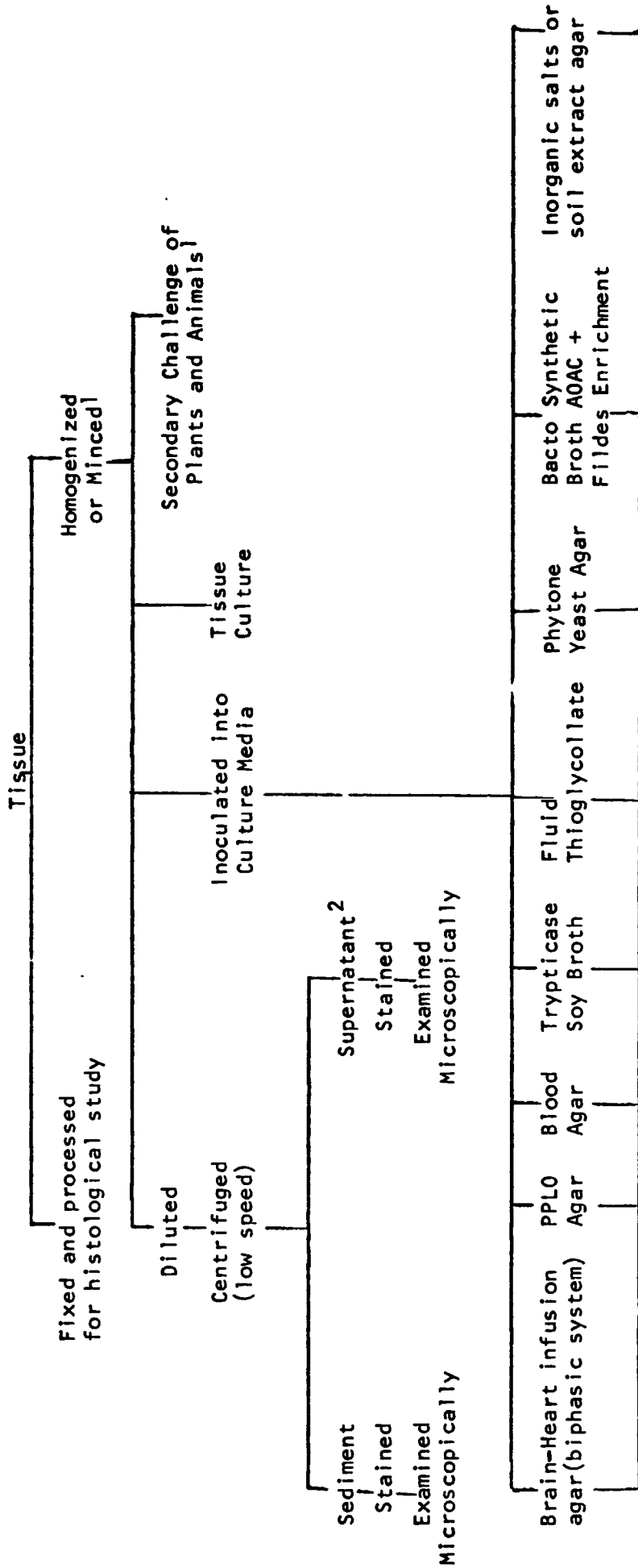

Incubate aerobically and anaerobically at 25° and 35° for 2 weeks. Incubate one set of plates in a 12 hr light-dark cycle.

Isolate in pure culture  
Identify

Repeat animal and plant secondary challenge if necessary<sup>1</sup>

<sup>1</sup> See Secondary Challenge

<sup>2</sup> If large numbers of organisms are present in the supernatant, it shall be used as an inoculum also.

### INVERTEBRATE CHALLENGE

Because of the diversity and number of the invertebrates, it would be impractical to assess the effects of the lunar sample on representatives of each major group.

Both free-living and parasitic forms have been included in the testing procedures. Since most parasitic animals, particularly parasitic helminths, have quite complicated life histories, frequently involving several invertebrate or vertebrate hosts, those species which can be maintained in routine culture without elaborate facilities or apparatus have been selected.

#### 1. Assessment

Various criteria which have been used to evaluate success of in vitro cultivation attempts can also be used as indices against which to measure changes produced by exposure to the lunar sample. Such criteria may be categorized as follows:

- a. Observational, macroscopic
  - (1) Motility and reaction to stimuli
  - (2) Changes in external morphology
  - (3) Increase in size
- b. Observational, microscopic
  - (1) Motility and reaction to stimuli
  - (2) Changes in external and internal morphology
  - (3) Increase in cell size and cell number
  - (4) Organogeny, gametogenesis, increase in mitotic activity
- c. Physiological
  - (1) Gas exchanges
  - (2) Utilization of substrates
  - (3) Chemical criteria of growth of individuals or populations (mass, protein nitrogen)

d. Special

- (1) Oviposition (worms)
- (2) Encystment (protozoans)
- (3) Infectivity
- (4) Changes in virulence
- (5) Mutagenesis

2. Sources

Persons given as sources for species of protozoans (and other forms), while not normally commercial suppliers, have, however, agreed to supply interested investigators and laboratories. See: J. Protozool. 5: 1, 1958, for complete listing of species available and their sources and culture requirements.

VERTEBRATE CHALLENGE

1. The vertebrates include the homeotherms, considered the most highly organized and delicately balanced group of animals. These might prove to be more susceptible to deleterious agents in the lunar sample than the poikiotherms.
2. A 30-day quarantine period may be inadequate to conclude much more than whether the animal lives or dies because of the longer reproductive and life cycles.
3. Growing animals should be weighed daily so that growth curves, in addition to gross weight changes, can be studied. However, with fish such measurements should be taken only when essential in order to eliminate unnecessary handling.
4. Conditions of stress should be imposed on a series of the animals during the testing period. This is recommended in addition to normal maintenance. Temperature extremes and crowding might render the animals more susceptible to pathogenic agents.

PHYLUM PROTOZOA

CLASS FLAGELLATA (MASTIGOPHORA)

ORDER EUGLENOIDINA

Euglena gracilis var. bacillaris

1. Maintenance

a. Culture

(1) Sodium acetate	0.1 gm
(2) Beef extract (Difco)	0.1 gm
(3) Tryptone (Difco)	0.2 gm
(4) Yeast extract (Difco)	0.001 gm
(5) CaCl <sub>2</sub>	0.001 gm
(6) Distilled water	100 ml

Regular culture tubes (test tubes) shall be used.

b. Temperature

Incubate at 18-26°C.

c. Lighting

Moderate illumination is required for light-grown organisms;  
darkness is required for dark-grown organisms.

2. Exposure

a. The lunar sample shall be added to the liquid culture.

b. In case of undue turbidity, extracts of the lunar sample may be required.  
These shall include hot-water extracts and organic solvent extracts,  
depending upon the nature of the lunar sample.

c. Graded doses of the lunar sample shall be used: 1 gram (or equivalent  
amount of extract)/liter, 10 gram/liter, etc.

### 3. Assessment

- a. The ability of dark-grown organisms to re-synthesize chlorophyll following their exposure to the lunar sample shall be studied.

Light-grown Euglena contain chlorophyll and are nutritionally phototrophic. When dark-grown, there is a loss of the chlorophyll, and they become heterotrophic.

Dark-grown organisms re-synthesize chlorophyll when returned to the light. This change is thus freely reversible in normal individuals. Normal values are described in the reference.

- b. The phototrophic response of exposed organisms to localized illumination shall be studied by macroscopic observation of the culture. This test is based on the normal positive phototrophic reaction of light-grown cultures.
- c. The effect of the lunar sample on flagella shall be observed microscopically. A disruption of the normal flagellar movement may be indicative of toxicity of the sample.

### 4. Reference

p. 348 of plant protocol

J. J. Wolken, A. D. Mellon and C. L. Greenblatt. J. Protozool, 2, 89, 1955.

### 5. Source

Culture Collection of Algae, Department of Botany, Indiana University, Bloomington, Indiana.



## CLASS FLAGELLATA (MASTIGOPHORA)

## ORDER DINOFLAGELLATA

Gonyaulax polyedra

Representative of a group of organisms associated with the "red tide" phenomenon; of commercial importance in the fisheries industry.

1. Maintenance

## a. Culture

KNO <sub>3</sub>	0.020 gm
K <sub>2</sub> HPO <sub>4</sub>	0.0035 gm
FeCl <sub>3</sub>	0.00013 gm
MnCl <sub>2</sub>	0.001 gm
Soil extract	2.0 ml
Glass-distilled water	23.0 ml
Sea-water to	100.0 ml
pH	8.2
Autoclave 15 min. at 15 lb. pressure	

## b. Preparation of soil extract:

One kg calcareous garden soil or potting soil shall be added to 1 liter glass-distilled water; steamed for 1 hour; fluid filtered; decanted; and sterilized after 2-3 days.

## c. Temperature

Incubate at 20°C.

## d. Lighting

200 foot candles illumination shall be used for 12 hours of each 24.

2. Exposure

a. The lunar sample shall be added to the liquid culture.

- b. In case of undue turbidity, extracts of the lunar sample may be required. These shall include hot-water extracts and organic solvent extracts, depending upon the nature of the lunar sample.
- c. Graded doses of the lunar sample shall be used: 1 gram (or equivalent amount of extract)/liter, 10 grams/liter, etc.

### 3. Assessment

The bioilluminescence of Gonyaulax shall be studied.

Gonyaulax, in laboratory culture, shows a diurnal rhythm of luminescence which may be monitored with a photomultiplier photometer sensitive to intensities as low as  $10^{-8}$  microwatts/cm<sup>2</sup>.

Because this diurnal rhythm is indicative of the normal biology of this organism, testing shall involve a study of this rhythm in exposed cultures and non-exposed control cultures.

Normal values and detailed conditions are given in the reference.

### 4. Reference

Sweeney, B.M. and J.W. Hastings, J. Cell. Comp. Physiol. 49, 115, 1957.

### 5. Source

Dr. B.M. Sweeney, Scripps Institution of Oceanography, La Jolla, California.

## CLASS FLAGELLATA (MASTIGOPHORA)

## ORDER PROTOMONADIDA

Trypanosoma (Schizotropanum) cruzi

A parasite of man and other animals.

1. Maintenance

## a. Culture media

## (1) Offutt's medium (preferred)

## (a) Materials

Bacto blood-agar base, dehydrated.

Rabbit blood, sterile, defibrinated

Locke's solution, sterile.

## (b) Stock preparation

Prepare Bacto blood-agar base as directed by manufacturer.

Dispense and sterilize in flasks in 200 ml amounts.

Stock can be stored for several months under refrigeration.

## (c) For use

Melt one flask of stock and cool to 45-50°C.

Add aseptically 10-20 ml fresh, sterile, defibrinated blood.

Tube (screw-cap preferred) in 4-5 ml amounts and slant  
(short slant, deep butt preferred).

Add 0.5-1 ml sterile Locke's solution and test for sterility  
at 37°C for 24 hours.

After inoculation, use screw-caps or rubber stoppers to  
impede evaporation.

## (2) NNN Medium (alternate)

## (a) Materials

Bacto-agar

NaCl

Distilled water

Rabbit blood, sterile, defibrinated

N NaOH solution

(b) Stock preparation

In a flask dissolve the Bacto-agar and NaCl in the distilled water by heating.

Neutralize with N NaOH, dispense in flasks in 150 ml amounts, and sterilize at 12 lbs. pressure for 30 minutes.

Stock can be stored for several months under refrigeration.

(c) For use

Melt one flask of stock, then cool it to 50-55°C.

Using sterile technique, add 10 ml defibrinated blood and mix thoroughly.

Add to tubes in 5 ml amounts, and slant to produce a long slant.

When slants are solidified, paraffin the cotton plugs, and refrigerate for 12 hours.

Test for sterility at 37°C for 24 hours before use.

b. Temperature

Cultures shall be maintained at 22-25°C.

c. Illumination

No special conditions are required.

2. Exposure

a. The lunar sample shall be added to the liquid culture.

- b. In case of undue turbidity, extracts of the lunar sample may be required. These shall include hot-water extracts and organic solvent extracts, depending upon the nature of the lunar sample.
- c. Graded doses of the lunar sample shall be used: 1 gram (or equivalent amount of extract)/liter, 10 grams/liter, etc.

3. Assessment

- a. Macroscopic and microscopic observations shall be made of population growth and morphology.
- b. Assay for virulence.

4. References

Novy, F.G. and W.J. McNeal. J. Infectious Diseases, 1, 1-30, 1904.

Nicolle, C. Bull. Soc. Pathol. Exot. 1, 121, 1908.

Offutt, E.P. L. Parasitol., 32 Suppl., 1, 1946.

Silverman, P.H. Advances in Parasitology, 3, 159-222, Academic Press, New York, 1965.

5. Source

Dr. William Balamuth, Department of Zoology, University of California Berkeley, California.

## CLASS FLAGELLATA (MASTIGOPHORA)

## ORDER TRICHOMONADIDA

Trichomonas vaginalis, strain TVC1. Culture media

## a. Honigberg's medium (preferred)

Fluid thioglycollate with 5% normal horse serum.

## b. Johnson-Trussell Medium (alternate)

Ref.: Johnson, G., and R. E. Trussell. Proc. Soc. Exptl. Biol. Med.

54, 245-249, 1943.

Bacto-peptone	32 gm
Bacto-agar	1.6 gm
Cystein HCl	2.4 gm
Maltose	1.6 gm
Difco liver infusion	320 ml
Ringer's solution	960 ml
<u>N</u> NaOH	11-13 ml

2. Exposure

Introduction into fluid medium in appropriate form as for Euglena gracilis.

3. Assessment

## a. Observational

Macroscopic and microscopic observations shall be made of population growth and morphology.

## b. Assay of virulence

Differences in pathogenicity of axenic cultures of Trichomonas vaginalis shall be evaluated quantitatively by comparison of the mean volumes of 5-6 and 12-14 day lesions produced in C57 Bl/6 mice by subcutaneous flank inoculation of  $7.5-9.0 \times 10^5$  parasites in 0.5 ml medium.

## CLASS RHIZOPODA (SARCODINA)

## ORDER LOBOSA

Amoeba proteus1. Maintenance

## a. Culture

Place 1 inch of the following medium in a finger bowl. Add 4 boiled wheat grains and the ciliates Colpidium and/or Paramecium (see culture of ciliates). Transfer monthly.

NaCl	0.080 gm
NaHCO <sub>3</sub>	0.004 gm
KCl	0.004 gm
CaCl <sub>2</sub>	0.004 gm
CaH <sub>4</sub> (PO <sub>4</sub> ) <sub>2</sub> · H <sub>2</sub> O	0.0016 gm
Glass-dist. H <sub>2</sub> O to make	1000.0 ml
pH	7.0-7.4

b. No special temperature or lighting conditions are required.

2. Exposure

a. The lunar sample shall be added to the liquid culture.

b. In case of undue turbidity, extracts of the lunar sample may be required. These shall include hot-water extracts, and organic solvent extracts, depending upon the nature of the lunar sample.

c. Graded doses of the lunar sample shall be used: 1 gram (or equivalent amount of extract)/liter, 10 grams/liter, etc.

3. Assessment

The test on the amoebae exposed to the lunar sample shall be strictly

an observational one. This shall be performed by personnel familiar with the normal behavior of the amoebae, especially the normal formation of pseudopodia and movement due to amoeboid action and protoplasmic streaming.

Normal amoebae, when undisturbed, are rather active and are characterized by numerous food vacuoles containing the ciliates upon which they have fed by phagocytosis. Under adverse conditions, they round up and no pseudopodia are formed.

An immediate rounding up of the amoebae upon exposure to the lunar sample and their subsequent failure to return to normal activity after a few hours may be indicative of toxicity of the lunar sample.

#### 4. References

Allen, R. D. The Cell (Ed. by J. Brachet and A. E. Mirsky), 11, 135-216, Academic Press, New York, 1961.

Kudo, R. R. Protozoology, 5th Ed., Charles C. Thomas, Springfield Illinois, 1966.

#### 5. Source

General Biological Supply House (Turtox), 8200 South Hoyne Ave., Chicago, Illinois 60620.



## CLASS RHIZOPODA (SARCODINA)

## ORDER LOBOSA

Entamoeba invadens, strain IP

A hardy parasitic form.

Pathogenic in reptiles.

1. Maintenance

## a. Culture medium

## (1) Balamuth's Diphasic Medium (BDM)

Preparation: Boil 2 gm Wilson liver concentrate in 80 ml distilled water and filter. Add 6.4 ml of a  $\underline{M}/4$  solution of  $\text{Na}_3\text{PO}_4$  . 12 ml  $\text{H}_2\text{O}$ , and 7.6 ml  $\underline{M}$  potassium phosphate buffer (4.7 parts  $\text{K}_2\text{HPO}_4$ : 0.3 pt.  $\text{KH}_2\text{PO}_4$ ). Bring the volume to 100 ml in a volumetric flask, transfer to a beaker, and add 3 gm Bacto-agar. Heat gently until agar dissolves, then autoclave at 15 lbs for 20 minutes (pH should be ca. 7.2). Tube as 3 ml slants. Overlay with double-strength egg yolk (Balamuth and Sandza, 1944) fortified with 5% horse serum.

## (2) Balamuth's Non-nutrient Salt Solution (BNS)

$\text{NaCl}$	6.0 gm/l
$\text{KCl}$	0.4 gm/l
$\text{CaCl}_2$	0.2 gm/l
$\text{MgSO}_4 \cdot 7 \text{H}_2\text{O}$	0.8 gm/l
$\text{K}_2\text{HPO}_4$ ( $\underline{M}$ )	Adjust ratio to give 10 ml at pH 7.2 (final conc. = 0.01 $\underline{M}$ )
$\text{K}_2\text{HPO}_4$ ( $\underline{M}$ )	
$\text{CO}_2$ gas from cylinder:	Add slowly while shaking (100-150 ml) until ppt. disappears.
Na thioglycollate (fresh $\underline{M}$ solution)	10 ml/l (final conc. = 0.01 $\underline{M}$ )

Petrolatum seal

Final pH ca. 7.0

Solution is filter sterilized. Thioglycollate is added just before use.

b. Temperature

(1) No incubation is necessary for the trophozoite stage.

(2) 30°C is required for encystment.

c. Lighting

No special conditions are required.

2. Exposure

As for Amoeba.

3. Assessment

a. Observational, as with Amoeba.

b. Encystment

"Well-fed" Entamoeba invadens, when transferred to BNS, incubated for 24 hours at 30°C, and then transferred to BDM, produce 85% cysts after 72 hours at 30°C.

An initial inoculum of  $1.5 \times 10^4$  organisms produces  $1.3 \times 10^6$  after 72 hours.

Differences in total population and in % encystment after exposure to the lunar sample shall be measured by hemocytometer counts.

4. Reference

Balamuth, W. Infectious Diseases 88, 230-236, 1951.

Balamuth, W. J. Parasitol. 48, 101-109, 1962.

5. Source

Dr. William Balamuth, Department of Zoology, University of California, Berkeley, California.

## CLASS RHIZOPODA (SARCODINA)

## ORDER LOBOSA

Entamoeba histolytica, Laredo strain

Entamoeba histolytica, DKB, HK-9 or NRS strains.

I. Maintenance

## a. Culture media

## (1) Balamuth's Medium, modified

Preparation: With a blender, mix the yolks of four hard-boiled eggs with 125 ml 0.8% NaCl. Boil mixture for 10 minutes and replace water loss with distilled water. Filter through Buchner funnel, using several layers of Whatman #2 paper. Autoclave filtrate 20 minutes at 15 lbs, re-filter. Add to the filtrate an equal volume of M/15 phosphate buffer, pH 7.5. Tube in 5 ml amounts, autoclave as before, and store under refrigeration. Before introducing amoebae, add a sterile loopful of rice starch.

## (2) Boeck and Drbohlav's Medium

This is a diphasic medium with an egg base and Locke's solution overlay. It is more difficult to prepare than Balamuth's medium, and the reference is given to provide an alternative culture medium. In using either Balamuth's medium or Boeck and Drbohlav's medium, the medium is preconditioned by inoculation with Clostridium perfringens and incubation for 24 hours at 37°C prior to addition of amoebae and rice starch.

It is noted that Entamoeba histolytica is also grown in monoxenic culture with Trypanosoma cruzi, rather than Clostridium.

Diamond (1961) has been able to culture E. histolytica axenically; his work provides another alternative medium.

b. Temperature

Entamoeba histolytica, Laredo strain; 20-25°C required for optimal growth.

Entamoeba histolytica, DKB, HK-9 or NRS strains; 37°C required for optimal growth.

c. Lighting

No special lighting conditions are required.

2. Exposure

a. The lunar sample shall be added to the liquid culture.

b. In case of undue turbidity, extracts of the lunar sample may be required. These shall include hot-water extracts and organic solvent extracts, depending upon the nature of the lunar sample.

c. Graded doses of the lunar sample shall be used: 1 gram (or equivalent amount of extract)/liter, 10 gram/liter, etc.

3. Assessment

Observational as recommended for preceding protozoans.

It is noted that Entamoeba histolytica has not been induced to encyst in monobacterial cultures, as will E. invadens

4. References

Balamuth, W. and J. W. Sandza. Proc. Soc. Exptl. Med. 57, 161, 1944.

Boeck, W. C. and J. Drbohlav. Am. J. Hyg. 5, 371-407, 1925.

Diamond, Science 134, 336, 1961.

5. Source

Dr. William Balamuth, Department of Zoology, University of California, Berkeley, California.

## CLASS CILIATA

## ORDER HOLOTRICHA

Paramecium aurelia1. Maintenance

## a. Culture

In 1000 ml glass-distilled water add 1.5 gm dried lettuce. Add slight excess of  $\text{CaCO}_3$ . Heat to boiling, filter, and tube in 5-10 ml amounts in Pyrex culture tubes. Autoclave 15 min`15 lbs. Cool and inoculate with Aerobacter aerogenes or A. cloacae (available from American Type Culture Collection, Washington, D.C.). Incubate at room temperature for 18 hours. Inoculate with Paramecium.

## b. Temperature

Incubate at 10-25°C.

## c. Lighting

No special conditions are required.

2. Exposure

a. The lunar sample shall be added to the liquid culture.

b. In case of undue turbidity, extracts of the lunar sample may be required. These shall include hot-water extracts, and organic solvent extracts, depending upon the nature of the lunar sample.

c. Graded doses of the lunar sample shall be used: 1 gram (or equivalent amount of extract)/liter, 10 gram/liter, etc.

3. Assessment

a. Observations shall be made on the growth rate and morphology.

b. The ability of the exposed mating types to clump and undergo conjugation

shall be determined. Several generations can be followed after the exposure of the original parents.

When paramecia of mating types of the same variety are mixed, there is an immediate clumping of the organisms followed by conjugation, a normal process in the life cycle of these organisms.

The generation time for the exconjugants is relatively rapid which also should allow several generations to be followed after exposure of the original parents to the lunar sample.

This shall be useful in establishing whether the lunar sample has a subtle effect on the genetic apparatus that is only apparent after several generations.

#### 4. Reference

Sonneborn, T. M. J. Exp. Zool. 113, 87, 1950.

Beale, G. H. The Genetics of Paramecium aurelia, Cambridge University Press, 1954.

#### 5. Source

Dr. T. M. Sonneborn, Department of Zoology, Indiana University  
Bloomington, Indiana.

## CLASS CILIATA

Tetrahymena pyriformis1. Maintenance

## a. Equipment

Cultures shall be grown in test tubes.

## b. Culture

## (1) Proteose peptone

1-2% proteose peptone fortified with liver fraction L (Wilson Laboratories, Chicago, Illinois) shall be used in the following media:

- a) 2% PP, 2% PP plus 0.1% L, and 2% PP plus 0.4% L.
- b) One liter of the final medium shall contain 10 ml of each of the following stock solutions:
  - 1) No. 1: 10 g  $\text{MgSO}_4 \cdot 7\text{H}_2\text{O}$ , 2.5 g  $\text{Fe}(\text{NH}_4)_2(\text{SO}_4)_2 \cdot 6\text{H}_2\text{O}$ , 0.05 g  $\text{MnCl}_2 \cdot 4\text{H}_2\text{O}$  and 0.005 g  $\text{ZnCl}_2$  per liter
  - 2) No. 2: 5 g  $\text{CaCl}_2 \cdot 2\text{H}_2\text{O}$ , 0.5 g  $\text{CuCl}_2 \cdot 2\text{H}_2\text{O}$  and 0.125 g  $\text{FeCl}_3 \cdot 6\text{H}_2\text{O}$  per liter

The PP, L, and salts shall be mixed in the required volume of water, dissolved by heating to 80°C, filtered and distributed to the culture flasks. These shall be stoppered with cotton and then autoclaved at 1.5 atm (≈112°C) for 20 minutes.

- (2) Cultures shall be held in the 5 ml proteose peptone medium or in 100 ml Erlenmeyer flasks, as described by Zeuthen (1965).

## c. Temperature

25-28°C

2. Exposure

A suspension or an extract of the lunar sample shall be added to the medium.

3. Assessment

The effect of the lunar sample on the viability of the cells, their morphology, and growth shall be determined and compared with the controls.

4. Reference

J. Protozoology 5: 1, (1958).

Zeuthen, Eric, ed., 1965, Synchrony in Cell Division and Growth, Interscience, New York, New York.

5. Source

Carolina Biological Supply Company



## CLASS CILIATA

## ORDER SPIROTRICHA

Blepharisma undulans "pink protozoan"

1. Maintenance

## a. Culture

In 1000 ml glass-distilled water add 1.5 gm dried lettuce. Add slight excess of  $\text{CaCO}_3$ . Heat to boiling, filter, and tube in 5-10 ml amounts in Pyrex culture tubes. Autoclave 15 min. 15 lbs. Cool and inoculate with Aerobacter aerogenes or A. cloacae (available from American Type Culture Collection, Washington, D.C.). Incubate at room temperature for 18 hours. Inoculate with Blepharisma undulans

## b. Temperature

The culture shall be maintained at room temperature.

## c. Lighting

Moderate illumination is required for light-grown organisms; darkness is required for dark-grown organisms.

2. Exposure

a. The lunar sample shall be added to the liquid culture.

b. In case of undue turbidity, extracts of the lunar sample may be required. These shall include hot-water extracts, and organic solvent extracts, depending upon the nature of the lunar sample.

c. Graded doses of the lunar sample shall be used: 1 gram (or equivalent amount of extract)/liter, 10 gram/liter, etc.

3. Assessment

a. The ability of the protozoans to develop pigment in the dark and to lose it in the light following their exposure to the lunar sample shall be studied.

- b. Blepharisma is the "pink protozoan," the color being due to a pigment present in dark-grown organisms. This pigment is photodynamic in action, and dark-grown organisms are consequently killed upon exposure to intense illumination.

When light-grown, the pigment is absent or present in traces. The reversible development of this pigment in the dark and its loss in the light may be taken as a normal part of the biology of Blepharisma. This is an observational test and the details are given in the reference.

4. Reference

Giese, A. C. J. Gen. Physiol. 32, 529, 1949.

5. Source

Dr. H. Hirshfield, Department of Biology, New York University,  
Washington Square College, New York 3, N. Y.

**CLASS CILIATA****ORDER TRICHOSTOMATIDA**

Balantidium coli, (1) Lom isolate; (2) Lysenko isolate

A large parasitic form found in the large intestine of man, monkeys, and pigs.

**1. Maintenance****Culture Medium**

Balantidium coli shall be cultured in the same medium used for intestinal amoebae.

'Balamuth's medium, modified' for Entamoeba histolytica.

**2. Exposure**

- a. The lunar sample shall be added to the liquid culture as with preceding protozoans.
- b. Two strains of E. coli shall be exposed to the sample.

**3. Assessment**

- a. Observations shall be made on the growth rate and morphology.  
Particular attention should be devoted to any changes in the character of the cilia, macronucleus, micronucleus, cytopharynx, cytopye, and contractile vacuole.
- b. The effect of the lunar sample on the ability to undergo conjugation in exposed organisms shall be determined. Several generations can be followed after the exposure of the original parents.

**4. Reference**

Kudo, R. R. Protozoology, 1966, 5th ed., C. C. Thomas, Publishers, Springfield, Illinois.

**5. Source**

Lom isolate:

Dr. J. O. Corliss, Department of Zoology, University of Illinois,  
Urbana, Illinois.

Lysenko isolate:

Dr. G. H. Ball, Department of Zoology, University of California,  
Los Angeles, California.

COELENTERATA (PHYLUM CNIDARIA AND PHYLUM CTENOPHORA)

The hydroids, jelly fish, corals, comb jellies, sea anemones .

## CLASS HYDROZOA

## ORDER HYDROIDA

Pelmatohydra oligactis (hydra)1. Maintenance

## a. Culture and feeding

(1) Soln. A.	Disodium ethylenediaminetetraacetate	10 gm
	NaHCO <sub>3</sub>	20 gm
	De-ionized water to	1000 ml
Soln. B.	CaCl <sub>2</sub>	20 gm
	De-ionized water to	1000 ml

To each gal. of de-ionized water, 20 ml of Soln. A. and 20 ml Soln. B. are added.

More specific details for the mass culture of hydra are given in the reference (Loomis 1959).

(2) Hydra are fed freshly hatched Artemia.

A method for hatching Artemia "eggs" is given in the reference (Loomis and Lenhoff, 1956).

## (3) Fingerbowls shall be used.

## b. Temperature

The cultures shall be kept at 18-25°C.

## c. Lighting

No special conditions are required for Pelmatohydra.

## 2. Exposure

- a. The lunar sample shall be added to the liquid culture.
- b. In case of undue turbidity, extracts of the lunar sample may be required. These shall include hot-water extracts and organic solvent extracts, depending upon the nature of the lunar sample.
- c. Graded doses of the lunar sample shall be used: 1 gram (or equivalent amount of extract)/liter, 10 gram/liter, etc.
- d. Hydra may be made to ingest insoluble particles in the lunar sample by adding it in suspension to the culture. Reduced glutathione shall then be added to the culture water (final concentration  $10^{-3}$ - $10^{-4}$  M).

## 3. Assessment

- a. Observations shall be made to determine the survival and continued normal activities, such as feeding.
- b. "Feeding response"

Observations shall be made to determine if a "feeding response" is elicited in organisms following their exposure to the lunar sample.

This response is elicited from normal hydra by the presence of reduced glutathione and apparently other substances.

A hydra, in the absence of glutathione or freshly-killed food (crustaceans), has its mouth closed; and its tentacles are outstretched and relatively motionless. After the addition of glutathione to the culture water, the tentacles writhe and seep inwards towards the mouth. The mouth then opens, and material in the culture fluid may be ingested. This response normally takes place within minutes following the addition of glutathione.

### C. Regeneration

The ability of Pelmatohydra to regenerate surgically removed parts following their exposure to the lunar sample shall be studied.

Hydra are noted for their regenerative capacity. Surgical removal of the tentacles and hypostomal region normally results in the formation of new tentacles within a few days.

### 4. References

- Burnett, A.L., R. Davidson and P. Wiernik. Biol. Bull. 125, 226, 1963.  
Ham, R.G. and R.E. Eakin. J. Exp. Zool. 139, 33, 1958.  
Lenhoff, H.M. and W.F. Loomis (editors). The Biology of Hydra, U. of Miami Press, Coral Gables, Florida, 1961.  
Lenhoff, H.M. and K.F. Zimmerman. Anat. Rec. 134, 559, 1959.  
Loomis, W.F. Ann. N.Y. Acad. Sci. 62, 209, 1955.  
Loomis, W.F. Ann. N.Y. Acad. Sci. 77, 73, 1959.  
Loomis, W.F. and H.M. Lenhoff. J. Exp. Zool. 132, 555, 1956.  
Muscatine, L. and C. Hand. Proc. Nat. Acad. Sci. U.S. 44, 1259, 1958.

### 5. Source

Carolina Biological Supply Co., Burlington, North Carolina and other biological supply houses.

Artemia "eggs" are available from most biological supply companies.

## CLASS ANTHOZOA

## ORDER ACTINIARIA

Metridium senile (Sea anemone)1. Maintenance

## a. Culture and feeding

- (1) Sea anemones shall be maintained in 100% sea water.
- (2) Metridium shall be fed freshly batched Artemia although it is largely a flagellary-mucus feeder.

## b. Temperature

Animals shall be kept at 15-18°C.

## c. Lighting

No special conditions are required.

2. Exposure

They may be tested in the same manner as for hydra.

3. Assessment

- a. The effect on the feeding response to freshly killed food such as Artemia shall be observed.
- b. The response of an anemone tentacle to a cotton swab soaked in clam juice shall be studied. Under normal conditions the anemone will discharge nematocysts into the swab. Certain factors are known to inhibit this response. This test would aid in the determination of the chemical toxicity of the sample.
- c. The ability to regenerate after exposure shall be determined.

4. Source

Supply Department, Marine Biological Laboratory, Woods Hole, Massachusetts 02543.



COELENTERATE TISSUE CULTURE1. Methods

A description for the isolation and maintenance of coelenterate cell lines in tissue culture is given in the reference.

2. Exposure

- a. Cold water, hot water, and organic extracts of the lunar sample shall be incorporated into the tissue culture fluid medium.
- b. The tissue culture shall be inoculated with homogenates or filtrates from previously exposed animals.

3. Assessment

- a. Macroscopic and microscopic observations shall be made to determine the effect of the lunar sample at the tissue level.
- b. Subsequent passages shall be made.

4. Reference

Phillips, J.H., 1961, in the Biology of Hydra (Ed. by H.M. Lenhoff and W.F. Loomis) pp. 245-251. U. of Miami Press, Coral Gables, Florida.

PHYLUM PLATYHELMINTHES

The flatworms: planaria, flukes, tapeworms

CLASS TURBELLARIA

ORDER TRICLADIDA

Dugesia dorotocephala (planaria)

1. Maintenance

a. Equipment

The planaria shall be kept in large finger bowls in 1-2 inches of water.

b. Culture and feeding

(1) Culture

(a) Local tap-water aged 2-3 days, preferably with constant aeration.

(b) Filtered pond water (fresh water).

(2) They shall be fed every 2-3 days or once weekly on beef liver cut into cubes approximately 1 cm square.

The animals shall be allowed to feed for several hours. The remaining liver and organic debris shall be removed and the organisms placed in fresh water.

2. Exposure

The lunar sample or an extract shall be added to the initial culture water.

3. Assessment

a. The effect of the lunar sample on the normal morphology, feeding, and locomotion of the animal shall be determined.

b. Planaria are well known for their ability to regenerate and are used extensively to study this phenomenon. The ability of planaria to regenerate following their exposure to the lunar sample shall be studied.

- (1) The planaria shall be starved for approximately one week prior to surgery.
- (2) They shall be cooled to inactivate them and the "head" removed by cutting just above the mid-body region.
- (3) Care must be taken to make the level of cutting the same in the exposed and control individuals.
- (4) The time for the appearance of new eyespots shall be taken as the rate of regeneration.
- (5) The rate of regeneration in the exposed animals shall be compared to the rate in control individuals for a quantitation of the effect of the lunar sample.

#### 4. Reference

Brøsted, H.V. Biol. Rev. 30, 65, 1955.

#### 5. Source

Carolina Biological Supply Co., Burlington, North Carolina, and other biological supply houses.

## CLASS CESTOIDEA

## ORDER CYCLOPHYLLIDEA

Hymenolepis diminuta (tapeworm).1. Maintenance

## a. Equipment

Dubnoff metabolic shaking incubator.

b. Culture - in vitro

## (1) Schiller's diphasic medium.

The base of this medium is NNN blood-agar (vide supra, "NNN medium" for Trypanosoma cruzi), dispensed in 10 ml quantities in 50 ml Erlenmeyer flasks. The base is overlaid with 10 ml Hank's balanced salt solution, adjusted to pH 7.5. Incubations are performed at 37°C in a Dubnoff metabolic shaking incubator under a gas mixture of 95% N<sub>2</sub>--5% CO<sub>2</sub>. Details of transfers are described in the reference.

(2) The culture method of Berntzen requires a constant flow apparatus, for this reason the simple method of Schiller is preferred.

## c. Temperature

Hymenolepis shall be incubated at 37°C.

2. Exposure

The lunar sample or an extract shall be added to the liquid phase of the culture medium.

3. Assessment

The following observations shall be made on an exposed parasitic form cultured in vitro.

## a. Morphology

- b. Rate of growth
- c. Maturation
- d. Oogenesis; production of viable embryos (motile onchospheres)
- e. Infectivity of embryos when fed to Tribolium; recovery % and normal morphology of cysticercoïds.

#### 4. References

Berntzen, A.K. J. Parasitol. 47, 351-355, 1961.

Berntzen, A.K. J. Parasitol. 48, 786-697, 1962.

Schiller, E.L. J. Parasitol. 51, 516-518, 1965.

Schiller, E.L. Exptl. Parasitol. 8, 427, 1959.

#### 5. Source

Hymenolepis diminuta:

Dr. James W. Campbell, Department of Biology, Rice University,  
Houston, Texas.

ASCHELMINTHES (INCLUDING THE NEMATHELMINTHES)

The rotifers, spiny-headed worms, nematodes

CLASS ROTIFERA

ORDER MONOGONTA

Epiphanes (=Hydatina) senta or other species of rotifers.

1. Maintenance

a. Culture

Filtered pond water (fresh water).

b. Feeding

These animals are ciliary feeders. They feed on minute organic particles that are brought into the mouth by water currents produced by these cilia.

2. Exposure

The lunar sample or an extract shall be added to the culture water.

3. Assessment

The rotifers are the "wheel animals." This name refers to the action of the cilia on the trochal disc which, when in motion, give the appearance of a rotating wheel. This ciliary action represents the normal feeding behavior of these organisms.

a. The effect of the lunar sample on the ciliary movement shall be observed.

b. The rate of the ciliary action of the trochal disc in organisms exposed to the lunar sample shall be compared with that of the controls.

4. Reference

Barnes, R.D. Invertebrate Zoology, W.B. Saunders Co., Philadelphia, pp. 135-145, 1966.

Brown, Jr., F.A. (editor) Selected Invertebrate Types, John Wiley and Sons, N.Y., pp. 221-223, 1950.

5. Source

Carolina Biological Supply Company, Burlington, North Carolina, and other biological supply houses. Several species are available.

## CLASS NEMATODA

## ORDER RHABDITOIDEA

Rhabditis maupasi (nematode)1. Maintenance

## a. Equipment

Petri plates

## b. Culture and feeding

(1) Rhabditis normally occurs as a symbiont in the earthworm. To establish a laboratory culture, place small pieces (5 mm square) of the body wall of an earthworm on a layer of 2% agar in covered petri plates and inoculate with active juveniles from the nephridia or seminal vesicles.

(2) Subculturing shall be done periodically by transferring eggs, juveniles, and adults to fresh agar containing fresh pieces of either earthworm or beef.

## c. Temperature

The incubation shall be below 22°C (18-20°C is preferable).

## d. Lighting

No special conditions are required.

c. Rhabditis may also be obtained from earthworms previously exposed to the lunar sample, as outlined in the experiments for Lumbricus.

2. Exposure

a. The lunar sample in solid form (ground to powder if necessary) shall be sprinkled onto the surface of the agar cultures. The sample will be ingested by the juveniles and adults.



- b. Living eggs shall be teased from the body of a gravid female and then placed in a depression slide containing fresh water and the lunar sample in solid or extract form. Some eggs shall be reserved for staining. The rest shall be transferred to fresh agar plates.
- c. Because the relationship of Rhabditis and the earthworm is a symbiotic one, the infected earthworm host shall be exposed as outlined in the Lumbricus experiments.

### 3. Assessment

- a. Agar cultures of Rhabditis contain all stages of the life cycle of this nematode: the eggs, normally free-living juveniles, and male and female adults. It is possible to test the effect of the lunar sample on all stages of the life cycle simultaneously.

The gross effect of the lunar sample on all stages exposed shall be observed.

Viability of the eggs shall be determined by staining and their ability to take up vital dyes; dead eggs stain readily, viable ones do not.

Both adults and juveniles make characteristic nematode side-to-side thrashing motions of movement.

- b. The effect of the lunar sample on the ability of eggs to undergo development shall be determined.

The entire sequence of development from pronuclear fusion through the 2nd cleavage will normally occur within 2 hrs.

The exposed eggs shall be transferred to fresh agar plates and observed for normal or abnormal development.

Sex ratios in exposed vs. non-exposed controls shall be compared.

- c. The effect of the sample on the symbiotic relationship shall be determined by making the above observations on various stages of the life cycle taken from earthworms exposed to the lunar material.

#### 4. Reference

Scott, A.C. Science 87, 145, 1938.

#### 5. Source

May be isolated from locally collected or commercially supplied earthworms.

To locate, slit the earthworm open by a dorsal longitudinal cut. Encysted juveniles are almost always found embedded in flattened, ovoid, brown bodies lying in the coelomic spaces of the posterior somites. Unencysted juveniles usually occur in the seminal vesicles and coelomic spaces near the nephridia; in heavily "infected" individuals, as many as 12-15 juveniles may be found in a nephridium.

## CLASS NEMATODA

## ORDER RHABDITOIDEA

Turbatrix aceti (the vinegar eel)1. Maintenance

## a. Culture

Inoculate commercial clear apple juice, diluted 1:1 with water, with a dense suspension of eels in vinegar (about 20 ml per liter of diluted apple juice). Pour the inoculated juice into 4 liter containers to a depth of approximately 1 inch. Cover loosely. A dense culture develops in 7-10 days.

## b. Temperature

The culture shall be maintained at ambient (room) temperature.

2. Exposure

The lunar sample shall be introduced into the culture fluid.

3. Assessment

The vinegar eel is a free-living nematode often occurring abundantly in vinegar.

The uniqueness of its metabolism; i.e., its extensive utilization of acetate and apparent lack of a tricarboxylic acid cycle, and its ease of culture make it an ideal nematode species for testing.

The test shall be an observational one and involves comparing the vigorous, thrashing, swimming motions of normal unexposed control organisms with the movements of the organisms exposed to the lunar sample.

4. Source

Carolina Biological Supply Co., Burlington, North Carolina.

## CLASS NEMATODA

## ORDEK RHABDITOIDEA

Neaplectana glaseri

A parasitic form

1. Maintenance

## a. Culture

## (1) Stoll's medium

A mixture of 9 ml veal broth, 1 ml raw rabbit liver extract, and 25 mgm glucose shall be prepared aseptically and adjusted to pH 6.0-6.5.

Each 10 ml of the medium shall be inoculated with 25 infective N. glaseri larvae. The tubes, when shaken in the dark for three weeks at 22.5-24.1°C, yield a 100-fold increase in the nematodes.

(2) Jackson (1962) has been able to culture N. glaseri in a chemically defined medium but the results have yielded less than one-tenth the worms of Stoll's medium.

## b. Temperature

22.5-24.1°C.

## c. Light

The tubes must be kept in the dark.

2. Exposure

A suspension, filtrate, or extract of the lunar sample shall be added to the fluid medium. Graded doses of the lunar sample shall be used, 1 gram (or equivalent amount of extract) per liter, 10 gram/liter, etc.

• 3. Assessment

The following observations shall be made:

- a. Morphology
- b. Growth of individuals and population
- c. Motility
- d. Infectivity toward the host, the grub of the Japanese beetle,  
Popillia japonica.

4. References

Jackson, G.J. Exptl. Parasitol. 11,25-32, 1962.

Stoll, N.R. J. Parasitol. 39,422-444, 1953a.

Stoll, N.R. Ann. N.Y. Acad. Sci. 77,126-136, 1959.

Stoll, N.R. Thaper Commemoration Volume, Lucknow, pp. 259-268, 1953b.

5. Source

Dr. William Trager, The Rockefeller Institute, New York, New York.

PHYLUM ANNELIDA

The earthworms, leeches, marine polychaetes

CLASS OLIGOCHAETA

ORDER OPISTHOPORA

Lumbricus terrestris (earthworm)

1. Maintenance

a. Equipment

Terraria

b. Culture

(1) Media

- (a) The earthworms shall be kept in terraria filled to about 12 inches with equal parts of old leaves and leaf loam collected from a wooded area. No additional food is required.
- (b) The recommended medium for breeding is: 1 part dung, 3 parts soil, 5 parts peat moss (adjust to pH 7 using hydrated lime), and a small amount of sand. (Barrett, 1949).
- (c) If necessary, soil can be used alone. It shall be light and sandy without lumps or rocks.

The soil should never be heat sterilized.

Soil cultures tend to dry out more rapidly than those containing more organic material.

- (d) Additional food such as corn meal or chicken mash may be added to the culture. This is not recommended for the quarantine laboratory. Overfeeding or addition of fresh food leads to fungal growth and spoiled cultures.

- (2) The material shall be air dried for several days prior to use to

eliminate possible parasites. It should be remoistened until it contains about 30% water.

The material in the terraria shall be kept moist but not wet.

(3) The substrate shall be kept at pH 7. If acid, hydrated lime shall be worked in to give a neutral pH.

(4) Every two weeks the materials shall be turned to aerate the culture.

c. **Temperature and Lighting**

No special conditions are required.

When rapid breeding is desired, the temperature may be elevated.

2. **Exposure**

a. **Ingestion**

The lunar sample shall be mixed with the dead leaf material and should be normally ingested by the earthworms.

b. **Injection**

(1) The lunar sample shall be injected (as suspension or extract) intra-coelomically into the adult.

(2) The sample shall be injected into the cocoons.

(3) Extracts of the lunar sample shall also be injected in small amounts directly into the blood system via the large dorsal blood vessel.

3. **Assessment**

a. **Adults**

Observations shall be made to determine the survival and continued normal activities, such as negative phototropism and feeding, following exposure to the lunar sample.

b. **Development**

The cocoons of Lumbricus terrestris have several eggs; normally, only one of these develops. The effect of the lunar sample on the

normal development of the egg exposed in the cocoon shall be determined. Extended observations and a comparison of the hatching rate of injected cocoons with that for non-injected ones shall be made.

c. Regeneration

Considerable portions of the body may be regenerated by annelids following injury or loss. Either the anterior or posterior end of Lumbricus will be regenerated providing the nervous system (especially the ventral nerve chord) is left intact.

The ability of exposed animals to regenerate lost segments shall be studied.

The number of segments that can be reformed is limited and is usually less than the number removed; this, however, can be compared in exposed and non-exposed individuals.

4. Reference

The UFAW Handbook on the Care and Management of Laboratory Animals, 3rd Ed., The Williams and Wilkins Company, 1967.

Barrett, T.J., Harnessing the Earthworm. London; Faber, 1949.

Laverack, M.S. The Physiology of Earthworms, MacMillan Co., New York, 1963.

Lutz, F.E., et al. Culture Methods for Invertebrate Animals. Dover Publications, Inc., New York, New York, 1959.

5. Source

General Biological Supply House (Turtox).



## CLASS POLYCHAETA

## ORDER ERRANTIA

Nereis (=Neanthes) virens (marine worm)

1. Maintenance

## a. Equipment

## (1) Aquaria

The aquaria shall be provided with a bottom layer of sand in which the worms may construct burrows.

## (2) Fingerbowls

## 3) Glass tubing

## b. Culture

The animals may be maintained in the laboratory in 100 percent sea water for several weeks if kept at a low temperature.

## c. Feeding

This marine worm is a raptorial feeder, capturing its prey by means of an eversible proboscis. The prey is normally various small invertebrates.

## d. Temperature

10-15°C

2. Exposure

a. By direct addition of the lunar sample to the sea water.

b. By injection of suspension (or extract) of the lunar sample into the coelom.

3. Assessment

a. An observational test shall be performed to determine the effects of the lunar sample on the respiratory movements of Nereis.

b. The worms shall be removed from their tubes in the holding aquaria

and placed in fresh sea water in finger bowls.

- c. A glass tube of a bore slightly greater than the diameter of the worms shall be placed in the finger bowl. The worms will enter these glass tubes.
- d. A carmine suspension shall be added to the water.
- e. The respiratory movements of water through the tube shall be observed.
- f. The effect of the lunar sample on these movements shall be determined.

#### 4. Reference

Brown, Jr., F.A., in Selected Invertebrate Types, (Ed. by F.A. Brown, Jr.), pp. 271-279. John Wiley and Sons, New York, 1950.

#### 5. Source

Supply Department, Marine Biological Laboratory, Woods Hole, Mass, 02543.

## PHYLUM MOLLUSCA

The chitons, snails, slugs, clams, oysters, sea hares, octopi

## CLASS AMPHINEURA

The most primitive molluscs

Chaetopleura apiculata (Common Eastern Chiton) or

Mopalia sp. (West Coast Chiton)

1. Maintenance

## a. Equipment

(1) Aerated marine aquaria

(2) Finger bowls

## b. Feeding

The animals do not require special feeding; they are filter feeders.

## c. Handling

Both species may be maintained for several months in well-aerated marine aquaria.

They should not be crowded.

2. Exposure

a. The lunar sample shall be added to the sea water

b. A suspension, filtrate, or extract of the lunar sample shall be injected into body fluids and cavities.

3. Assessment

a. Observations on the survival and continued normal activity of the chitons following their exposure to the lunar sample shall be made.

In some species, the 'righting time' may be used as an index: organisms which are not normal are slow in, or incapable of, righting themselves after being placed on their backs.

b. During the breeding season of Chaetopleura (June 25-September 25), the effect of the lunar sample on the fertilization and subsequent development

of the eggs shall be determined. To obtain eggs and sperm, place chitons (25-30) in a large container of running sea water and hold for one day. In the evening, decrease the volume of the container to one-half (it is sufficient that the chitons are just covered) and allow to stand overnight undisturbed. The males will extrude sperm into the water and this is followed by spawning of the females in one-half to one hour. After spawning is completed (1st-3rd night), the eggs shall be transferred to fresh sea-water in fingerbowls. They should be washed several times by decantation during the next 24 hours. The normal fertilized egg will develop into a free-swimming trochophore larva within 24-48 hours.

The rate of hatching as well as the survival of the trochophore larvae in the presence of the lunar sample shall be used as a critical test for the effect of the lunar sample on the development of the chiton.

#### 4. Source

Chaetopleura, a small chiton, is available from Supply Department, Marine Biological Laboratory, Woods Hole, Mass. 02543.

Mopalia, a medium sized species, is available from Pacific Bio-Marine Supply Co., P.O. Box 285, Venice, California 90293.

## CLASS GASTROPODA

SUBCLASS PROSOBRANCHIA (fresh-water, marine, and terrestrial snails)

## ORDER NEOGASTROPODA

Thais haemastoma (marine snail)1. Maintenance

## a. Equipment

- (1) Marine aquaria
- (2) Aerator
- (3) Prior to establishing the aquaria, the sea water shall be filtered free of debris.
- (4) Constant aeration is desirable.

## b. Feeding

The sea-water shall be from the area where the species were collected.

No special feeding is required. The aquatic snails are filter feeders.

2. Exposure

The lunar sample shall be added to the sea water.

3. Assessment

The prosobranch molluscs shall be observed for signs of abnormal activity following exposure to the lunar sample. Abnormal activity will be manifest in failure of locomotor activities, withdrawal into the shell, etc.

4. Source

The Houston Gulf Coastal Area is rich in molluscan species, and representatives of several orders of gastropods and bivalves may be collected locally in adequate supply and with sufficient seasonal continuity to sustain the most elaborate testing program. These species may be supplied locally.

Supply Department, Marine Biological Laboratory, Woods Hole, Mass.

## SUBCLASS OPISTHOBRANCHIA

## ORDER TECTIBRANCHIA

Aplysia sp. (sea hare)1. Maintenance

## a. Equipment

- (1) Aerated deep marine aquarium.
- (2) Circulating sea-water system.

## b. Feeding

Aplysia may be kept for several months in deep marine aquaria which are well aerated.

2. Exposure

As for prosobranchs.

3. Assessment

Observations shall be made of the snails' activities.

Normal locomotion of Aplysia is very characteristic with synchronous parapodial movements.

The effect of the lunar sample on these movements shall be determined and compared with the controls.

4. Reference

Morton, J.E., in Physiology of Mollusca (Ed. by K.M. Wilbur and C.M. Yonge), vol. 1, pp. 383-423, Academic Press, N.Y., 1964.

5. Source

Locally supplied.

## SUBCLASS PULMONATA (air-breathing snails)

## ORDER STYLOMMATOPHORA

Otala lactea1. Maintenance

## a. Equipment

Glass aquaria or large fingerbowls

## b. Feeding

The animals shall be fed on lettuce

## c. Handling

These snails, when purchased, are in a state of estivation.

They may be maintained in the laboratory in this state until used.

For arousal, the epiphragm shall be mechanically removed and the snails placed, aperture down, on moist filter paper in a glass aquarium containing fresh lettuce. They will become active and start feeding within a few minutes to a few hours.

2. Exposure

a. A suspension or extract of the lunar sample shall be injected into soft parts of body.

b. The lunar sample shall be topically applied to the foot sole.

3. Assessment

a. The foot sole is heavily ciliated, and normal locomotion is via the action of these cilia.

The effect of the lunar sample on this ciliary action shall be determined.

b. Observation on the survival and continued normal activities of the snails following their exposure to the lunar sample shall be made.

- (1) Normal actively feeding snails undergo a daily cycle of activity which involves nocturnal feeding followed by a period of "inactivity" (which is apparently different from estivation) during the day. During this period of "inactivity," the snails become attached to the vessel in which they are contained by a mucous secretion around the aperture. Since this cycle is part of the normal biology of this species, the effect of the lunar sample on all parts of the cycle, especially the secretion of the "mucous veil," shall be determined.
- (2) The effect of the lunar sample on the long-term cyclic fluctuations in weight shall be determined.

Because of the constancy in this hydration-dehydration phenomenon, the effect of the lunar sample on it may be determined by weighing exposed snails several times daily over a period of a few weeks.

- (3) *Otala* and other helioid land snails are normally negatively geotropic: when they are allowed to creep or crawl on a vertical surface, they move upwards. The effect of the lunar sample on this orientation shall be determined.
- (4) The effect of the sample on the pedal locomotory waves shall be determined. These can be observed as the animal crawls on the glass wall of the aquarium.

#### 4. References

Crozier, W. J. *J. Gen. Physiol.* 18, 659, 1935.

Hunter, W. R. in *Physiology of Mollusca* (Ed. by K.M. Wilbur and C. M. Yonge), Vol. 1, pp. 83-126, Academic Press, N.Y., 1964.

Wells, G.P. and N. Howes *J. Exp. Biol.* 11, 327, 1934; *J. Exp. Biol.* 11, 344, 1934; *J. Exp. Biol.* 20, 79, 1944.



5. Source

Dr. James W. Campbell, Department of Biology, Rice University,  
Houston, Texas 77001

Scozzaro Imported and Domestic Groceries, Store no. 40, Brooklyn  
Terminal Market, Brooklyn 12, New York.

## SUBCLASS PULMONATA

## ORDER STYLOMMATOPHORA

Limax flavus (slug)1. Maintenance

## a. Equipment

Terrarium

## b. Feeding

Slugs shall be fed on lettuce

## c. Handling

Slugs shall be housed in terraria containing sterilized lettuce or leaves remoistened with sterile distilled H<sub>2</sub>O.

2. Exposure

a. A suspension or extract of the lunar sample shall be injected into soft parts of the body.

b. The lunar sample shall be topically applied to the foot sole.

3. Assessment

a. Observational tests on the survival and continued normal activities of the slugs following their exposure to the lunar sample shall be made.

b. The foot sole is heavily ciliated, and normal locomotion is via the action of these cilia.

The effect of the lunar sample on this ciliary action shall be determined.

4. Source

Locally available.

## CLASS BIVALVIA

## SUBCLASS PROTOBRANCHIA

Crassostrea virginica [the oyster (brackish-water)]

## SUBCLASS LAMELLIBRANCHIA

Spisula solidissima (marine clam)

1. Maintenance

## a. Equipment

- (1) Shallow aquaria with sand or gravel.
- (2) Aerator.

## b. Feeding

Animals do not require special feeding; are filter feeders.

## c. Handling

Bivalves shall be maintained in very-well-aerated, shallow aquaria with a bottom layer of sand or gravel.

2. Exposure

The lunar sample shall be added to the water.

3. Assessment

- a. One immediate sign of abnormality in bivalves is a gaping shell, caused by relaxation of the adductor muscles. This may be used as an immediate indicator of lunar sample toxicity following its addition to the water in which the bivalves are kept.
- b. Normally, undisturbed bivalves have their shells slightly open, and, in some, the siphons are protruding to allow for the passage of water currents over the gills in the mantle cavity. The gills are heavily ciliated; and small particles, upon which the bivalves feed, are taken from the water by the action of ciliary tracts and delivered to the mouth. These water currents may be readily observed by the addition of suspended materials to the water.

The effect of the lunar sample on the ability of these molluscs to maintain these feeding/respiratory currents shall be determined.

- c. Quantitation of the rate of these movements, and consequently the effects of the lunar sample thereupon, shall be carried out as follows:

Commercially available graphite suspensions shall be used. These include "Prodag" (5-15 microns in diameter) and "Aquadag" (1-2.5 microns).

These colloidal graphite preparations shall be made up fresh for each test in a concentration of 2-5 mg per liter of bathing fluid.

The optical density of these preparations shall be determined.

The solution shall be divided among several containers into which the bivalves are placed. Each vessel shall be stirred constantly and aerated.

The rate at which water passes through the filtering apparatus of the bivalve shall be calculated from the reduction in concentration of the suspended material, measured as decrease in optical density.

The absolute concentration shall be determined from standard curves prepared with known amounts of the graphite suspension. On the assumption that filtration is 100% efficient in particle retention, the amount of water ( $x$ ) pumped in time ( $t$ ) shall be calculated from the following equation:

$$P_t = P_0 \exp - \frac{x}{M} t$$

where  $M$  = volume of water in vessel

$P_0$  = concentration of graphite at 0 time

$P_t$  = concentration of graphite at time  $t$

These rates shall be compared in organisms exposed to the lunar sample and the controls.

d. Ciliary action

Ciliary action on the gills of bivalve molluscs has universally been used as a criterion for testing the effects of different environmental and physiological factors on these organisms. This shall be used as a critical test for the toxicity of the lunar sample.

The shell from one side of the bivalve shall be removed to expose the mantle covering the gills. This shall be cut away and, with the gills exposed and bathed with the surrounding fluid, powered carmine or graphite shall be added to the water just above the gill. The movement of the suspended particles in the ciliary tracts on the gills shall be observed before and after exposure to the lunar sample.

e. Fertilization and development

Observation shall be made of the rate of development and of morphology.

(1) Crassostrea virginica

To obtain naturally fertilized eggs, ripe females shall be kept out of water for several hours. They shall then be placed in a glass tank in water maintained at 25-27°C. As soon as the shells open, 1 ml of a sperm suspension made by macerating 0.5 gm testis in 50 ml sea water shall be added. Spawning begins in approximately 30 minutes. As soon as sufficient eggs are collected, the females shall be removed from the container.

Fertilization takes place immediately and the eggs settle to the bottom. An approximate timetable for development of the eggs is as follows:

0 time	fertilization
30 minutes	polar bodies
5 hours	free-swimming stage

(2) Spisula solidissima

To obtain eggs, the hinge of the shell shall be removed, breaking the ovary and forcing the eggs to be extruded into a beaker of sea water. The eggs shall be washed by decantation 3-4 times, leaving the heavier, more mature eggs on the bottom of the beaker. Two to three drops of a sperm suspension (one drop dry sperm in 10 ml sea water) shall be added to the eggs contained in 40-50 ml sea water. Dry ovaries and testes may be kept overnight at 4°C; washed eggs should be fertilized within 6 hours.

The fertilized eggs shall be divided in half: to one batch is added the lunar sample and the other serves as the non-exposed control. The timetable for normal development of the fertilized eggs at 25°C is as follows:

0 time	fertilization
30 minutes	polar bodies formed
60 minutes	first cleavage
90 minutes	second cleavage
5 hours	swimming blastula
4-9 hours	gastrula
18-19 hours	young veliger larva

#### 4. References

Allen, R.D. Biol. Bull. 105,312, 1953.

Atkin, D. Quart. J. Micr. Sci. 79,181, 1936.

Jørgensen, C.B. Biol. Rev. 30,391, 1955.

Jørgensen, C.B. J. Mar Biol. Assoc. U.K. 28,333, 1949.

#### 5. Sources

Locally supplied.

Commercial graphite suspensions:

Acheson Colloids Corporation

Port Huron, Michigan

## CLASS CEPHALOPODA

## ORDER OCTOPODA

Octopus bimaculatus1. Maintenance

## a. Equipment

- (1) Salt water aquaria
- (2) Circulating sea-water system
- (3) Aerator and filters

## b. Feeding

The octopus shall be fed every 2-3 days on live crabs.

## c. Handling

The octopus requires a circulating sea-water system which shall be continually aerated and filtered.

They may be kept indefinitely.

2. Exposure

- a. By addition of lunar sample to water.
- b. By injection of suspension or extract of lunar sample into circulatory system.

3. Assessment

The octopus is among the most highly organized of the invertebrates with organs so highly differentiated that it approaches the level of organization of the vertebrates. Because of this, the effect of the lunar sample on the following shall be determined:

"Emotion," general reflexes, and visual acuity.

4. References

Harrison, F.M. and A.W. Martin. J. Exp. Biol. 42, 71, 1965.



Johansen, K. and A.W. Martin. *Comp. Biochem. Physiol.* 5, 161, 1962.

Wells, M.J. *Physiology of Mollusca* (Ed. by K.M. Wilbur and C.M. Yonge),  
Vol. 11, Academic Press, New York, in press, 1966.

Charles, G.H. Ibid.

5. Source

Pacific Bio-Marine Supply Company, P.O. Box 285, Venice, California,  
90293.

Octopus vulgaris obtainable in the Gulf of Mexico.

## MOLLUSCAN TISSUE CULTURE

## GASTROPOD TISSUE CULTURE

1. Methods

A method for the in vitro culture of several tissues from Helix pomatia, Australorlus glabrotus, and Potmatopsis lapidaria is described in detail by Burch and Cuadros (1965).

2. Exposure

A suspension or extract of the lunar sample shall be added to the tissue culture medium.

3. Assessment

Macroscopic and microscopic observations shall be made to determine the effect of the lunar sample on Gastropod tissue cultures.

4. Reference

Burch, J.B. and C. Cuadros, 1965, Nature 206: 637.

5. Source

Cell lines available from:

Dr. J.B. Burch  
Museum and Department of Zoology  
University of Michigan  
Ann Arbor, Michigan 48106

PHYLUM BRACHIOPODA

Lingula (lamp shell)

A marine form dating back to the Ordovician period.

1. Maintenance

a. Equipment

(1) The animals shall be held in marine aquaria.

(2) A circulating sea-water system shall be used.

b. Feeding

No special feeding is required; they are filter feeders.

c. Temperature

15°C.

2. Exposure

The lunar sample shall be added to the fluid medium.

3. Assessment

a. Observations shall be made of any behavioral or morphological changes.

b. Feeding and respiratory currents will be observed in detail as described for the molluscs.

4. References

Barnes, R.D. Invertebrate Zoology. W.B. Saunders Co., Philadelphia, 1963.

Paine, R.T. Ecol. Monogr., 33, 187-213, 1963.

5. Source

Marine Biological Laboratories, Woods Hole, Mass.

## PHYLUM ECHINODERMATA

## CLASS ASTEROIDEA

## ORDER FORCIPULATA

Asterias forbesi or A. vulgaris (starfish)

1. Maintenance

## a. Equipment

- (1) Salt-water aquarium
- (2) Circulating sea-water system
- (3) Aerator

## b. Starfish feed on marine bivalves

## c. Temperature

8-12°C

## d. Handling

Echinoderms shall be kept in a cold, well-aerated, circulating sea-water system.

2. Exposure

- a. The lunar sample shall be added to the sea water in solid or extract form.
- b. The lunar sample or an extract shall be directly injected into the coelomic (perivisceral) cavity.
- c. The sample shall be injected into the water vascular system.

3. Assessment

The general responses of starfish following their exposure to the lunar sample shall be determined.

The following aspects of the biology of these organisms shall be tested:

- a. Locomotion and righting reflex
- b. Reaction to touch
- c. Reaction to light

d. Ciliary action

- (1) The ciliary currents on the aboral surface may be charted with carmine or colloidal graphite. The effect of the lunar sample on the action of these cilia shall be used as a critical test for the toxicity of the lunar sample to the starfish.
- (2) The coelom or perivisceral space of the starfish is lined with ciliated epithelial cells, and these may also be used in the test for the effect of the lunar sample on echinoderm ciliary action.

e. Coelomic fluid

- (1) The protein content of the coelomic fluid has been found to be an extremely sensitive indicator of the physiological condition of some echinoderms, increasing dramatically when they are under stress. The effect of the lunar sample on the coelomic fluid protein levels is therefore a critical test that shall be performed on the starfish.
- (2) The coelomic fluid, when withdrawn from the tips of the arms of Asterias, contains numerous coelomocytes. Since these are specialized cells, the effect of the lunar sample on the movement phagocytic ability of these cells shall be determined. The lunar sample shall be added directly to the fluid for this test.
- (3) The coelomic fluid clots in vitro. The effect of the lunar sample on the clotting time of this fluid shall be determined.

f. Fertilization and development

The animals shall be rinsed first in tap water and then in sea water. The tip of one arm shall be cut along the aboral surface toward the central disc to expose the plume-like gonads. Only if a large portion of the arm is filled with the gonads is the individual

usable. Males have whitish to pale yellow gonads; females, orange.

The ovaries shall be removed from a gravid female and suspended in a double layer of cheesecloth over a fingerbowl containing sea water. The eggs will be shed into the water. After sufficient eggs have been collected, the cheesecloth shall be removed.

About 200 eggs shall be removed with a pipette and added to 50 ml sea water. They shall be washed by decantation.

One drop of a dilute suspension of sperm (prepared by macerating one testis in 25-50 ml sea water) shall be added. The sperm-containing water shall be agitated and after five minutes decanted and replaced with fresh sea water.

Divide the fertilized eggs in half:

One group shall be exposed to the lunar sample (either before or after fertilization) and the other shall serve as the control group.

The normal timetable for development is as follows:

0	time	fertilization
1	hour	polar bodies
2-3	hours	first cleavage
3	hours	second cleavage
7-10	hours	blastula
18-20	hours	gastrula
24-30	hours	bipinnaria larva

4. References

Booolootian, R.A. and A.C. Giese J. Exp. Zool. 140, 207, 1959.

Booolootian, R. A. Amer. Zool. 2, 275, 1962.

Reid, W. M. in Selected Invertebrate Types (Ed. by F.A. Brown, Jr.),  
pp. 515-523, John Wiley and Sons, New York, 1950.

5. Source

Supply Department, Marine Biological Laboratories, Woods Hole,  
Mass.

## CLASS ECHINOIDEA

## ORDER STIRODONTA

Arbacia punctulata (sea urchin)1. Maintenance

## a. Equipment

- 1) Salt-water aquarium
- 2) Circulating sea-water system
- 3) Aerator

## b. Temperature

8-12°C

## c. Handling

Echinoderms shall be kept in a cold, well aerated, circulating sea-water system.

2. Exposure

- a. The lunar sample shall be added to the sea water in solid or extract form.
- b. The lunar sample or an extract shall be directly injected into the coelomic (perivisceral) cavity.
- c. The sample shall be injected into the water vascular system.

3. Assessment

- a. Observational tests shall be made on the survival and continued normal activities of animals following exposure to the lunar sample.

Normally, there is constant movement of the spines and pedicellaria on the surface of sea urchins. Observations on the effect of the lunar sample on the activity of these structures shall be made.

- b. The protein content of the coelomic fluid is an extremely sensitive indicator of the physiological condition of Arbacia, increasing dramatically when they are under stress. The effect of the lunar sample on



the coelomic fluid protein levels shall be determined.

c. Fertilization and development

- (1) A specimen shall be placed aboral-surface-down in a watch glass and 0.5-2.0 ml of 0.5 M KCl injected into the perivisceral coelom through the peristomial membrane with a hypodermic syringe. The ripe sex cells are extruded into the dish through the genital pores.
- (2) The eggs are fertilized with sperm in a manner similar to that described for Asterias; since polyspermy does not normally occur with most sea urchin eggs, the concentration of the sperm is not critical.
- (3) The time table for normal development of the sea urchins is as follows:

	<u>Arbacia</u>
Fertilization	0 time
Polar bodies	--
1st cleavage	1 hr
2nd cleavage	1-1 1/2 hr
Blastula	6-10 hr
Gastrula	20 hr
Pluteus larva	48 hr

The rate of development and morphology shall be observed.

4. Reference

Hyman, L.H. The Invertebrates: Echinodermata, Vol. IV. McGraw-Hill Book Company, Inc., New York, 1955.

5. Source

Supply Department, Marine Biological Laboratories, Woods Hole, Mass.  
Pacific Bio-Marine Supply Co., P.O. 285, Venice, Calif. 90293

## CLASS OPHIUROIDEA

## ORDER OPHIURAE

Ophioderma brevispina (brittle stars)1. Maintenance

As described for Asterias.

2. Exposure

As described for Asterias.

3. Assessment

a. The tube feet (prominent in Asterias and other starfish) are called tentacles in Ophioderma and are sensory in function. They are capable of passing food particles to the mouth.

(1) Food shall be offered to elicit the feeding response.

(2) These feeding movements shall be used to observe the effect of the lunar sample on Ophioderma.

b. Four of the arms are well-coordinated for rapid movement. The effect of the lunar sample on locomotion in Ophioderma shall be determined.

c. The effect of the lunar sample on coelomic fluid protein levels shall be determined and compared to the controls.

4. References

Lutz, F.E., et al. Culture Methods for Invertebrate Animals. Dover Publications, Inc., New York, 1959.

Hyman, L.H. The Invertebrates: Echinodermata, Vol. IV, McGraw-Hill Book Co., Inc., N.Y., 1965.

5. Source

Supply Department, Marine Biological Laboratories, Woods Hole, Mass.

## CLASS HOLOTHUROIDEA

## ORDER DENDROCHIROTA

Thyone briareus (sea cucumbers)1. Maintenance

## a. Equipment

- (1) Salt-water aquarium
- (2) Circulating sea-water system
- (3) Aerator

## b. Temperature

8-12°C

## c. Handling

Echinoderms shall be kept in a cold, well-aerated, circulating sea-water system.

2. Exposure

- a. The lunar sample shall be added to the sea-water in solid or extract form.
- b. The lunar sample or an extract shall be directly injected into the coelomic (perivisceral) cavity.
- c. The sample shall be injected into the water vascular system.

3. Assessment

Respiration is affected in the sea cucumber by rhythmic closing and opening of the cloacal aperture. The rate of this is proportional to the oxygen content of the water and is a good indicator mechanism for the physiological state of the organism. The effect of the lunar sample on these rhythmic respiratory movements shall be determined.

4. Reference

Newell, R. C. and W. A. M. Courtney, J. Exp. Biol. 42, 45-57, 1965.

5. Source

As for Asterias.

PHYLUM ARTHROPODA

## CLASS CRUSTACEA

## SUBCLASS BRANCHIOPODA

## ORDER ANOSTRACA

Artemia salina (brine shrimp)

## 1. Maintenance

## a. Equipment

Artemia shall be kept in battery jars or aquaria.

## b. Rearing

- (1) Eggs shall be hatched in 5-8% NaCl that is kept well aerated.
- (2) The newly hatched nauplii will transform into adults in approximate by 2 weeks.
- (3) The first batch of eggs produced by the females usually go at once to the nauplii stage in the brood pouch and then escape. Subsequent batches of eggs from the same female are resting eggs and must be dried before hatching.
- (4) Under favorable conditions, a generation takes about 3 weeks.

## c. Feeding

The eggs hatch as nauplii larvae and do not require food for four days. An algal growth shall be allowed to develop for food. If this does not occur, a small amount of yeast suspension shall be added as food.

An axenic culture may also be established.

## d. Lighting

Constant illumination is required initially to encourage an algal growth. After the culture is established, a normal light-dark cycle shall be maintained.

## e. Temperature

No special conditions are required.

## 2. Exposure

- a. A suspension or extract of the sample shall be added to a battery jar containing Artemia eggs and sea water.
- b. Varying concentrations of the lunar sample shall be added to a reproducing culture.

## 3. Assessment

- a. A comparison of percent hatching shall be made with exposed and control eggs.
- b. The growth and development of exposed eggs and larvae shall be observed. The effect of the exposure on the transformation of the larvae to the adult shall be determined.
- c. The effect of various concentrations on the reproductive capacity shall be observed.
- d. The activity and behavior of the exposed adults shall be observed.

An orientation test using a single light source shall be performed to test for subtle effects of the lunar sample. Commonly the adults show a 'ventral light response'; i.e., the ventral surface is directed toward a light source. Normal animals show this response as soon as the compound eyes develop. They do not need to be sexually mature adults.

- e. Artemia can survive in concentrated salt solutions only with the continued optimal production and expenditure of energy. Stress, as lunar sample toxicity, will manifest itself almost immediately in death.

Both the larvae (Nauplii) and adult forms rely on the same basic mechanism for osmoregulating in their hyperosmotic surroundings.

It is therefore only necessary to expose the organisms to the lunar sample to determine its effect on a basic osmoregulatory process, that of  $\text{Na}^+$  extrusion.

### 3. Reference

A method of axenic culture is given by:

Provalasi, L. and Shiraishi, Biol. Bull. 117, 347-355, 1959.

Graenkel, G.S., and D.L. Gunn, "The Orientation of Animals," Oxford, 1940,  
(also reprinted by Dover, N.Y., 1961), Chapter X.

### 4. Source

General Biological Supply House (Turtox), Chicago, Illinois.

Carolina Biological Supply Co., Burlington, North Carolina.

## SUBCLASS BRANCHIOPODA

## ORDER DIPLOSTRACA

## SUBORDER CLADOCERA

Daphnia pulex (water flea)1. Maintenance

## a. Culture

Daphnia shall be held in battery jars or aquaria.

They shall be cultured in fresh water in which uni-cellular algae are allowed to grow.

Methods for the culture of Daphnia are described by W. A. Chipman, 1934, and Lutz, et al., 1959.

## b. Feeding

A thick suspension of yeast shall be added to the medium if the algal growth is insufficient. Traditionally, an algal growth is allowed to develop in a pond-water culture.

## c. Lighting

A daily light source is required if algae is to be used as food.

## d. Temperature

No special conditons are required.

2. Exposure

A suspension or an extract of the lunar sample in varying concentrations shall be added to the media.

3. Assessment

- a. The activity and behavior of the animals shall be observed.
- b. Comparison of the survival rates of animals exposed to varying concentrations of the sample and the controls shall be made.
- c. The presence of hemoglobin shall serve as an indication of general health.

Daphnia produces hemoglobin, especially under conditions of low O<sub>2</sub> tension, and loses it under conditions of high O<sub>2</sub> tension. The pigment is produced in sufficient quantities to make the animals appear red and permit visual recognition of this presence or absence.

Animals exposed to the lunar sample shall be subjected to conditions of low O<sub>2</sub> tension. Any interference with the normal synthesis of hemoglobin should be visually detected and compared with the controls.

#### 4. Reference

Chipman, Jr., W.A. Science 79, 59, 1934.

Culture Methods for invertebrate Animals, Lutz et al., Comstock Publ. Co., 1937. (Reprinted by Dover, 1959).

Hemoglobin test: Fox, H.M. and E.A. Phear, Proc. Roy. Soc., 141: 179-189, 1953.

#### 5. Source

Turttox General Biological Supply House, Chicago, Illinois.

Carolina Biological Supply Co., Burlington, North Carolina.



## CLASS CRUSTACEA

## ORDER DECAPODA

Cambarus (Crayfish)

A number of species occur in various parts of the country. The species used will depend upon the source of supply.

1. Maintenance

## a. Size

Small crayfish shall be used (3").

## b. Equipment

(1) Aquaria, preferably with a circulating fresh-water system.

If a closed system is used, the water should be changed weekly.

(2) Eyestackless animals shall be kept in individual containers.

The water shall be changed every 3-4 days.

## c. Feeding

(1) Crayfish may be held in a laboratory for periods up to a month without feeding.

(2) The diet is dependent on the species; crayfish are generally carnivorous.

## d. Temperature

(1) Crayfish shall be maintained at room temperature in a circulating system.

(2) In a closed system, the temperature shall be 20°C.

2. Exposure

A suspension or an extract of the lunar sample shall be added to the water medium.

### 3. Assessment

- a. The survival and morphology of exposed animals shall be observed.
- b. The frequency of molting of exposed eyestalkless animals shall be determined and compared with the controls. Crustaceans are more vulnerable at the actual time of molting (ecdysis) than during any other phase of the molt cycle. Molting frequency is increased by eyestalk removal because this operation removes the x-organ-sinus gland complex and consequently is a molt-inhibiting factor.

### 4. Reference

Passano, L.M., 1960, Physiology of Crustacea, Vol. 1, Chapter 15, Academic Press.

### 5. Source

Carolina Biological Supply Company

## CLASS INSECTA

The Insecta are by far the largest class of invertebrates, both in number of species (700,000, or about 80 percent of the invertebrate species) and in abundance of individuals. Because of the size of this class of animals, it is practically impossible to assay the lunar sample on representatives of each of the 26 orders of insects and of their many families.

A few key species have been selected as test organisms, with the following criteria in mind:

1. The species or genus must have been the subject of extensive studies involving various disciplines (e.g., anatomy, histology, ultrastructure, physiology).
2. The few species selected must be representative of a variety of environments (e.g., aquatic, terrestrial) and represent as well certain main types of metabolism (e.g., saprophagous, phytophagous, hepatophagous).
3. Artificial media should be available for the large-scale colonization or maintenance of uniform batches of test insects (through one complete stage, through one generation, or through many generations). In some cases, gnotobiotic as well as axenic culture methods are known and have been listed. In such cases, the only break of gnotobiotic conditions would be the introduction of the lunar sample into the culture vessel.
4. The species should be available in the United States, and its suppliers should have it in continuous stock culture.

There are certain interstate (Federal Plant Pest Act of May 23, 1957) and intrastate regulations concerning shipment of insects. Authorization to transport insects across state and county lines should be requested. Such permits are obtained from each State Bureau of Plant Quarantine, from the U.S.

Department of Agriculture, and from the U.S. Public Health Service.

In view of the complexity of some rearing procedures or of some diet formulations, it is suggested that a reprint of each paper mentioned in this protocol be obtained, or a copy be prepared on microfilm or microcards, to be stored permanently in the library of the Lunar Sample Receiving Laboratory, as a ready source of information.

If quantal bioassay is required ( $ED_{50}$  or  $LD_{50}$  determinations), computer programs shall be used for the estimation of the median dose and of the slope. The Durachta-Schenk program for the IBM 1401, based on Berkson's logit chi square method (Durachta et al., 1965) is in use at the Corvallis Forestry Sciences Laboratory. Another program is available at the University of Kansas.

In case of positive response after exposure to the lunar sample, the structural or biochemical lesions could be easily and simultaneously interpreted by a number of specialists throughout the country. The diagnosis will be facilitated if the testing laboratory will follow a careful diagnostic procedure as the one outlined by Steinhaus and Marsh (1962). A set of data sheets has been reproduced in their paper and has been in use for various years in Dr. Steinhaus' laboratory.

#### References

- Durachta, C.W., C.E. Schenk, R.G. Dick, and F.M. Sturtevant. 1965.  
Bact. Reviews 29: 560-576.
- Steinhaus, E.A. and G.A. Marsh. *Hilgardia* (University of California)  
33: 349-490, 1962.

## GENERAL TESTING

1. Proper control batches shall be maintained under identical experimental conditions to those of the experimentals exposed to the lunar sample.
2. Sterility tests shall be performed at regular intervals in work involving axenic cultures.
3. Inocula shall be delivered by means of a microinjector.  
(AGLA micrometer syringe, Burroughs Wellcome and Co., Inc., Tuckahoe, New York)
4. Standard 0.25 ml tuberculin syringes, individually calibrated and inserted in the AGLA micrometer shall be used.
5. Steel needles, gauge 30, shall be used for intrahemocoelic injections.  
(BD Yale, Luer-Lok, 1 inch, regular point)
6. The integument shall be disinfected with a solution of Hyamine 10 X (Rohm and Haas Company), 0.4 percent aqueous.
7. Peroral inoculations shall be performed by means of glass microcatheters inserted in Tuohy adapters (Martignoni, 1955, 1959).
3. All inoculations shall be performed after the insects have been anesthetized with ether or with carbon dioxide. If the insect should move during the injection procedure, damage may be inflicted to internal organs; the mid-gut may be ruptured.

References:

- Martignoni, M. E., 1955, Science 122: 764.  
Martignoni, M. E., 1959, J. Insect Pathol. 1: 294-296.

## GENERAL EVALUATION PROCEDURES

The effects of the lunar sample on insects should be evaluated according to the following criteria:

1. The survival rate

This is the ratio of the number of insects at completion of the test to the initial number of insects. The survival rate must be determined for both the test group and the control group. If no differences are found between test and control, the following are determined:

2. The mean growth rate

This can be determined by measuring lengths or weights of insects at established intervals during the testing period. The test and control growth rate shall be compared.

3. The maturation time

This is the time required to complete the larval stage, from the beginning of the test to final metamorphosis (to the adult stage).

4. The maturation rate

This is the ratio of adults appearing in the test group to the initial number of insects. Test and control maturation rate shall be compared. Of course, this can be determined only if the larval diet is adequate for the complete development to the adult stage. This value is comparable, but not identical to the survival rate.

5. The fertility of the adults

6. The reproductive indices

These can be determined in order to detect subtle and chronic effects of the lunar sample.

The determination of the survival rate shall be adequate for the evaluation of the "acute toxicity" of the lunar sample. The determination of the growth rate and of the maturation time will serve to detect less drastic, but equally important effects of the lunar sample.

## CLASS INSECTA

## ORDER ORTHOPTERA

## FAMILY BLATTIDAE

Blattella germanica (Linnaeus), (German cockroach)

The availability of two physiological types of the same species (normal and aposymbiotic) may prove of advantage for the detection of subtle effects of the lunar sample on the host. The aposymbiotic animal can be considered a "weak" variant.

## 1. Maintenance

## a. Equipment

Colonies shall be reared in large glass jars or in the Tolworth system. In this system colonies are kept in larvae cages 40 cm high and 20 cm in diameter with perforated metal lids, plastic sides, and metal bases.

## b. Feeding

(1) Water shall be available at all times in cotton-stoppered vials.

(2) Two diets are recommended:

(a) Oligidic medium (Brooks modification of Haskins formula).

9 lb rolled oats

9 lb "toppings" or whole wheat or Red Dog (bran feed)

1 lb fish meal

1 lb yeast, dried

1 lb corn oil (or 2 cups)

The oats are first pulverized in a Waring blender. After all the ingredients are mixed, the diet is stored in a freezer in a tightly stoppered jar.



For aposymbiotic animals the following diet shall be used:

4 parts of the above mixture

1 part of yeast

0.1% Aureomycin-HCl (Lederle)

b) Holidic medium

A modified Noland diet, with cyanocobalamine (Gordon, 1959). Improved formulations may be available directly from Dr. H. T. Gordon.

c. Temperature

The preferred temperature is 30°C.

A minimum of 27.7°C is required for breeding. Cockroaches can be maintained at 24-25°C without difficulty.

d. Handling

A long pair of fine forceps shall be used to pick up an individual, holding it in the middle of the abdomen.

Carbon dioxide, chilling, or a combination of both shall be used to subdue a large number of animals.

Chloroform vapor is lethal to cockroaches.

2. Exposure

a. Measured amounts of the lunar sample shall be added to the rearing containers.

b. The lunar sample shall be incorporated into the diet.

c. A suspension, filtrate, or extract of the lunar sample shall be inoculated into the hemocoel of cockroaches.

3. Assessment

a. The effects of the lunar sample shall be evaluated according to the following criteria:

Survival rate

Mean growth rate

Maturation time

Maturation rate

Fertility of the adults

The reproductive indices

- b. Molting frequency shall be by the use of Testor's "Dope" yellow paint to mark shed cuticles (Brooks 1965).

#### 4. References

Brooks, M.A., 1965. Ent. Expt. et Appl. 8: 39-48.

Gordon, H.T., 1959. Annals N.Y. Acad. Sci. 77(2): 290-351.

The UFAW Handbook on the Care and Management of Laboratory Animals, 3rd Ed., 1967, Williams and Wilkins, Baltimore.

#### 5. Source

Insects reared on a minimal diet are available from:

Dr. H.T. Gordon  
Department of Entomology and Parasitology  
University of California  
Berkeley, California 94720

Aposymbiotic cockroaches (deprived of their bacteroids) are available from:

Dr. Marion A. Brooks  
Department of Entomology  
University of Minnesota  
St. Paul, Minnesota 55101

CLASS INSECTA

ORDER HOMOPTERA

FAMILY APHIDIDAE

Myzus persicae (Sulzer), (green peach aphid)

The green peach aphid is a cosmopolitan species and an important vector of many plant viruses.

1. Maintenance

a. Equipment

A special cage, which presents the aphids with the diet enclosed in a parafilm sachet, has been described by Mittler and Dadd (1964).

b. Feeding

(1) Natural host

The aphid shall be reared on seedlings of yellow mustard, Brassica campestris (L.), or leaf mustard, Brassica juncea Coss.

(2) Holidic medium

Myzus persicae shall be fed through an artificial membrane in absence of its host plant.

Synthetic diets adequate for the development of apteriform and alatiform larvae from birth to the adult stage are listed by Dadd and Mittler (1965). Since these diets are currently being improved, the composition of the latest optimal diet should be obtained directly from Dr. T.E. Mittler.

2. Exposure

- a. A suspension, filtrate, or extract of the lunar sample shall be added to the liquid diet.
- b. Aphids shall be exposed directly to the lunar sample while restricted in the small feeding cages.

### 3. Assessment

a. The effect of the lunar sample shall be determined by the following criteria:

Survival rate

Mean growth rate

Maturation time

Fertility of the adults

Reproductive indices

b. The lunar sample may modify the ability of Myzus persicae to transmit one or more plant viruses. An experimental procedure could be planned to test the vector ability of exposed aphids. A plant pathologist should be consulted.

### 4. References

Mittler, T.E. and R.H. Dadd. 1964. Ann. Ent. Soc. Amer. 54: 139-140.

Dadd, R. H. and T.E. Mittler. 1965. J. Insect Physiol. 11: 717-743.

### 5. Source

Dr. T.E. Mittler

Department of Entomology and Parasitology

University of California

Berkeley, California 94720

## CLASS INSECTA

## ORDER LEPIDOPTERA

## FAMILY GALLERIIDAE

Galleria mellonella (Linnaeus), (greater wax moth)I. Maintenance

## a. Rearing

## (1) Xenic method

## (a) The insects are reared on the following medium:

Honey (sage, clover, or orange blossom: strained)	100 ml
Glycerine	100 ml
Water	50 ml
Vitamins (Deca-Vi-Sol teaspoon vitamins, Mead Johnson Laboratories)	5 ml
Precooked mixed cereal (Pablum, Edward Dalton Company)	1200 ml (not packed)

The liquids are mixed together and then the Pablum stirred in. The medium is placed in one-gallon, wide-mouth jars to a depth of one and one-half to two inches.

Three or four folded paper towels are placed in each jar to facilitate harvesting of the larvae. The larvae extend their feeding tubes up into the paper and can be easily retrieved by unfolding the towels (Roberts, 1966).

(b) Six-day old test larvae are placed singly onto pellets of food using a very fine brush. Each larvae is then placed into a 15 x 50 mm plastic vial stoppered with a plug of non-absorbent cotton.

The food pellets shall be prepared as follows: The lunar sample or an extract is stirred into the honey-glycerine-

vitamin mixture, which in turn is well mixed with the Pablum. The food mass is pressed into a Petri plate until the plate is filled level. Even-sized pellets of food are cut with a number 2 cork borer. These pellets can be easily ejected from the borer into the vials (Burgess).

(2) Axenic method

Surface sterilization of Galleria mellonella eggs and preparation of an aseptic diet are described in detail by Waterhouse (1959). The composition of the diets should be obtained directly from Dr. Waterhouse.

b. Temperature

The colony shall be held at 30°C.

2. Exposure

- a. The lunar sample shall be placed in small rearing containers in contact with the larvae.
- b. A suspension filtrate or extract of the lunar sample shall be incorporated into the larval food. Twenty-five larvae shall be used for each test group (Burgess).

3. Assessment

The effect of the lunar sample shall be evaluated according to the following criteria:

Survival rate

Mean growth rate

Maturation rate

Fertility of the adults

Reproductive indices

#### 4. References

Burges, D.H., Personal communication to M.E. Martignoni.

Roberts, D.W. 1966. J. Invertebrate Pathol. 8:217-221.

Waterhouse, D.F. 1959. Ann. N.Y. Acad. Sci. 77(2): 283-289.

#### 5. Sources

Mr. G. L. Finney

Division of Biological Control

University of California

1050 San Pablo Avenue

Albany, California 94706

Composition of optimal diet:

Dr. D.F. Waterhouse

Division of Entomology

Commonwealth Scientific and Industrial Research Organization

Canberra, Australia

## CLASS INSECTA

## ORDER LEPIDOPTERA

## FAMILY LYMANTRIIDAE

Hemerocampa pseudotsugata McDunnough (Douglas-fir tussock moth)

1. Maintenance

## a. Pre-conditioning

If the eggs are collected in the fall, they shall be exposed to 5°C for 6-8 weeks in order to fulfill the diapause requirements.

## b. Rearing

- (1) The eggs shall be incubated in plastic Petri dishes.
- (2) At hatching, the larvae shall be transferred to cubes of an artificial (oligidic) diet. This diet is a modified Vanderzant-Adkisson mixture as described by Lyon and Flake (1966).
- (3) Mr. K.M. Hughes, of the Corvallis Forestry Sciences Laboratory, found that the addition of 13 ml of linolenic acid (55%) to the formulation outlined by Lyon and Flake is highly beneficial for the successful completion of the adult metamorphosis.

If larvae only are to be used as test animals, linolenic acid may be omitted.

## c. Temperature

Eggs shall be incubated at 25°C.

2. Exposure

- a. Suspensions or extracts of the lunar sample (5 µl per larva) shall be used in the peroral inoculation of the larvae.

Larvae weighing 70-80 mg shall be used.

- b. Measured amounts of the lunar sample shall be incorporated into the diet.
- c. Intrahemocoelic inoculation of larvae shall be performed using suspensions.



or extracts of the lunar sample in 5 microliter amounts.

The sample shall be added to 0.01 M Tris buffer (2-amino-2-hydroxy-methyl-1-1,3-propanediol), pH 7.0.

### 3. Assessment

- a. The effect of the lunar sample shall be evaluated according to the following criteria:

Survival rate

Mean growth rate

Maturation time

Maturation rate

Fertility of the adults

Reproductive indices

- b. Hemerocampa pseudotsugata larvae are very susceptible to a number of virus diseases. Changes in susceptibility as measured by an increase or decrease of the LD<sub>50</sub> for two viruses should be considered. Isolates are available from Dr. M. E. Martignoni.
- c. Viral induction may also occur, and attempts should be made to detect it. The diagnosis of the two virus diseases most likely to occur under stress, nucleopolyhedrosis and cytoplasmic polyhedrosis, is relatively easy.

If a test of this type will prove feasible as part of the lunar sample testing program, detailed instructions can be obtained from Dr. M. E. Martignoni. Reagents for the immunohistochemical diagnosis of nucleopolyhedrosis are also available from Dr. Martignoni.

### 4. Reference

Lyon, R. L. and Flake, H. W., Jr., 1966. J. Econ. Entomol. 59(3):696-698.

5. Source

Surface-sterilized post-diapause eggs are now available in limited quantities throughout the year from:

Dr. M.E. Martignoni  
Forestry Sciences Laboratory-U.S.D.A.  
3200 Jefferson Way  
Corvallis, Oregon 97331.

## CLASS INSECTA

## ORDER COLEOPTERA

Tenebrio molitor (mealworm)1. Maintenancea. Equipment

Tenebrio shall be kept in covered containers, glass beakers, or jars.

b. Rearing

(1) The mealworm can be raised on diet of rolled oats (Quaker Oats®), bran, or other grains. This furnishes the substrate to which apples, dried vegetables, and dog biscuits may be added.

(2) The colony can be maintained at room temperature. Higher temperatures are preferable for breeding (28 - 30°C).

(3) The optimal relative humidity is 80%.

2. Exposure

a. The lunar sample, as a powder or sediment, shall be mixed with the substrate which is also in the food. It should be readily ingested during normal feeding by the larval forms.

b. All stages of the life cycle--larvae, pupae, adults and eggs--shall be simultaneously exposed by surface contact.

3. Assessment

a. The survival, growth, and development of the larvae shall be observed.

b. The maturation rate shall be determined.

c. The mealworm shall be held for the completion of its life cycle and the effect of the lunar material on the cycle, determined by a comparison with the control.

#### 4. References

Anon., 1954, Mealworms, U.S.D.A. Leaflet No. 195.

Fraenkel, G., M. Blewett, and M. Coles, 1950, The Nutrition of the Mealworm, Tenebrio molitor (Tenebrionidae Coleoptera), *Physiol. Zool.* 23: 92-108.

Lutz, et al., 1959, Culture Methods for Invertebrate Animals, Dover Publications, Inc., New York, New York.

The UFAW Handbook on the Care and Management of Laboratory Animals, 1967, 3rd edition, Williams and Wilkins Co., Baltimore, Maryland.

#### 5. Source

General Biological Supply House (Turtox)

## CLASS INSECTA

## ORDER COLEOPTERA

## FAMILY CURCULIONIDAE

Anthonomus grandis Boheman, (boll weevil)1. Maintenancea. Rearing

- (1) A meridic diet has been developed by Venderzant and her associates (1959, 1963). The latest improvements of this diet have been considered in the formulation of a mixture suitable for boll weevil larvae and adults (Sterling and Adkisson, 1966).

The major portion of the vitamin mixture is available commercially as "Vanderzant Modification Vitamin Mixture."

- (2) An aseptic rearing method has been described in detail by Vanderzant and Davich (1958).

Eggs shall be sterilized using a germicidal bath.

## b. Temperature and Lighting

No special conditions are required.

2. Exposure

- a. Measured amounts of the lunar sample extracts shall be incorporated in the solid diet.
- b. Eggs shall be bathed in graded concentrations of the suspension or extracts.

3. Assessment

The effect of the lunar sample shall be evaluated according to the following criteria:

Survival rate

Maturation time

Maturation rate

Fertility of the adults

Reproductive indices

#### 4. Reference

Sterling, W.L., and P.L. Adkisson, 1966. J. Econ. Entomol. 59: 1074-1077.

Vanderzant, E.S., 1963. J. Econ. Entomol. 56: 357-362.

Vanderzant, E.S. and T.V. Davich, 1958. J. Econ. Entomol. 51: 288-291.

#### 5. Source

Vanderzant Modification Vitamin Mixture:

Nutritional Biochemicals Corporation  
21010 Miles Avenue  
Cleveland, Ohio 44128

A laboratory strain of Anthonomus grandis (established in 1957) can be obtained from:

Dr. Erma S. Vanderzant  
Entomology Research Division  
U.S. Department of Agriculture  
College Station, Texas

## CLASS INSECTA

## ORDER HYMENOPTERA

## FAMILY APIDAE

Apis mellifera Linnaeus (honey bee)1. Maintenance

## a. Equipment

Observation hives shall be used.

## b. Rearing

- (1) Observation hives do not require much attention; the bee workers will care for the progress and health of the colonies.
- (2) Larvae can be obtained from combs with both capped and uncapped brood by a method described in detail by Daly (1964).
- (3) The larvae can then be reared singly in gelatin capsules, according to a modification of the Jay technique (Daly, 1964).

2. Exposure

- a. Measured amount of the lunar sample shall be introduced in the artificial Jay cells for various periods of time.
- b. Measured amounts of suspensions or of extracts of the lunar sample shall be introduced by means of a microsyringe and 25-gauge hypodermic needle in the larval food (Rotherbuhler and Thompson, 1956).

One row of larvae in a comb should be used as control for each two rows of test larvae (Barrick and Rotherbuhler, 1961).

3. Assessment

- a. The effect of the lunar sample shall be evaluated according to the following criteria:

Survival rate

Mean growth rate

Maturation time

Maturation rate

Fertility of the adults

Reproductive indices

- b. Apis mellifera is a social insect, with castes, and as such it offers an opportunity to detect behavioral abnormalities caused by exposure to the lunar sample.

Adult workers developing from larvae which survived the exposure to the lunar sample can be marked and observed in the colonies.

Rejection or abnormal behavior should be noted and interpreted.

#### 4. Reference

Daly, H.V., 1964. University of California Publications in Entomology 39: i-77. (University of California Press, Berkeley, California).

Hitchcock, J.D., 1966. J. Econ. Entomol. 59: 1154-1156.

Bamrick, J.F. and W.C. Rothenbuhler, 1961. J. Insect Pathol. 3: 381-390.

Rothenbuhler, W.C. and V.C. Thompson, 1956. J. Econ. Entomol. 49: 470-475.

#### 5. Source

Observation hives are recommended:

General Biological Supply House, 8200 South Hoyne Avenue, Chicago, Illinois, 60620, (Catal. No. 220 A 18).



## CLASS INSECTA

## ORDER DIPTERA

## FAMILY CULICIDAE

Anopheles quadrimaculatus Say (common malaria mosquito)

1. Maintenance

## a. Rearing

- (1) Eggs shall be used to produce larvae and adults.
- (2) Guinea pigs or rabbits shall be provided to maintain adult mosquitoes, if tests are to be extended to that stage.
- (3) The step-by-step rearing procedure outlined by Trembley (1955, pages 14-15) is recommended.
- (4) A standardized feeding technique has proved quite successful with Aedes aegypti adults (Gerberg et al., 1966). The same technique may prove feasible for Anopheles quadrimaculatus.

## b. Temperature and Lighting

No special conditions are required.

2. Exposure

## a. Larvae

Aliquots of the lunar sample or extracts shall be added to the solution in the larval culture trays.

Larvae shall be inoculated directly with modified forceps (Clark, 1966).

## b. Adults

Suspensions or extracts of the lunar sample shall be fed directly to adult mosquitoes by means of cotton balls or of paper pads soaked in the test solution.

### 3. Assessment

The effect of the lunar sample shall be evaluated according to the following criteria:

Survival rate

Mean growth rate

Maturation time

Maturation rate

Fertility of the adults

Reproductive indices

### 4. Reference

Trembley, H.L., 1955. American Mosquito Control Association Bull. No. 3: 1-73 (Mosquito Culture Techniques and Experimental Procedures).

Clark, T.B., 1966. J. Invertebrate Pathol. 8: 425-426.

Gerberg, E.J., L.T. Richard, and J.B. Poole, 1966. Mosquito News 26: 359-363.

### 5. Source

Mosquito colonies are available in many public-health and parasitology laboratories (Universities, State Laboratories U.S. Department of Agriculture) as well as at the Communicable Disease Center, Public Health Service, Atlanta, Georgia 30333.

## CLASS INSECTA

## ORDER DIPTERA

Drosophila melanogaster (fruit fly)

A wild-type strain known as "Canton S," which has a low natural mutation frequency, is recommended.

1. Maintenance

## a. Equipment

The conventional containers for breeding large numbers of Drosophila are half-pint milk bottles.

## b. Lighting

No special conditions are required.

## c. Temperature

The optimal temperature is 24-25°C.

## d. Humidity

The optimal humidity is 40-59%.

## e. Culture

(1) The substrate shall be a cornmeal, syrup, and agar mixture.

(2) The formula for the culture medium is as follows:

Yellow cornmeal	125 gm
Dried Brewer's yeast	25 gm
Agar	20 gm
Sulfur-free cane syrup	125 ml
Propionic acid	11.5 ml
Cold water	1,223 ml
Live yeast (Fleishmans)	1 cake

Mix dry ingredients well. Add syrup; mix well. Add water; mix well. Cook in double boiler for 30 minutes on low heat, stirring occasionally so that the food will not stick. At the end of the cooking time, stir in proprionic acid. Put food on medium heat; let come to boil and pour.

- (3) This makes about 24 half-pint milk bottles. Pour about 3/4-inch thickness of food into each previously sterilized bottle. Immediately add three drops of a thick suspension of live yeast to each bottle. Cover completely by putting bottles into a tray and enclosing the tray in a cotton sack. Allow to dry overnight at 24-25°C. Before use, add 2-inch squares of cellucotton (or pieces of sterile cotton) to each bottle and push them down into the food, using a flamed glass rod. The larvae will crawl up and pupate on the cellucotton. Stoppers may be made of sterile cotton, or "dispoplugs" made of styrofoam.

#### f. Handling

- (1) It will be necessary to etherize the flies before they are put into the food bottles. This is accomplished by shaking the flies from a newly-hatching culture bottle of "Canton S" stock into an empty half-pint milk bottle and closing it tightly with a cork stopper to which has been tacked a piece of absorbent cotton freshly soaked in anaesthetic ether.
- (2) The flies will fall to the bottom of the bottle within two or three minutes. When they have all fallen onto their sides, they are etherized sufficiently to remain anaesthetized for 15 or 20 minutes. Caution shall be used to see that they are not etherized too long, as manifested by their wings being held over their bodies and their legs being held in a completely straightened-out position.

- (3) Shake them out onto a white counting board (Formica plates 2-1/2 x 5 inches in size).
- (4) It is suggested that virgin females be collected by shaking out and discarding all the flies from a freshly-hatching culture at about 4 o'clock in the afternoon, and holding the culture until the following morning. Then shake out and etherize by 9 a.m. the flies that have hatched overnight and separate males from females, using a small brush to move them around. The yielding culture bottle can be emptied again at about 4 p.m. the same afternoon and a further separation of sexes made.
- (5) In transferring the etherized flies to a fresh food bottle, the etherized flies should fall onto the cellucotton to prevent their sticking in the food.
- (6) Hold each sex in separate food bottles until ready to start the test.
- (7) The freshly-hatched Drosophila male does not mature until 18 hours after hatching; thus this procedure insures that the females have not mated.

## 2. Exposure

- a. The bottles shall be divided into two lots of ten each. In one lot a solution containing the lunar sample shall be added to the food just after it has been poured.
- b. Since the food will still be hot, a small amount of the solution shall be dropped directly onto the cellucotton in each bottle to avoid the possibility of killing any heat-labile substance in the sample.

- c. The other ten bottles shall serve as controls grown on normal culture medium.
- d. Five of the isolated males and five virgin females shall be added to each of the bottles. These are then stoppered and set aside to propagate.
- e. The adult parents and the developing offspring shall be exposed to the food containing the lunar sample throughout their entire life cycle.
- f. Since the developmental stages are temperature dependent, it is highly important that the "treated" and the control culture bottles be maintained at the same temperatures.
- g. The life cycle at 24-25°C is as follows:
  - (1) Mating will take place after 24 hours from the time the parent flies are etherized (if virgin females and isolated males are used).
  - (2) Eggs will be laid as soon as the females are fertilized, and by the third day there should be enough eggs laid to be visible to the naked eye as tiny white specks on the surface of the food. The females continue to lay eggs on food unworked by larvae for about 5 days.
  - (3) Larvae only slightly larger than the eggs hatch out at about 30 hours after the fertilized eggs are laid. These burrow into the food and grow at a fast rate, becoming full-grown larvae (third instar) on about the 5th day after the culture was started. They climb up onto the cellucotton and the sides of the bottle, become motionless, and pupate by the 6th day.
  - (4) The pupal stage lasts about 5 days, when the adults emerge.

### 3. Assessment

- a. A daily comparison of the survival of the parents and the rate of growth of the progeny of the cultures containing the lunar sample and the controls

should reveal gross differences in survival of the adults or in the developmental rate.

- (1) Survival differences must be determined by actually counting the adults hatching in each of the groups.
  - (2) It is customary to empty such cultures three times after they begin to hatch, etherizing and counting the progeny each time.
  - (3) They must not be emptied after the 21st day after they were originally started, since second-generation progeny will be obtained. The effect of the sample would be expected to be diluted and the effects of semi-starvation would tend to obscure the results.
  - (4) About 500 offspring will be expected to hatch from each bottle, giving roughly 5,000 in the experimental and 5,000 in the control series of bottles.
- b. A slightly more laborious test shall be used in order to detect early death, such as in the egg stage, by using bottles furnished with food resting on removable spoons. The usual bottles shall be used if the food is carefully removed after egg-laying.
- (1) The surface of the food in the spoons shall be directly scanned under a microscope after removal from the bottles or on the food removed from the bottles.
  - (2) The number of eggs laid and hatched shall be compared with the number of adults that develop in the culture bottles.
  - (3) A larger number of eggs laid as compared with adults hatching from exposed cultures would indicate a toxic effect resulting in death of the developing embryo when compared with the controls.
- c. Toxic effects acting directly upon the parent flies should be noticed

within a week. Effects on survival of the progeny which have been fed on the lunar sample would be apparent by the end of two to three weeks.

- d. If radioactivity is present in the sample, it would seem desirable to do a simple test for the possible production of mutations. The chemical nature of the sample may also be such that mutations are produced by it. A fairly simple genetic test shall be run in addition to the survival and rate of development test that will give a reliable estimate of the mutation rates in the two series. The "Muller-5" method shall be used to detect recessive lethal mutations in the X chromosome.
- (1) Newly hatched "Canton S" males shall be injected abdominally with a solution of the lunar sample. Saline solution and a terrestrial-soil solution shall be injected in two control series.
  - (2) Injected males shall be crossed with virgin females of the "Muller-5" stock instead of to virgin "Canton S" females.
  - (3) When the daughters hatch, they must be bred individually to their brothers.
  - (4) The progeny of each resulting culture shall be scanned (without etherization) for the production of "Canton S" males. Any culture in which these males are absent represents a separate lethal mutation produced in a mature sperm cell of the treated father.
  - (5) It would be necessary to test about 1,000 of the daughters of the treated males, which could easily be obtained from two or three original culture bottles.
  - (6) The "spontaneous" or naturally occurring mutation rate in this stock is one or two lethals per 1,000 cultures. Dominant lethals induced in the X chromosome of the treated male would show by a lowered



ratio of females to males (normally about equal) among the progeny and also by a lowered viability of the developing eggs and their hatchability.

e. If a slight modification of the procedure for setting up the two series of ten bottles each (comprising the survival and development test) is made, it would be possible to test for mutations that might have been produced in their offspring which have been fed food containing the lunar sample during their entire life cycle.

- (1) The modification necessary would be the substitution of "Muller-5" males as the parent flies instead of "Canton S."
- (2) Since the male and female offspring that hatch may carry recessive lethals among their germ cells, it would be necessary to breed to a further generation to detect these mutations.
- (3) About 50 of the daughters that hatch should be bred individually to males from another stock which are designated as b137. From each female about 20 daughters should be tested again by crossing to b137 males for lethals.
- (4) The males from the original cross would be "Canton S," and these could be tested for lethals in the standard way by crossing to "Muller-5" males and then testing their daughters for lethals.
- (5) The genetic tests would require six to seven weeks to complete.

4. Source

"Canton S" strain:

Dr. Edgar Altenburg  
Genetics Laboratory  
Rice University  
Houston, Texas 77001

## CLASS INSECTA

## ORDER DIPTERA

## FAMILY CALLIPHORIDAE

Phormia regina (Meigen), (black blow fly)

1. Maintenance

## a. Rearing

Axenic cultures of the blow fly from egg to adult shall be established from surface-sterilized eggs.

Eggs for the axenic larval cultures are obtained from xenic stocks.

The culture medium (meridic) is a casein and vitamin mix, described by Cheldelin and Newburgh (1959).

The larvae grow at a very fast rate and complete the larval stage at the fifth or sixth day.

For continuous propagation, adult flies shall be maintained in xenic stock cultures.

## b. Temperature and Lighting

The culture shall be maintained at 30°C.

2. Exposure

Varying concentrations of the extracts or filtrates of the lunar sample shall be aseptically added to the larval culture medium.

Filtrates shall be obtained by passage through a graded series of filters (e.g. Millipore).

3. Assessment

a. Both daily weight gain and larval length shall be measured. In sub-optimal rearing conditions the response of the two characteristics differs considerably (Cheldelin and Newburgh).

- b. The proteolytic activity in extracts of media shall be used as an indicator of possible lesions. The preparation of the medium extracts and the proteolytic assay (Kunitz method) have been described by Brookes (1961a).

The assay of the proteolytic activity in the medium should prove adequate in an initial series of tests.

- c. The amino acid metabolism level of intact fat bodies of axenic larvae shall be used as another indicator of possible lesions produced by the sample.

A method using C<sup>14</sup> amino acids as substrates has been mentioned by Brookes (1961b). Details of this method are not published. Dr. Brookes has agreed to furnish a step-by-step protocol, if so requested.

The determination of amino acid metabolism levels by isolated fat bodies shall be considered if more subtle effects of the lunar sample are suspected.

#### 4. Reference

Brookes, V.J., 1961a. *Biochim. et Biophys. Acta* 46: 13-21.

Brookes, V.J., 1961b. *Amer. Zool.* 1(3): 104.

Cheldelin, V.H. and R.W. Newburgh, 1959. *Ann. N.Y. Acad. Sci.* 77(2): 373-383.

#### 5. Source

Dr. V.J. Brookes  
Department of Entomology  
Oregon State University  
Corvallis, Oregon 97331

## TISSUE CULTURE PROCEDURES

## ORDER LEPIDOPTERA

Insect cell strains from the lepidopteran Antheraea eucalypti. Scott (Saturniidae) have been established by Grace (1962) and are available for testing.

1. Maintenance

The composition of the culture medium has been described by Grace (1962) and the medium is commercially available.

Lobster blood plasma, also commercially available, may be substituted in place of insect blood plasma.

2. Exposure

Measured amounts of the lunar sample in suspension or extract shall be added to the cultures

3. Assessment

Changes in cellular proliferation and metabolic activity, as well as cytopathic effects shall be detected and measured or described according to usual tissue culture procedures.

4. Reference

Grace, T.D.C. 1962. Nature 195: 788-789.

Grace, T.D.C., 1966. Establishment of a Line of Mosquito (Aedes Aegypti L.) Cells Grown in vitro. Nature 211: 366.

5. Source

Culture medium and lobster blood plasma:

Grand Island Biological Company  
3175 Staley Road  
Grand Island, New York 14072

(Catalog No. 159).

Cultures can be obtained from various research laboratories in the United States. Information on suppliers of this saturniid cell strain can be obtained from:

Dr. M.E. Martignoni  
Forestry Sciences Laboratory  
U.S.D.A.  
3200 Jefferson Way  
Corvallis, Oregon 97331

For information on additional insect cell lines or culturing the following individuals should be consulted:

Order Diptera

Dr. Earl C. Sutor  
Naval Medical Research Institute  
National Naval Medical Center  
Bethesda, Maryland 20014

Order Homoptera

Dr. Karl Marmorosch  
Boyce Thompson Institute for Plant Research  
Yonkers, New York 10702

Order Orthoptera

Dr. Edwin P. Marks  
Department of Biology  
Washburn University  
Topeka, Kansas 66601

PHYLUM CHORDATA

THE PROTOCHORDATES

SUBPHYLUM TUNICATA

CLASS ASCIDIACEA

Ciona intestinalis (sea squirt)

1. Maintenance

a. Equipment

- (1) Animals shall be kept in an aerated aquarium.
- (2) Unfiltered normal sea water shall be used.

b. Feeding

The animals are filter feeders and require unfiltered normal sea water containing small diatoms and algae.

c. Temperature

- (1) The preferred temperature is 15°C.
- (2) Animals will survive up to 25°C.

2. Exposure

- a. The lunar sample or an extract shall be added to the sea water.
- b. A suspension or an extract of the sample shall be injected into the siphon or soma.

3. Assessment

- a. The behavior shall be observed for simple tests of short duration:  
The response of the siphons and test to mechanical stimuli shall determine the normal activity.

The sensitivity of the test to mechanical stimuli can be investigated by touching selected regions of the test and each siphon with the tip of a dissecting needle.

The test is believed not to contain sensory nerves but to transmit the pressure of such mechanical stimuli to nerves lying in the mantle tissue directly underneath the test. Two types of reflexes have been observed in the responses of tunicates.

- (1) Direct reflexes result from mechanical stimulation of the body surface.

A gentle stimulus results in contraction of the siphon nearer the point of stimulation

If the stimulus is stronger, not only the siphon nearer the stimulated point, but also the other siphon will close.

A vigorous mechanical stimulus results in contraction of both siphons and the body.

- (2) Crossed reflexes result from stimulation of the interior surface of the siphons.

A delicate stimulus on the inside of one siphon results in a closure of the other siphon, the stimulated one remaining open.

- b. The rate of filtration shall be determined. Tests described for molluscs shall be applied.

#### 4. Reference

Brown, Jr., F.A. Selected Invertebrate Types. John Wiley & Sons, Inc. 1950.

Lutz, et al. Culture Methods for Invertebrate Animals. Dover Publications, Inc., New York, 1959.

#### 5. Source

Supply Department, Marine Biological Laboratories, Woods Hole, Mass.

## SUBPHYLUM CEPHALOCHORDATA

Branchiostoma (amphioxus)1. Maintenance

## a. Size

Two-inch animals shall be used.

## b. Equipment

- (1) Animals shall be kept in a sea water aquarium.
- (2) There shall be a 2-inch bottom of coarse sand in the aquarium.
- (3) A 5-gallon aquarium shall be used for long-term experiments.
- (4) Fingerbowls shall be used for short-term experiments.

## c. Feeding

- (1) The naturally occurring flora of the sea water shall be allowed to perpetuate.
- (2) Amphioxus are filter feeders and require unfiltered normal sea water.

## d. Handling

A plastic mesh net shall be used.

## e. Temperature

Ambient 20-25°C

## f. Light

A normal LD ratio shall be maintained.

2. Exposure

- a. The lunar sample or extract shall be added to the sea water in a large fingerbowl. The animals shall be exposed from 2 to 4 hours.
- b. The lunar sample shall be added to the aquaria in the following proportions:

0.5 gm/5 gal. H<sub>2</sub>O

1.0 gm/10 gal. H<sub>2</sub>O



### 3. Assessment

- a. Observation shall be made of any changes in morphology.
- b. Observations shall be made of any behavioral changes. The normal animal, when disturbed, darts rapidly, then becomes extremely rigid and floats, giving the appearance of a dead fish. Within a few minutes (8 minutes) the animal swims and immediately burrows.
- c. Amphioxus shall be fixed in toto.

### 4. Reference

A.S. Romer, The Vertebrate Body, W. B. Saunders Co., 1956.

### 5. Source

The amphioxus is readily available locally (the Gulf).

## THE VERTEBRATA

SUBPHYLUM AGNATHA (fish without jaws)

CLASS CYCLOSTOMATA

Ichthyomyzon (Michigan brook lamprey)

1. Maintenance

a. Size

The small ammocoetes larvae shall be used.

b. Equipment

(1) A layer of coarse sand shall cover the bottom of the aquaria.

(2) The water shall be aerated but not filtered.

(3) Finger bowls or beakers shall be used for short-term exposure and experiments.

c. Feeding

The young are filter feeders.

d. Temperature

12-15°C.

2. Exposure

A suspension or an extract of the lunar sample shall be added to the water.

3. Assessment

The development, growth, and morphology of the larvae shall be observed.

4. Reference

Reichenback-Klinke, H. and E. Elkan. The Principal Diseases of Lower Vertebrates. Academic Press, London & New York, 1965.

5. Source

Turttox General Biological Supply, Chicago, Illinois.

**PISCES****CLASS CHONDRICHTHYES****ORDER SELACHII (ELASMOBRANCHII)****Mustellus canis (smooth dogfish shark)****1. Maintenance****a. Size**

The young "pups" shall be used.

**b. Equipment**

An aerated, filtered, running salt-water aquarium shall be used.

**c. Feeding**

The young have an attached yolk sac. They require no feeding.

**d. Handling**

Approximately one-half dozen young sharks (several inches long) can be kept in a 15-gallon aquarium.

**e. Temperature**

Cold water is necessary.

**2. Exposure****a. The lunar sample shall be added to the aquarium water, 3 gm/15 gallons.**

If the amount of lunar sample is limited, the young sharks shall be exposed to the same ratio for two hours while being held in a large beaker.

**b. In addition, one-half of the sharks shall receive a double exposure to the lunar sample. They shall be injected intraperitoneally with a suspension of the sample, 0.1 gm/shark, suspended in physiological saline.**

Animals receiving an additional exposure shall be segregated by perforated lucite dividers placed in another aquarium or tagged. If

tagging is necessary, it shall be carried out prior to the test period.  
Control fishes shall be tagged by an identical procedure.

3. Assessment

- a. The effect of the lunar sample on the morphology and development of the growing shark shall be determined.
- b. Skin color change and loss of orientation shall be used as an indication of sickness.

4. Source

Marine Biological Supply, Woods Hole, Massachusetts.

## CLASS OSTEICHTHYES

## ORDER HOLOSTEI

Amia calva (bowfin)

A primitive bony fish.

1. Maintenance

## a. Equipment

Aerated and filtered fresh-water aquaria are required.

## b. Handling

(1) 1" fish/gallon of water for large fish shall be used to establish the proper number of fish to be kept in an aquarium.

(2) This specie is known to be tenacious of life and can live many hours out of water.

2. Exposure

a. Varying concentrations of the lunar sample shall be added to the aquaria water.

b. A suspension or extract of the lunar sample shall be injected intraperitoneally or intramuscularly.

3. Assessment

Observation shall be made on the effect of long-term exposure on the normal biology of this species.

4. Source

Mr. J. Thomas Whitman  
Sea-Arama  
91st and Seawall  
P.O. Box 69  
Galveston, Texas 77550

## CLASS OSTEICHTHYES

## ORDER TELEOSTEI

Lebistes reticulatus ( guppy )

The guppy is well-suited for the quarantine testing of the lunar sample. It is a very small species. All stages of its life cycle can be tested simultaneously within the confines of a small aquarium.

1. Maintenance

## a. Equipment

- (1) An aerated and filtered fresh-water aquarium shall be used.
- (2) Floating "breeding cages" for young may be provided in the aquarium.

## b. Feeding

A commercially prepared guppy diet shall be used.

## c. Handling

A large number of fish can be maintained in a 15-gallon aquarium.

2. Exposure

All stages of the life cycle shall be simultaneously exposed to the lunar sample which shall be added to the aquarium water.

3. Assessment

- a. The sex of guppies is easily determined. The effect of the lunar sample on the morphology and survival rate of the different sexes shall be determined.
- b. Guppies are live bearers. The ability of the female to bear young after exposure shall be determined.
- c. The rate of survival and the growth and development of the young shall be studied.

4. Reference

Reichenback-Klinke, H. and E. Elkan. The Principal Diseases of Lower Vertebrates. Academic Press, N. Y., 1965.

5. Source

Locally available.

## CLASS OSTEICHTHYES

## ORDER TELEOSTEI

Commercially important fish:

Pimephales promelas (fat-head minnow)

Salvelinus fontinalis (brook trout)

Oncorhynchus (Pacific salmon)

1. Maintenance

## a. Size

- (1) Disease-free juveniles (fry) shall be used. Fry are more susceptible to disease than adults.
- (2) Fish shall be 3" in length. No fish shall be less than 2".

## b. Equipment

(1) Aquaria

- (a) Three 15 or 20 gallon aquaria shall be recessed in the bottom of hood to facilitate handling of fish.
- (b) Types of aquaria
  - 1) Regular commercial aquaria are recommended.
  - 2) Salt-water aquaria are commercially available.
  - 3) Some species are sensitive to the glue or cement used to fabricate commercial aquaria. If this occurs with the test species, lucite aquaria shall be made using chloroform or acetate to cement the edges.
- (c) Each aquarium shall be subdivided into 3 to 5 units by using perforated lucite dividers.
- (d) Tanks shall be covered with glass or lucite plates.

The sides of the tanks shall be shielded with an opaque shell between periods of observation. Paper or aluminum foil can be used.

(e) Each aquaria shall have a closed water system.

(2) Aerators and filters

(a) Filters shall be used according to the conditions described in the General Instructions.

(b) Each aquarium shall have a ceramic aerator and a continuous flow filter. These two elements shall be on separate air sources: i.e., from two separate air compressor units.

(c) The filter unit shall contain activated charcoal covered with special filter wool. Glass wool shall be changed weekly.

(3) Miscellaneous equipment

(a) Transparent plastic mesh nets shall be used.

(b) Twenty-nine gauge needles shall be used for small fish.

(c) Glass beakers shall be used during the exposure.

c. Food

Commercially available aquarium food such as Tetramin shall be used.

This shall be sterilized.

d. Temperature

(1) Ambient temperature (23°C) shall be used if constant. Otherwise, commercial aquarium heaters shall be used. Avoid using heater unit if possible.

Room temperature may be suitable for salt water fish.

(2) Refrigerator systems

Cold water fish shall be maintained at 13°C. An immersion cooling unit shall be used.

e. Water

(1) Fresh water



(a) Fresh water free of chlorine shall be used. Sterilized (autoclaved) tap water can be used for fresh-water fish.

(b) Water shall be aerated several days before the fish are placed in the tanks.

(2) Salt water

Commercial salt mixtures such as "Instant Ocean" shall be used for salt water aquaria.

f. Handling

Preconditioning:

- (1) Fish shall be held at least one month before use and observed for signs of disease.
- (2) Each specie shall be kept separate.
- (3) A dozen 3" fish can be kept in a 5 gallon unit.
- (4) Fish placed under natural stress\_s may be more sensitive to challenge.

e.g.: Crowding

Decrease in O<sub>2</sub> tension

Sudden temperature change

Ammonia

2. Exposure

a. Direct Environmental Exposure

- (1) A suspension or an extract of the lunar sample shall be added to aquaria in at least 10 parts per million concentration or higher.  
If sample economy excludes this then:
- (2) Fish shall be exposed to this concentration in a smaller volume (as practical and compatible with health of fish) for 30 minutes.  
Fish shall be returned to the aquarium.

## b. Injection

### (1) Intramuscular injection

Fish to be injected shall be individually anesthetized by transfer from the aquarium to a 1 liter beaker containing Sandoz MS-22 (tricane methanesulfate).

Remove fish as soon as inactive, place in sterile plastic mesh net, and inject material through net into dorsal muscle of fish using 30-gauge hypodermic needle.

Fish shall be returned to aquarium as rapidly as possible.

### (2) Dosage

0.1 ml of a Tyrodes Solution containing 10 mg sample per ml shall be injected intramuscularly.

### (3) Intraperitoneal injection

This is not recommended for small fish. There is danger of puncturing intestine.

## 3. Assessment

### a. Observations

#### (1) Macroscopic

Fish shall be observed daily for the following deviations from the normal:

- (a) Erratic movements (i.e. "stagers")
- (b) Settling to the bottom
- (c) Change in rate of opercular movement
- (d) Loss of balance
- (e) Reddening and inflammation around base of fins and mouth
- (f) Change in appearance of fins
  - 1) Fraying
  - 2) Fungal growth
- (g) Change in character of fecal material

(h) Fungal growth on surface, especially gills and fins, will look "cottony"

(2) Microscopic

(a) Fish can be killed for autopsy by a blow on the back of the head or by removal from water.

(b) Histopathological studies shall include all organs.

b. Secondary culturing

(1) It is impossible to sterilize the surfaces of fish, so that contamination from this source must be anticipated and identified.

(2) Lesions from diseased fish shall be cultured for microorganisms according to the previously described protocols.

(3) The whole fish or diseased organs shall be homogenized and inoculated into other animals and plants as described in the protocols.

4. References

a. Books

Culture and Diseases of Game Fishes. Davis, 1965, University of California Press.

Fish as Food, Vol. II, Borgtrom, Academic Press.

Viral Diseases of Poikilothermic Animals. Annals of New York Academy of Sciences, Vol. 126, No. 1.

Traite de Zoologie, Tome XIII, Agnathes et Poissons, Masson et Cie Editeurs, 120, Boulevard St. Germain, Paris (VI<sup>e</sup>). No translation.

Frankheiten und Schädigungen der Fische, Reichenbock, Klinke Gustov Fisher Verlag, Stuttgart, 1966.

The Principle Diseases of Lower Vertebrates, Klinke and Elkan, 1965. Academic Press, 111 5th Ave., New York. English translation.

Laboratory Animals, Part II, 6th Ed. 1966, Publ. 1413, National Academy of Sciences, National Research Council, Washington, D.C.

A Guide to the Properties, Characteristics and Uses of Some General Anaesthetics for Fish. Gordon R. Bell, 1964, Bulletin #148, Fisheries Research Board of Canada (Ottawa).

Symposium on Fish Microbiology. Development in Industrial Microbiology, Vol. 5, AIBS 1964, pp. 97-143, Dr. S. F. Snieszko, Washington, D.C.

b. References for consideration:

Dr. Herbert Axelrod  
T.F.H. Publications Inc.  
245 Cornelison Avenue  
P.O. Box 33  
Jersey City, New Jersey 07302

(Large supplies and holding facilities for tropical fish in Florida).

Harborton Marine Laboratory  
P. O. Box 11  
Harborton, Virginia 23389  
301 489-4225

(Rock, bass, trout, common fish)

Richard Reckweg, Curator  
National Aquarium  
Department of Interior Building  
Washington, D.C.

(Expert on aquarium fishes, holding, toxicity of aquarium factors, etc.)

Dr. Carl Sinderman  
Experimental Station  
Bureau of Commercial Fisheries  
Oxford, Maryland

(Expert on crustacea, commercial marine fish)

Dr. Kenneth Wolfe  
Bureau of Sport Fisheries and Wildlife  
Eastern Fish Disease Laboratory  
P.O. Kearneysville  
Leetown, West Virginia

(Expert on and source of fish tissue cultures)

## 5. Sources

Federal experimental fish hatcheries are recommended because of the quality control.

Federal and state fisheries laboratories in the states of Washington and Oregon are recommended as possible source of salmon.

The following are recommended for consideration:

Dr. Fred Meyer  
Fish Farm Experiment Station  
Department of Interior  
Stuttgart, Arkansas

(grass carp, cat fish)

Dr. Michael M. Sigel  
Department of Bacteriology  
University of Miami School of Medicine  
Coral Gables, Florida 33134

(fish cell lines)

Dr. S. F. Snieszko  
Bureau Sport Fisheries and Wildlife  
Eastern Fish Disease Laboratory  
Kerneysville, W. Virginia 25430

(trout)

Dr. Ken Wolfe  
Eastern Fish Disease Lab  
Department of Interior  
Leetown, West Virginia

(fish cell lines)

### Equipment for Fish

Aquarium Systems, Inc.  
1462 E. 289 St.  
Wickliffe, Ohio 44072  
216 944-6000

(Source of ocean water salts and aquaria for maintaining marine fishes. Coding units, etc.)

Marinovich Trawl Co.  
1317 East First St.  
Biloxi, Mississippi

(Fish seines)

## CLASS OSTEICHTHYES

## SUBCLASS CHOANICHTHYES

## SUPERORDER DIPNOI

Protopterus aethiopicus (African lungfish)1. Maintenance

## a. Equipment

- (1) Animals shall be kept in a small aquarium.
- (2) The water may be aerated and filtered.
- (3) The aquarium shall have a mud bottom.

## b. Feeding

Small pieces of beef heart shall be placed in the aquarium.

2. Exposure

- a. The lunar sample shall be added to the water.
- b. The lunar sample shall be incorporated into the food.
- c. A suspension or an extract of the sample shall be injected into coelom.

3. Assessment

Observations shall be made of the normal behavior and biology of the animal.

4. Reference

Smith, H. W., From Fish to Philosopher, Chapter 6, pp. 71-84,  
Doubleday & Co., Inc., Garden City, N. Y., 1961.

5. Source

Small specimens (6-8 inches) are available by direct air shipment from Uganda.

African lungfish(Protopterus aethiopicus):

Paramount Aquarium  
Ardsley, New York

Tiburon Biomarine Preparations  
133 San Fernando  
Galveston, Texas 77550  
Telephone: 713/ SO 3-1770

Mr. J. Thomas Whitman  
Sea-Arama  
91st and Seawall  
P. O. Box 869  
Galveston, Texas 77550

(Experienced in maintaining the African lungfish)



**CLASS AMPHIBIA****SUBCLASS CANDATA (URODELA)**Ambystoma tigrinum (tiger salamander)**1. Maintenance****a. Equipment**

- (1) The animals shall be kept in a damp terrarium.
- (2) Approximately six 8-inch animals can be maintained in a 15-gallon terrarium.

**b. Feeding**

Salamanders shall be fed worms or mealworms (Tenebrio larvae). Beef heart or beef liver cut into narrow strips shall be offered as food.

**c. Temperature**

The preferred temperature is 20°C or lower. They should not be maintained at temperatures higher than ambient (room).

**d. Lighting**

Normal day-night lighting conditions shall be maintained.

**2. Exposure**

- a. A suspension or an extract of the sample shall be injected into the coelom.
- b. The sample shall be incorporated into the food.

**3. Assessment**

- a. The behavior and morphology of the animal shall be observed.
- b. The development of the juveniles shall be compared to that of the controls.
- c. Diagnostic procedures are given in the reference (Reichenbach-Klinke and Elkan, 1965).

**4. Reference**

Hutchinson, R. C., "Amphibia", in *The Care and Breeding of Laboratory*

Animals. London, Chapman and Hall, 1950.

The UFAW Handbook on the Care and Management of Laboratory Animals.

The Williams & Wilkins Co., Baltimore, 1967.

Reichenbach-Klinke, H. and E. Elkan. The Principal Diseases of Lower Vertebrates, Academic Press, N.Y., 1965.

5. Source

General Biological Supply House (Turtox)  
8200 South Hayne Avenue  
Chicago, Illinois 60020

Carolina Biological Supply Co.  
Burlington, North Carolina 27216

## CLASS AMPHIBIA

## SUBCLASS SALIENTIA (ANURA)

Xenopus laevis (the South African clawed toad)

1. Maintenance

## a. Equipment

This aquatic toad shall be kept in an aquarium filled with fresh water.

## b. Feeding

Xenopus shall be fed fresh pieces of meat (horse, rat, or rabbit liver) and living invertebrates such as Daphnia.

## c. Temperature

The animals shall be maintained at normal room temperature or higher.

## d. Handling

(1) This aquatic toad is routinely used for pregnancy tests. It is a very hardy species and can be easily maintained in the laboratory for over a year.

(2) It does not succumb to infections such as the red-leg of Rana or fungal infections of Necturus.

2. Exposure

a. A suspension or extract of the lunar sample shall be added to the aquarium water.

b. The lunar sample shall be incorporated into the food.

c. The lunar sample in aqueous form shall be injected into coelom or musculature.

## 3. Assessment

a. The effect of the lunar sample on the growth and morphology of Xenopus shall be observed.

- b. The diagnostic procedures for identification of infections are given in Reichenback-Klinke and Elkan (1965).
- c. The subtle effects of the lunar sample on metabolism shall be studied.

The nitrogen metabolism of Xenopus has been studied more extensively than for any other amphibian.

The adaptation of nitrogen metabolism during transfer to salt water shall be used as a means of assessing the functional integrity of the animal after exposure to the lunar sample.

#### 4. Reference

The UFAW Handbook on the Care and Laboratory Animals, 1967, 3rd Ed.,  
The Williams and Wilkins Co., Baltimore.

The Principal Diseases of Lower Vertebrates by H. Reichenback-Klinke  
and E. Elkan, 1965, Academic Press, N.Y.

#### 5. Source

For information concerning supply:

Dr. Leon Goldstein  
Department of Physiology  
Harvard University School of Medicine  
Boston 15, Massachusetts

## CLASS AMPHIBIA

## SUBCLASS SALIENTIA (ANURA)

Rana pipiens (leopard frog)1. Maintenance

## a. Equipment

- (1) The adults shall be kept in an aquarium. The bottom shall be covered with one inch of water and changed every few days.

Normally frogs are kept in wire bottom cages with slowly dripping tap water.

The container shall have a close fitting lid of wire mesh or perforated zinc.

- (2) The fertilized eggs and tadpoles shall be kept in glass finger bowls.

## b. Feeding

- (1) The adult can be maintained for some time without feeding. However they remain in better condition when fed. They shall be fed earthworms, flies, or moths.

- (2) The tadpoles shall be fed spinach or lettuce.

Later tadpole stages require a protein diet. This can be provided by high-protein artificial foods or small pieces of meat.

## c. Temperature

Frogs shall be maintained at room temperature.

## d. Handling

- (1) New stock shall be held for a period of 1-2 weeks with daily inspection for red-leg. During this period animals may be held in a 0.15% saline solution or a piece of copper wire placed in the water.
- (2) All three stages keep well in captivity.

## 2. Exposure

- a. The lunar sample shall be added to the aquarium water.

The lunar sample shall be placed in the aqueous environment where the eggs and tadpoles are developing.

- b. The lunar sample shall be incorporated into the food for ingestion by the tadpoles and adults.
- c. A suspension or extract of the lunar sample shall be injected into the coelom of the adult.

## 3. Assessment

- a. The behavior and morphology of the adult frog shall be observed.
- b. The embryonic development of the eggs shall be carefully observed.  
Heritable effects shall be determined to distinguish chemical toxicity from mutation.
- c. The effect of the sample on typical larval development shall be determined.  
Metamorphosis shall be induced with thyroxine, and the effects of the test material can be noted on the metamorphosing tadpoles.  
Embryonic and larval development of the frog has been described in great detail.
- d. Diagnostic procedures for amphibians are given by Reichenback-Klinke and Elkan, 1965.

## 4. Reference

The UFAW Handbook on the Care and Management of Laboratory Animals, 1967, 3rd Ed., The Williams and Wilkins Co., Baltimore.

The Principal Diseases of Lower Vertebrates by Reichenback-Klinke and Elkan, 1965, Academic Press, N.Y.

5. Source

For adults, larvae (tadpoles) and eggs:

General Biological Supply House (Turtox), Chicago, Ill.

Carolina Biological Supply Co.  
Burlington, North Carolina 277216

Ward's Natural Science Establishment, Inc.  
P. O. Box 1712  
Rochester, New York 14603

Ward's of California  
P. O. Box 1749  
Monterrey, California 93942

**CLASS AMPHIBIA****Cell lines**

Frog fibroblastic

Frog epithelioid

**1. Maintenance**

- a. For information concerning the use of amphibian cell lines it is recommended that the individuals listed in the reference and source be consulted.
- b. The cultures shall be tested in antibiotic-free media.
- c. Poikilothermic cells shall be tested through the range of their temperature tolerance.

**2. Exposure**

A suspension or extract of the lunar sample shall be incorporated into the culture media.

**3. Assessment**

The effect of the lunar sample on tissue cultures shall be determined, both macroscopically and microscopically.

**4. Reference and Source**

Dr. Kenneth Wolfe  
Bureau of Sport Fisheries and Wildlife  
Eastern Fish Disease Laboratory  
P. O. Kearneysville  
Leetown, West Virginia

(Frog fibroblastic)

Dr. Keen A. Rafferty, Jr.  
The Johns Hopkins University School of Medicine  
725 North Wolfe Street  
Baltimore, Maryland 21205

(Frog epithelioid)



## CLASS REPTILIA

## ORDER CROCODILIA

Caiman latirostrisAlligator mississippiensis

Juvenile caimans or alligators (3-4 months old) approximately 8-12" in length shall be used. Young raised from eggs collected prior to hatching shall be used to obtain animals relatively free of microorganisms.

The caiman is more readily available.

1. Maintenance

## a. Equipment

## (1) Cage

(a) Three 15-gallon aquaria shall be used.

(b) Shallow containers 2' x 1' x 1' may also be used.

(2) One-half inch mesh screen wire shall be used to cover the top of the container.

## b. Water requirements

The reptile prefers to be out of water most of the time. If the animal is immersed in water, the skin will become soft and sensitive to handling.

(1) A shallow container filled with water shall be placed in the cage if aquaria are not used.

(2) The aquaria shall be filled with a small amount of water to a depth of 2-3 inches.

The floor shall slope gradually to provide land.

## c. Temperature

Caimans shall be held at 27-30°C.

Alligators shall be held at 24-30°C.

d. Lighting

General Electric sun lamps may be used for approximately 15 minutes per day to prevent growth of molds and fungi.

e. Feeding

- (1) Beef melt (spleen) shall be used as food.
- (2) Small alligators may eat every day. They must be fed at least two times a week.

f. Handling

The reptiles shall be held at least a month before use and observed for signs of disease.

- (1) One to two dozen alligators may occupy the same cage.
- (2) These animals are comparatively unaggressive.
- (3) No anesthesia is necessary. Use cold temperature if required.

2. Exposure

a. Caimans or alligators shall be exposed to the lunar sample by the following routes:

- (1) Ingestion of food or drinking water
- (2) Intraperitoneal injection
- (3) Intramuscular injection
- (4) Intracaudal injection

b. The lunar sample shall be suspended in physiological saline.

A one ml injection of the suspension, supernatant, or lunar extract shall be used.

A 22-gauge needle shall be used.

The needle shall be inserted between the scales.

- c. The lunar sample shall be placed in the cage water.
- d. The lunar sample shall be incorporated into the food, shaped into pellets.

### 3. Assessment

#### a. Observations

- (1) The alligator shall be observed for changes deviating from the normal sluggish behavior.
- (2) The alligator shall be watched for morphological changes.
- (3) Metabolic tests shall be performed.
  - (a) Blood - 2 ml of blood shall be withdrawn by cardiac puncture technique without harming the animal.
  - (b) Urine

#### b. Autopsy

#### c. Histology

- (1) Blood smears shall be made. Blood shall be withdrawn by cardiac puncture.
- (2) Smears shall be made of any lesions.

#### d. Secondary culturing

- (1) Lesions shall be cultured for microorganisms according to previously described protocols.
- (2) Blind passages shall be made.

### 4. References

Coulson, R.A. and T. Hernandez, 1964. *Biochemistry of the Alligator*. Louisiana State University Press, Baton Rouge.

Reese, A.M., 1947, *Herpetologica* 4(2): 43.

Reese, A.M., 1915. *The Alligator and its Allies*. G.P. Putnam's Sons, New York, p. 358.

Reichenbach Klinke, H.H. and E. Elkan, 1965. The Principle Diseases of Lower Vertebrates, New York and London Academic Press.

5. Source

Alligators and caimans can be obtained from:

Tarpon Zoo  
Tarpon Springs, Florida 33589

Snake Farm  
La Place, Louisiana 70068

General Biological Supply House (Turtox)  
Chicago, Illinois

## CLASS REPTILIA

## ORDER CHELONIA

Pseudemys scripta elegans (red-eared turtle or terrapin)

The red-eared turtle is a typical fresh-water turtle and represents an ancient reptilian line.

This small hardy turtle is commonly sold as a pet.

1. Maintenance

## a. Equipment

The small turtles shall be kept in an aquarium with fresh water and floating objects for climbing.

A filtration system shall be used whenever necessary.

## b. Feeding

Turtles shall be fed raw ground beef (including heart and liver), meal worms (Tenebrio), and other insects. Commercially prepared dry food may also be used.

2. Exposure

a. The sample shall be incorporated into the food, shaped into pellets.

b. A suspension in physiological saline, filtrate, or an extract of the lunar sample shall be injected into the coelom or muscles.

3. Assessment

Observations shall be made of the normal feeding and behavior of the animal.

4. References

Boycott, B.B. and Robins, M.W., 1961. The care of young red-eared terrapins (Pseudemys scripta elegans) in the laboratory. Br. J. Herpet., 2(12): 206-210.

Reichenbach-Klinke, H.H. and Elkan, E. 1965. The Principle Diseases of Lower Vertebrates, New York and London Academic Press.

5. Source

General Biological Supply House (Turtox).

Locally available.

## CLASS REPTILIA

## ORDER SQUAMATA

## FAMILY IGUANIDAE

Anolis carolinensis (American chameleon)1. Maintenance

## a. Equipment

Small covered terraria or cages shall be used containing a few twigs or branches for climbing.

A cage 2 ft. long and 1 ft. wide will easily accomodate 4 lizards.

A bottle with a drip tube or a small dish must be available for drinking water.

## b. Feeding

The chameleon shall be fed mealworms (Tenebrio) and other live insects, and earthworms.

## c. Lighting and Temperature

No special conditions are required.

## d. Handling

The chameleon is easily handled, and bites are innocuous.

2. Exposure

a. The sample shall be added to the drinking water.

b. The sample shall be incorporated into the food as by injection of larvae.

c. A suspension, filtrate, or extract of the lunar sample shall be injected into the coelom or soft body parts (muscle).

3. Assessment

a. The normal behavior and feeding shall be observed. The male has a distensible dewlap or throat-fan.

b. The ability to change color shall be used as an indication of health. The normal chameleon exhibits a rapid color change.

#### 4. References

The UFAW Handbook on the care and management of laboratory animals.  
3rd Ed., 1967, The Williams and Wilkins Company, Baltimore.

Reinchenback-Klinke, H.H. and Elkan, E., 1965, The Principle Diseases  
of Lower Vertebrates, New York and London Academic Press.

#### 5. Sources

Locally available.

Carolina Biological Supply Co.

General Biological Supply House (Turtux).



## CLASS REPTILIA

## ORDER SQUAMATA

## FAMILY COLLEBRIDAE

Heterodon platyrhinos (hog-nosed snake)1. Maintenance

## a. Equipment

The animals shall be maintained in terraria or cages. The top shall be covered with perforated zinc.

Cages should contain a rough, heavy object as a brick for rubbing against during moulting.

A space 2 ft. long and 1 ft. wide will accommodate two 2-3 ft. long snakes.

## b. Feeding

Snakes shall be fed toads, frogs, or worms.

After eating, snakes should not be handled for 48 hrs.

Healthy snakes may do without food for several months.

A dish of water shall be provided. This should be large enough to allow the animals to immerse themselves.

## c. Temperature

Room temperature.

## d. Lighting

Electric bulbs can be used to simulate sunlight.

## e. Handling

The snake is easily handled. It is non-poisonous. Although it may hiss, strike, and appear dangerous, it will not bite.

The snakes shall be held at least a month before use and observed for signs of disease.

External parasites as mites can be eliminated by washing the entire animal in warm water. The snake shall be dried with cotton wool.

**Anesthesia:**

Barbiturates are preferable to ether and chloroform. See Betz, 1962.

2. Exposure

- a. The sample shall be injected into the food to be ingested.
- b. A suspension in physiological saline, filtrate, or an extract of the lunar sample shall be injected into the coelom.

3. Assessment

The behavior and growth of the snake shall be observed.

4. References

Betz, T.W., 1962. Surgical anaesthesia in reptiles, with special reference to the water snake, Natrix rhombifera. Copeia, 2, 284-287.

Littleford, R.A. and Keiler, W.F., 1946. Observations on captive pilot black snakes and common water snakes. Copeia, 3, 160-167.

Reinchenbach-Klinke, H.H. and Elkan, E., 1965. The Principle Diseases of Lower Vertebrates, New York and London Academic Press.

Smith, H.M., 1953. Snakes as pets. Wisconsin All-Pets Books.

## CLASS REPTILIA

Cell lines

Terrapin-epithelial

Marine turtle-epithelial

1. Maintenance

- a. For information concerning the use of reptilian cell lines, it is recommended that the persons listed in the reference be consulted.
- b. The cultures shall be tested in antibiotic-free media.
- c. Poikilothermic cells shall be tested through the range of their temperature tolerances.

2. Exposure

A suspension or an extract of the lunar sample shall be incorporated into the culture media.

3. Assessment

The effect of the lunar sample on the tissue cultures shall be determined both macroscopically and microscopically.

4. Reference and Source

Dr. H.F. Clark  
Children's Hospital  
219 Bryant Street  
Buffalo, New York 14222

(Terrapin-epithelial)

Dr. G.H. Waddell  
Variety Children's Research Foundation  
P. O. Box 7278  
Miami, Florida 33155

(Marine turtle-epithelial)

## CLASS AVES

Gallus gallus (domestic fowl)

Germ-free embryonated hen's eggs shall be used.

1. Maintenance

- a. Eggs shall be obtained on the day that they are laid (0 day).
- b. Eggs shall be candled to determine viability before inoculation.
- c. Eggs shall be incubated stationary at 25°C and 35°C until a week after the controls have hatched.

2. Exposure

Both sterilized and untreated lunar sample shall be used.

## Inoculation:

Controls shall be inoculated with suspending fluid.

- a. 0.1 ml/egg of a suspension, filtrate, or extract of the lunar sample shall be used for each of the routes.
- b. A minimum of 6 experimental eggs and 6 controls for each variable shall be used.

The following route of inoculation and incubation shall be used:

<u>Route</u>	<u>Embryo Age</u>
Undifferentiated egg yolk	0 days
Amniotic sac	10 - 11 days
Allantoic sac	10 - 11 days
Chorioallantoic membrane	10 - 12 days
Yolk sac	5 - 7 days

3. Assessment

## a. Observation

- (1) Death of eggs shall be detected visually by candling embryonated

eggs during the course of incubation. The blood vessels retract and congeal and the embryo does not move every 10-15 seconds as do healthy embryos.

(2) Pocks

Pocks can be observed macroscopically.

(3) Hatched chicks

These shall be compared with controls for signs of disease or metabolic disfunction.

b. Harvesting

(1) Eggs

Inoculated eggs which have not developed shall be harvested by chilling at 40°C for at least 4 hours. The shell shall then be opened and samples of allantoic fluids, amniotic fluids, yolk sac, chorio-allantoic membrane, and embryo shall be taken for additional inoculation.

(a) Allantoic fluid

This shall be aspirated from the allantoic cavity through a trephined section with a pipette.

(b) Amniotic fluid

The fluid shall be aspirated from the amniotic sac with a pipette.

(c) Yolk sac

The yolk sac shall be collected by suction with a pipette.

(d) Chorioallantoic membrane

The membrane shall be removed surgically and placed in a mortar and ground with alundun and a pestle (or placed in a

Waring Blendor). The homogenized membrane shall be taken up in a diluent (veal-infusion broth) for use in further passage (blind) or for hemagglutination tests.

(2) Chicks

- (a) Chicks which show abnormal symptoms shall be sacrificed.
- (b) Attempts to isolate microorganisms or viruses shall be performed according to the previously described protocols.

c. Blind Passage

Blind passage in animals and eggs shall also be performed.

d. Identification

- (1) Organisms isolated from eggs and/or chicks shall be identified according to previously described procedures.
- (2) Microscopic techniques shall be employed. Both light and electron microscopes shall be used.

4. Source

Eggs can be obtained from Texas A&M, College Station, Texas.

## CLASS AVES (Cont.)

Gallus gallus (domestic fowl)

## Juvenile

1. Maintenance

## a. Equipment

Standard brooding cages shall be used.

## b. Feeding

Commercially prepared chick starter mash or crumbs shall be used.

Drip bottles or a drinking-trough shall be available at all times.

## c. Temperature

The temperature shall be maintained at about 32°C.

2. Exposure

a. A suspension or extract of the sample shall be added to the drinking water.

b. The sample in solid form shall be incorporated into the food.

c. A suspension, filtrate, or extract of the sample shall be injected intraperitoneally, or intramuscularly.

3. Assessment

a. The development and growth rate of the chicks shall be observed.

b. Any chick showing abnormal signs shall be sacrificed and attempts shall be made to isolate replicating organisms. This shall be done by culturing, blind passage in animals and eggs, and microscopic techniques.

4. Reference

The UFAW Handbook on the Care and Management of Laboratory Animals, 1967. 3rd Ed. The Williams and Wilkins Co., Baltimore.

Sturkie, Paul D., 1965. Avian Physiology, 2nd Ed. Comstock Publishing Associates, Ithaca, New York.

## CLASS AVES

Coturnix coturnix (coturnix quail)

The short cycle of this bird makes it an excellent species for quarantine testing. The incubation period is 16-17 days. Sexual maturity takes place 6 to 7 weeks after hatching.

1. Maintenance

## a. Equipment

- (1) Standard individual poultry cages shall be used for adult quail.
- (2) Intermediate-stage growing batteries for poultry shall be used as colony cages for adults. Colony units of 18 females and 6 males can be maintained in a 2' X 2-1/4' floor area.
- (3) Cages with low ceilings or a cloth buffer beneath the wire top of the cage shall be used to eliminate injury (scalping) in an attempt to fly. Cage height ideally should be no greater than 6", however, cages for domestic chicks are usually 12".

## b. Feeding

- (1) Food and water shall be available at all times. Turkey starter crumbles or commercial game rations shall be used.
- (2) For germ-free work, a semi-solid diet with agar and water shall be used to eliminate waste and dust.

## c. Lighting

- (1) Recommended daily photo period of 10L 14D to 20L 4D.
- (2) The duration of daylight affects egg production. Long days stimulate egg laying and shortened day length inhibits laying. A day length of 14 hours is preferred for sustained egg laying.

## d. Incubation

- (1) The average weight of the eggs is 9 grams.



- (2) Eggs shall be stored at 10-15°C at 80-90% humidity.
  - (3) Commercial incubators with modified trays for game bird eggs shall be used.
  - (4) The temperature shall be 37.2-37.8°C in forced-air incubators. The temperature in static-air incubator shall be 38.9-39.4°C. Humidity shall be 60-75%.
  - (5) Eggs shall be turned several times a day by manual or mechanical turners.
  - (6) Incubation time is 16-17 days. Near the end of this period the eggs should receive a light spray of water several times a day to prevent drying of membranes.
- e. Brooding
- (1) The brooding period is of 4-week duration. Chick starter batteries shall be used as brooders the first week after hatching.
  - (2) After the first week, wire floors are desirable.
  - (3) An initial temperature of 35°C is preferred. The temperature shall be gradually decreased at 2-3°C per week until the chicks are fully feathered.
  - (4) Continuous lighting is required.

## 2. Exposure

The adult quail shall be exposed to the lunar sample as follows:

- (a) The lunar sample shall be added into the drinking water.
- (b) The lunar sample shall be incorporated into the food.
- (c) A suspension in physiological saline, filtrate, or extract of the lunar sample shall be injected into the quail.

Injection shall be by the following routes:

Air sac, intraperitoneal, and intracerebral

### 3. Assessment

- (a) The activity of the adult quail shall be observed.
- (b) Fertilized eggs laid by exposed females shall be incubated and the percent hatching shall be determined.
- (c) Some eggs shall be sacrificed for embryological studies.
- (d) The morphology and development of the offspring shall be observed.

### 4. References

Howes, J.R. and Ivey, W.D., 1961. Coturnix quail for avian research. *Feedstuffs*, Minneapolis 33, 21, 38-39.

Padgett, C.S. and Ivey, W.D., 1959. Coturnix quail as a laboratory research animal. *Science* 129, 267-268.

Padgett, C.S. and Ivey, W.D., 1960. The normal embryology of the coturnix quail. *Ana. Rec.*, 137, 1-11.

Reyniers, J.A. and Sacksteder, M.R., 1960. Raising Japanese quail under germ-free and conventional conditions and their use in cancer research. *J. Natl. Cancer Inst.*, 24, 1405-1421.

Wilson, W.O., Abbott, U.K., and Abplanalp, H., 1961. Evaluation of coturnix (Japanese quail) as pilot animal for poultry. *Poultry Science*, 40, 651-657.

The UFAW Handbook on the Care and Management of Laboratory Animals, 3rd Ed., 1967. The Williams & Wilkin's Co., Baltimore.

Quail Quarterly, A Newsletter for Biomedical Research Workers,

J. R. Howes, Editor.

### 5. Source

Department of Poultry Science

Auburn University

Auburn, Alabama

University of California, at Davis.

## CLASS MAMMALIA

Mus musculus (Mouse)

Cavia porcellus (Guinea pig)

I. Subjects

- a. All animals shall be pathogen-free. In addition, germ-free animals shall be used.

Due to space limitations in the lunar receiving laboratory, only one or two species of mammals (mice, guinea pigs, or hamsters) shall be used for primary challenge. If a suspected lunar organism is isolated, however, its potential hazard must be assessed against other mammals. If the presence of pathogens is suspected after an initial testing of 1 or 2 species, then tests shall be extended to include non-human primates. For that reason, an extended preference list is provided.

- (1) Mouse (newborn & adult)
- (2) Guinea pig
- (3) Hamsters (newborn & adult)
- (4) Monkey (newborn & juvenile)
- (5) Rabbit
- (6) Rat
- (7) Ferret
- (8) Swine
- (9) Cat
- (10) Dog

- b. It has been recommended that serious consideration be given to the use of volunteers in evaluating possible effects on man of lunar material. This can only be done after adequate safety tests in animals to insure

permissible levels of various forms of toxicity of the material. Methodology of the experiments would be designed at the time of the test.

2. Maintenance

Instructions for animal maintenance will be found in the reference.

3. Exposure

a. Animals shall be bled prior to inoculation, during the incubation, and at the end of the experiment. Newborn animals shall not be bled.

- (1) Small animals shall be bled from the heart (adult mice, guinea pigs, adult hamsters, rats, rabbits, cats, ferrets).
- (2) Larger animals on the preference list shall be bled as follows: dogs from the cephalic vein and swine from the ear vein or heart.
- (3) It is preferable to separate blood into plasma and rbc and store both.

b. Mammals shall be challenged by one or all of the following routes:

(1) Ingestion

A suspension, sediment, or an extract of the lunar sample shall be added to the food.

(2) Injection

The following routes of injection shall be used:

(a) Mice

The preferential routes of inoculation for mice which shall be used are:

- 1) Intracerebral, i.c.
- 2) Intraperitoneal, i.p.
- 3) Intravenous, i.v.
- 4) Intranasal, i.n.
- 5) Intracutaneous, i.cut.
- 6) Subcutaneous, s.c.
- 7) Oral

## (b) Other Animals

If animals other than mice are used, the preferential routes of inoculation for each are:

- 1) Guinea pig - intraperitoneal, intratesticularly
- 2) Hamsters - intraperitoneal, intravenous
- 3) Monkeys - intravenous
- 4) Rabbit - intracutaneous
- 5) Ferrets - intranasal

c. The size of inocula which shall be used are as follows:

<u>Animal</u>	<u>Baseline Blood Sample (ml)</u>	I.C.	<u>Size of Inoculum* (ml)</u>			
			I.P.	I.M.	I.V.	I-CUT I.N.
<b>Mouse</b>						
Newborn		0.02	0.05	0.05		
Adult	0.1	0.03	0.1	0.1	0.5-1.0	
Guinea Pig	0.5	0.05	1-5	0.2		0.1
<b>Hamsters</b>						
Newborn		0.03	0.05	0.05		
Adult	0.2	0.05	0.2 (1-5)	0.02	1-5	
<b>Monkeys</b>						
Newborn		0.5	2-5	1-3		
Juvenile	0.5	1.0	3-10	1-5		
Rabbit	5.0	0.1	3-5	1-2		
Rat	0.5	0.05	1-2	0.2		
Ferret	5.0	0.1	1-5	1-3		0.2
Swine	20.0	1.0	5-15	2-10		
Cat	5.0	0.5	1-5	1-3		
Dog	10.0	0.5	1-10*	1-3		

\* Variations in volumes of inoculum are based on size of animal.

d. Method

(1) Amount of Sample

Ten grams of prime sample shall be used. Five grams shall be held in reserve; five grams shall be tested.

(2) Sample Preparation

(a) Sample shall be ground if it is not particulate.

(b) Five grams of sample shall be suspended in 30 ml of sterile physiological saline.

1) Stir vigorously for 5 minutes.

2) Allow to settle for 30 minutes.

(3) Animal inoculation

(a) Mice - two groups of four males each shall be used.

1) One set shall be injected intraperitoneally with 1 ml each of the supernatant.

2) The second set shall be inoculated intraperitoneally with 1 ml each of the sediment.

3) All mice shall be held 2 weeks and then sacrificed.

(b) Guinea pigs - two groups of two males each shall be used.

1) One pair shall be injected intratesticularly with 0.5 ml of the supernatant, held 2 weeks for observation and then sacrificed.

2) The second pair shall be injected intratesticularly with 0.5 ml of the sediment, held 2 weeks for observation and then sacrificed.

4. Assessment

a. Macroscopic

Animals shall be observed frequently for symptoms of illness.

b. Microscopic

- (1) Tissues taken from sick animals and used for blind passage shall be examined for organisms under the electron microscope.
- (2) Tissue shall be fixed in 10% formalin and processed for histological study.
- (3) Sections shall be stained with H and E, PAS Gridley modification and Gomori's methenamine silver stains.

c. Secondary passage

- (1) Blind passage of animal materials shall be made. The brain, liver, lungs, kidneys, and samples of muscle tissue, shall be homogenized (individually) and inoculated into the same animal species using the same routes (and volumes of inoculum) as initially.

These may also be combined using 10% suspension of vital organs from I.V. or I.P. injected animals.

- (2) Pieces of liver, spleen, and lung shall be cultured on tubes of Sabouraud dextrose agar, brain-heart infusion agar with 6% blood, and other appropriate media. Two tubes for each organ shall be used.
- (3) Culture tubes shall be incubated at 25°C and 35°C and examined periodically for signs of growth. Tubes shall be held for 2 weeks before being discarded as negative.
- (4) All organisms that develop shall be subcultured, studied microscopically, and inoculated into test animals.

Both light and electron microscopes shall be used.

5. Reference

The UFAW Handbook on the Care and Management of Laboratory Animals, 1967. 3rd Ed., Williams and Wilkins Co., Baltimore.

6. Source

Charles River Breeding Laboratories, Inc.  
Wilmington, Massachusetts 01887



EFFECT OF LUNAR SAMPLE ON WHOLE PLANTS  
(BACTERIA, FUNGI, ALGAE, HIGHER PLANTS)

TREATMENT

PRIMARY OBSERVATION

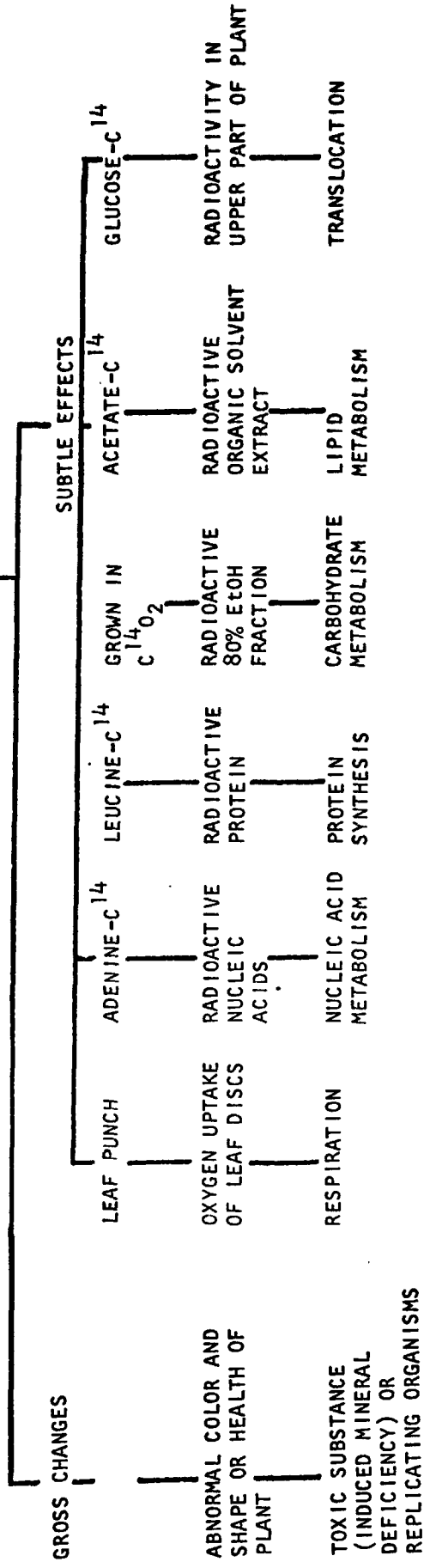

ADDITIONAL TREATMENT

OBSERVATION

TEST

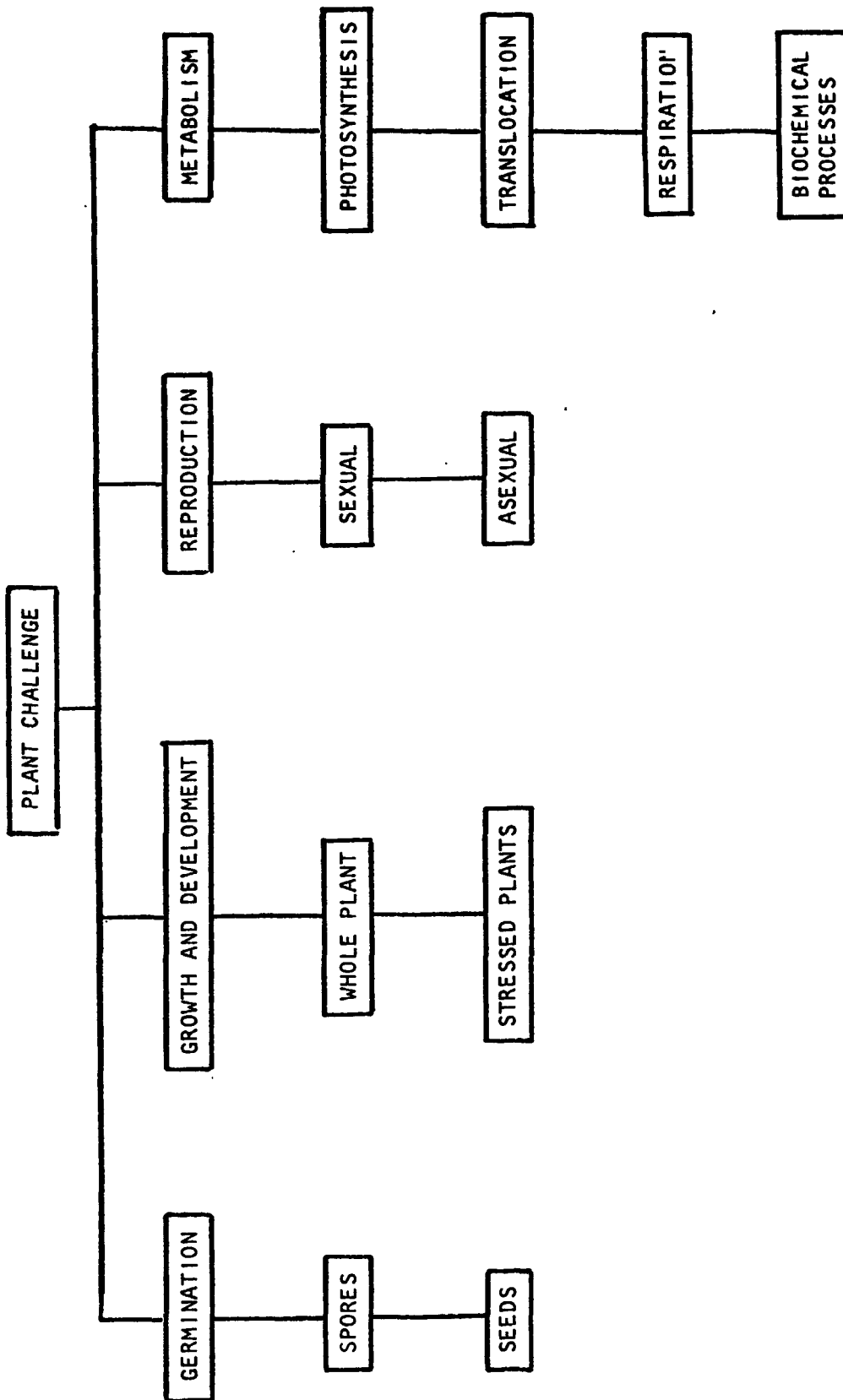

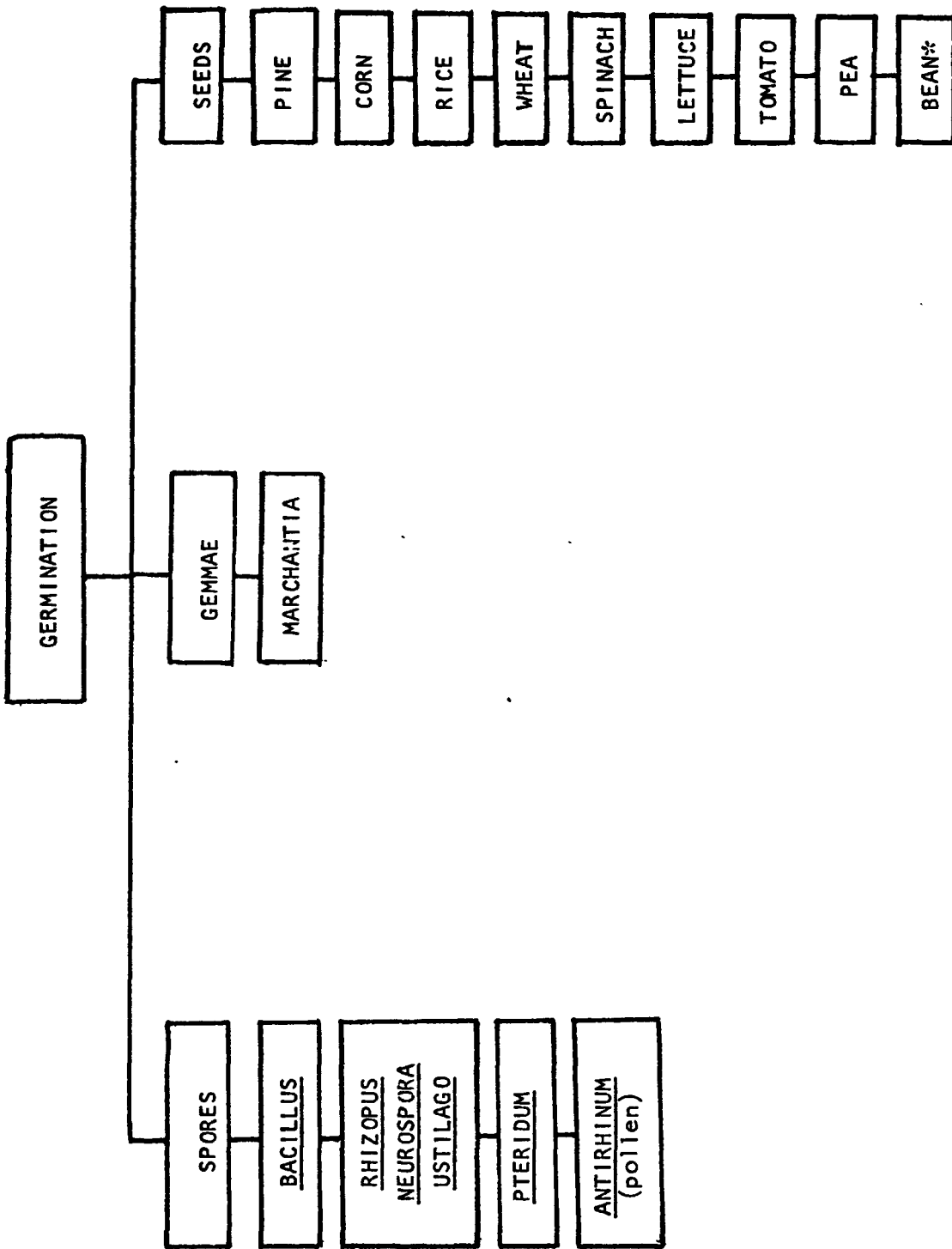

\*for soy bean

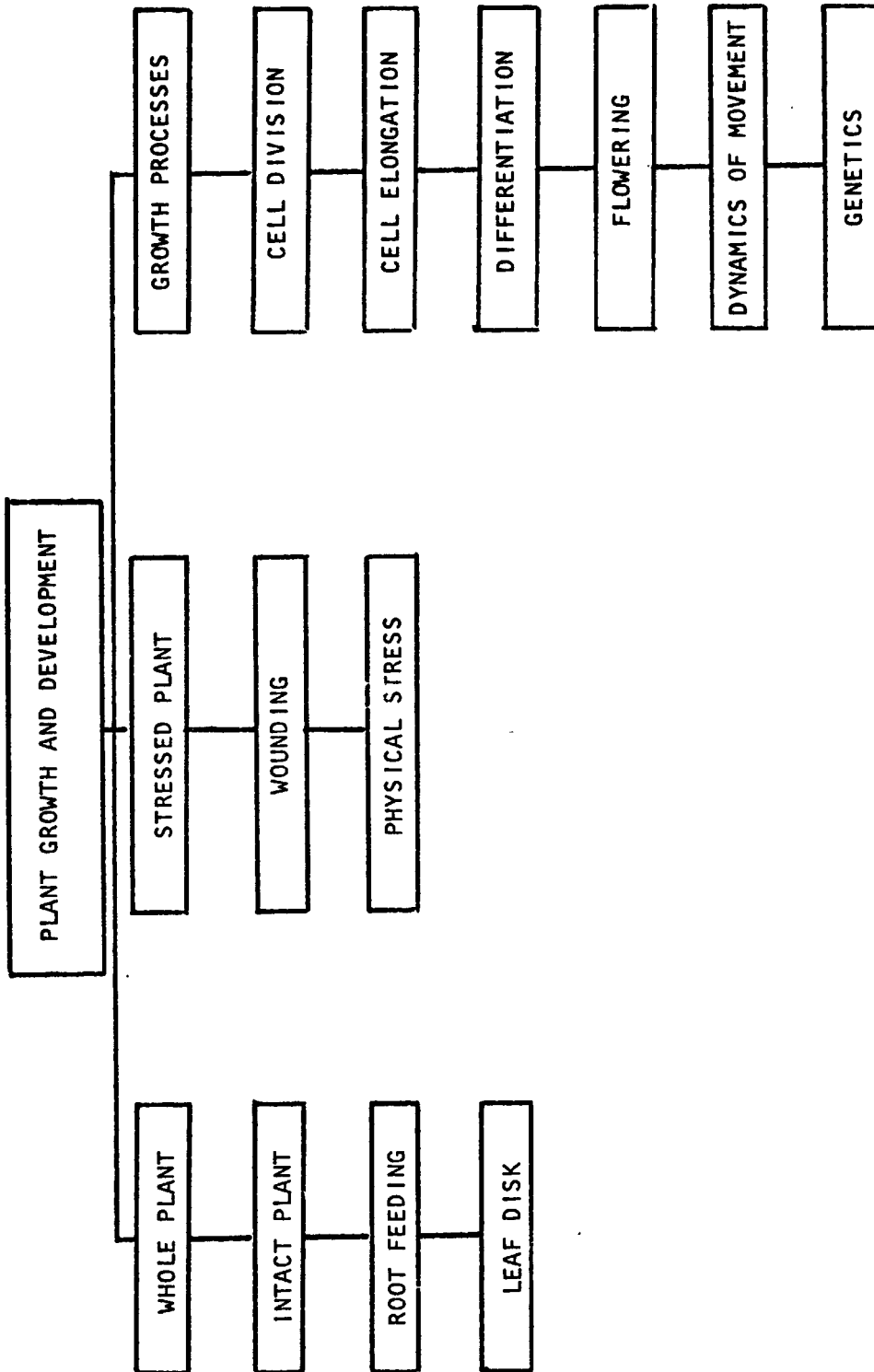

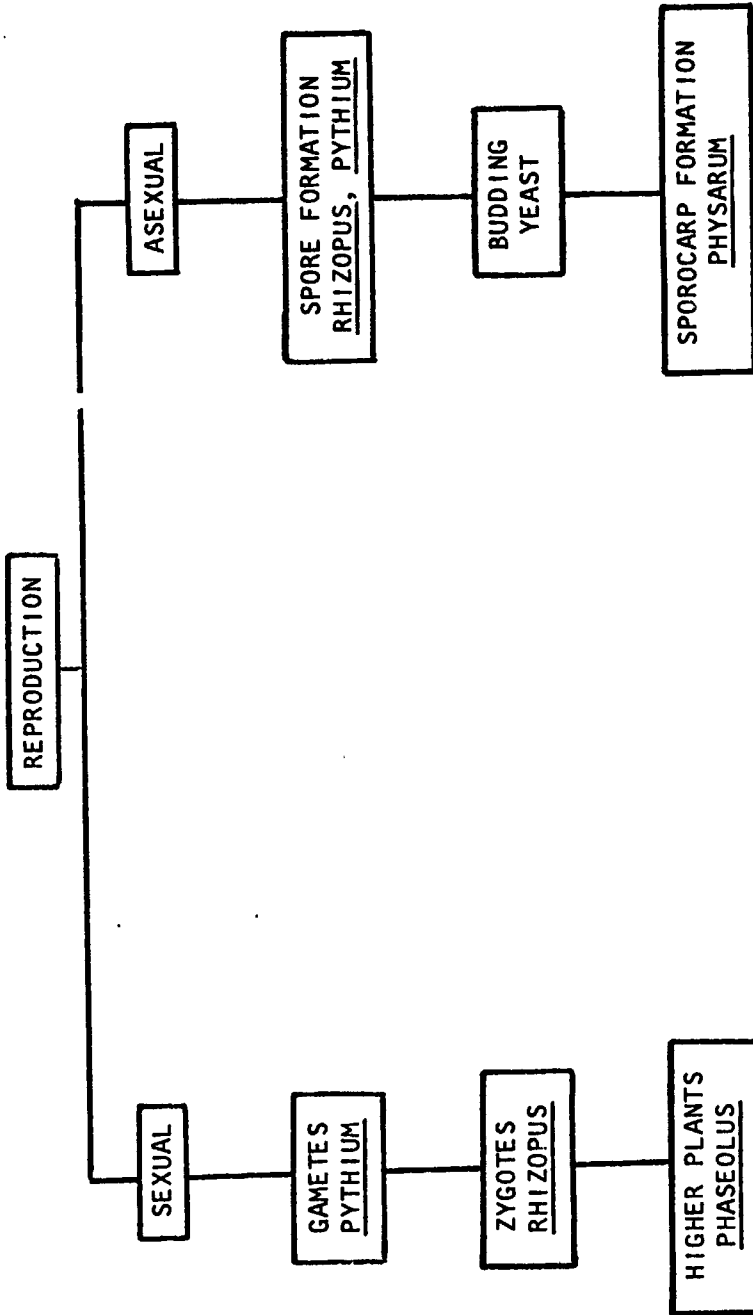



EFFECTS OF LUNAR SAMPLE ON CELL CULTURE  
(Chlorella)

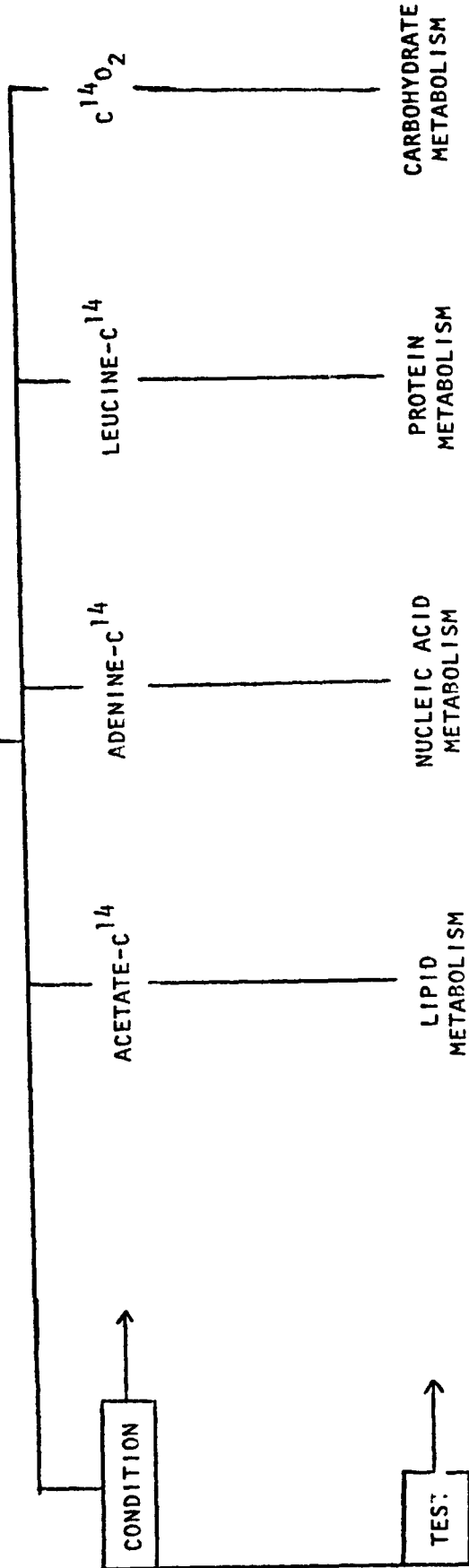

PLANT SCHEMA  
PRIORITY TESTING

Division Protophyta

Schizomycetes

Escherichia coli (bacterium)

Division Chlorophyta

Chlorophyceae

Chlorella (green alga)

Division Mycophyta

Phycomycetes

Rhizopus nigricans (fungus)

or

Ascomycetes

Neurospora crassa (fungus)

Division Tracheophyta

Gymnospermae

Pinus palustris (pine)

Angiospermae

Triticum vulgare (wheat) (Monocotyledon)

Phaseolus vulgaris (bean) (Dicotyledon)



PLANT SCHEMA

ADDITIONAL SPECIES OF HIGH PRIORITY

Division Tracheophyta

Angiospermae

Nicotiana tabacum (tobacco-tissue culture)

Vicia faba (broad bean)

GENERAL STATEMENT

Plants shall be exposed to the lunar sample using the procedures described in the following pages.

1. In all instances, whether specifically cited or not, the first assessment will be to determine if there are any changes in the general condition of the plant, a lack of well being, or death.

If such an alteration occurs, then the cause must be determined.

The change can be due to:

- a. Natural causes not related to sample exposure.
  - b. A chemical reaction to the sample.
  - c. Diseased state caused by a replicating organism within the sample.
2. If such gross change does not occur, then the assessment shall be made according to the specific procedure given to determine what subtle effect, if any, the lunar sample has on the normal biology of the organism in question.
  3. In all tests the experimentals shall be compared to the controls.
  4. If an alteration in the general condition of the exposed plant appears to be due to a replicating organism, a pathogenicity test shall be performed as follows:
    - a. Isolation of the causal agent in pure culture and/or transfer to another living host if it is an obligate parasite.
    - b. Reinoculation of the causal agent into the same species.
    - c. Similar symptoms should appear in the host as originally observed.
    - d. The same causal agent should be reisolated.

### GENERAL ISOLATION PROCEDURE

If abnormal symptoms appear on plants treated with the lunar sample, the following procedure shall be followed to determine if the effect is due to a replicating organism:

1. The abnormal part of the plant and associated parts shall be surface disinfected by treatment with 0.5% sodium hypochlorite for ten minutes.
2. The plant part shall then be washed with sterile water and placed on a suitable growth medium. All forceps, needles, and scalpels shall be sterilized by dipping in 70% alcohol and flaming the instrument.
3. Any organisms that develop shall be cultured and eventually isolated in pure culture.
4. The pure culture shall be reinoculated into the same host plant and observed for the development of similar symptoms as observed in the original plant.
5. The same organism should be reisolated from infected plant.
6. An organism shall be considered a plant pathogen if all of the previous conditions are fulfilled.

### References

Riker, A.J. and R.S. Riker, 1936. Introduction to Research on Plant Diseases. John S. Swift Co., Inc., Chicago, Illinois.

Hansen, H.N., 1926. A simple method of obtaining single spore cultures. Science, 64: 384.

Johnson, L.F., E.A. Curl, J.H. Bond, and H.A. Fribourg, 1959. Methods for Studying Soil Microflora. Burgess Publishing Co., Minneapolis, Minn.

### ISOLATION PROCEDURE FOR VIRAL ORGANISMS

If the abnormal symptoms on plants exposed to the lunar sample are caused by an obligate parasite such as a virus, the normal isolation procedure will fail to detect the causal agent. The pathogen cannot be cultured without a living host. The following procedure shall be followed to determine if the symptoms are due to a replicating organism.

1. The abnormal plant shall be grafted to a normal plant using aseptic procedures to prevent any introduction of additional pathogens.
2. The grafted plants shall be incubated in a high-moisture environment to encourage the graft union.
3. Observations shall be made to determine if similar symptoms appear in the second plant that are comparable to those of the original plant.
4. Additional tests shall be made to determine if the causal agent can be transmitted mechanically, such as by rubbing ground plant material on the plant.
5. Tests shall be conducted to determine the characteristics of the viral agent. The physical and chemical properties shall be determined by electron microscopy and serological studies.

#### References

- Corbett, M.R. and H.D. Sisler, 1964. Plant Virology. University of Florida Press, Gainesville, Florida.
- Rawlins, R.E. and W.N. Takahashi, 1952. Technics of Plant Histochemistry and Virology. The National Press, Millbrae, California.
- Bawden, F.C., 1950. Plant Viruses and Virus Diseases. Chronica Botanica Waltham, Mass.

## DIVISION PROTOPHYTA

## CLASS SCHIZOMYCETES

## ORDER EUBACTERIALES

Bacillus subtilisBacillus megatherium

## I. GERMINATION

A. Spores1. Methods

- a. Bacillus subtilis or Bacillus megatherium shall be grown aerobically on potato extract medium, Feeney's complete medium, whey agar, or any other sporulation medium.
- b. After the culture has sporulated, the spores shall be harvested, washed, and refrigerated until needed.
- c. The spores shall be heat shocked for 30 minutes at 60°C before use.

2. Exposure

- a. The lunar sample or 1 ml of a suitable suspension shall be added to 2.5 ml of a spore suspension.
- b. The lunar sample and spore suspension shall be streaked on suitable media or added to 20 ml of broth in an Erlenmeyer flask (0.5 ml/plate, 1.0 ml/flask).

(1) Feeney's Complete Medium\*

(2) Whey agar

The culture shall be incubated aerobically at 25° or 35°C.

3. Assessment

The effect of the lunar sample on germination shall be determined

---

\* See appendix for reference and formula.

by comparing the percent germination of the treated cultures with the untreated controls. Plate count methods (as described for Escherichia coli) shall be used in this assessment.

4. Source

American Type Culture Collection.

## DIVISION PROTOPHYTA

## CLASS SCHIZOMYCETES

## ORDER EUBACTERIALES

Escherichia coli (bacteria)

## I. GROWTH PROCESSES

A. Growth rate1. Methods

- a. A suspension containing a known number of cells shall be cultured in a medium containing the lunar sample.
- b. A suspension containing a known number of cells shall be exposed to the lunar sample, washed, and subcultured.
- c. All cells shall be grown in shake cultures at 25° or 35°C for 24 hours. Erlenmeyer flasks containing 25 ml of nutrient or Penassay broth shall be used.

2. Assessment

Growth rate shall be measured by determining the increase in cell numbers/unit time.

## a. Turbidity

Increase in turbidity shall be measured hourly using a photometer.

## b. Cell count

Samples (1 ml) shall be removed hourly from the flask, suitably diluted, and plated. Increases in cell count/unit time as well as total counts shall be obtained. The effect of the lunar sample on the growth rate shall be obtained by comparing the cells exposed to the lunar sample with the untreated controls.

## B. Genetic Change: Biochemical Mutants

Genetic changes in microorganisms are reflected by changes in metabolic pathways. The ability of the lunar sample to produce mutations shall be determined using an organism with known genetic background. Forward mutations suitable for screening for any type of mutagenesis shall be determined. These shall include:

- a. Mutation to Streptomycin resistant-E. coli B or K-12
- b. Mutation to T1 phage resistant - E. coli B
- c. Mutation to valine resistant - E. coli K-12

### 1. Methods

- a. A suspension of E. coli K-12 or B shall be cultured at 35°C in a medium containing the lunar sample.
- b. An established culture of E. coli shall be exposed to the lunar sample, washed, and cultured at 35°C.

### 2. Assessment

Subsequent generations shall be observed for heritable changes.

If any evidence of mutagenesis is detected, the specific type of mutagenesis that is being induced shall be determined by using suitable autotrophs and selecting for "revertants." A suitable choice of autotrophs would be some of the tryptophaneless mutants of E. coli of Dr. Yanofsky of Stanford University, Palo Alto, California. The frequency of "reversion" of such mutants shall be determined by plating on minimal medium. The "revertants" shall be checked to determine which amino acid substitutions have occurred. By deduction from our knowledge of the genetic code, one can usually infer which nucleotide pair changes have occurred.



### References

Hayes, W., 1964. The Genetics of Bacteria and their Viruses. J. Wiley & Sons, Inc., New York.

Jukes, T.H., 1966. Molecules and Evolution. Columbia University Press, New York.

Example of use of reverse mutations to determine the mechanism of mutagenesis.

Yanofsky, C.A., 1965. Biochem. Biophys. Res. Comm., 18, 898.

Yanofsky, C.A., Cox, E. and Horn, V., 1966. Proc. Natl. Acad. Sci., 55, 274.

## II. METABOLISM

### A. Protein Metabolism

1. Cultures shall be grown at 25°C in Erlenmeyer flasks containing 50 ml of Medium "C" and the lunar sample. Medium "C" is given in the Appendix.
2. Leucine-C<sup>14</sup> (1 µc) shall be added to the shake cultures.
3. Cultures shall be harvested 24 hours later. The reaction shall be stopped by adding 10 ml of 10% trichloroacetic acid. The mixture shall be centrifuged at 10,000 g and the supernatant decanted. The residue shall be mixed with 5 ml of 10% TCA and centrifuged. This process shall be repeated three times.
4. The residue after the final centrifugation shall be suspended in 10 ml of liquid scintillation solution (2,5-diphenyloxazole and p-bis-2 (5-phenyloxazole) benzene at a ratio of 20:1 in p-dioxane) containing thixotropic gel to suspend the residue.
5. The amount of radioactivity in the protein material shall be determined in a liquid scintillation spectrometer.
6. The effect of the lunar sample on the incorporation of leucine-C<sup>14</sup>

into protein shall be determined by comparison of the cells exposed to lunar sample with the untreated control.

### References

Bray, G.H., 1960. A simple efficient liquid scintillator for counting aqueous solutions in a liquid scintillation counter. *Anal. Biochem.* 1: 279-282.

Lowry, O.H., H.J. Rosebrough, A.L. Farr, and R.J. Randal, 1951. Protein measurements with the folin phenol reagent. *J. Biol. Chem.* 193: 265-275.

Siegel, M.R. and H.D. Sisler, 1964. Site of action of cycloheximide in cells of Saccharomyces pastorianus. II. The nature of inhibition of protein synthesis in a cell-free system. *Biochim. Biophys. Acta* 87: 83-89.

Wisseman, G.L., J.E. Smadel, F.E. Hahn, and H.E. Hopps, 1954. Mode of action of chloroamphenicol. I. Action of chloroamphenicol on assimilation of ammonia and on synthesis of proteins and nucleic acids in Escherichia coli. *J. Bacteriol.* 65: 662-673.

Wang, C.H. and D.L. Willis, 1965. *Radiotracer Methodology in Biological Science*. Prentice Hall, Englewood Cliff, N.J.

### B. Nucleic Acid Metabolism

1. Shake cultures shall be grown at 25°C in Erlenmeyer flasks (250 ml) containing 50 ml of medium and the lunar sample.
2. 1  $\mu$ c of adenosine-C<sup>14</sup> shall be added to the shake cultures.
3. The cultures shall be harvested after 24 hours and the nucleic acids removed by the following method:
  - a. The cultures shall be chilled to 8°C and one volume of 10% chilled perchloric acid added. This mixture shall be centrifuged at 10,000 x g and the supernatant discarded. The procedure shall be repeated.

- b. The residue shall be treated with 10 ml of ethanol and the mixture centrifuged at 10,000 g. This process shall be repeated twice with the residue followed by a final treatment using ethanol and ether (1:1).
  - c. The residue that is free from lipid material and soluble phosphate compounds shall be dried and stored.
  - d. 100 mg of the dried material shall be added to 5 ml of 5% perchloric acid and heated for 15 minutes. The mixture shall be centrifuged at 10,000 x g and the process repeated. Each time, the supernatant (which contains the nucleic acids) shall be collected.
4. The supernatant (from 3 d) shall be assayed for absorption at 260 m $\mu$  in a spectrophotometer.
  5. The amount of radioactivity in the supernatant shall be determined by adding one ml of the material to 10 ml of the dioxane liquid scintillation solution. The solutions shall be counted in a liquid scintillation spectrometer.
  6. The amount of deoxyribonucleic acid shall be determined using 1 ml of the hot perchloric acid extract and adding 2 ml of the diphenylamine reagent. After heating the mixture for 10 minutes in a boiling water bath, the solution shall be read at 600 m $\mu$  in a spectrophotometer.
  7. The ribonucleic acid content shall be determined by digesting the dried residue (100 mg of sample) in 10 ml of 1 N KOH overnight at 37°C. The ribose content shall then be determined by the orcinol test.
  8. The effect of the lunar sample on nucleic acid metabolism shall be determined by comparing the cultures exposed to lunar sample with the untreated control.

### References

De Deken-Grenson, M. and R.H. De Deken, 1959. Elimination of substances interfering with nucleic acids estimation. *Biochim. Biophys. Acta* 31: 194-208.

Schneider, W.C., 1957. Determination of nucleic acids in tissues by pentose analysis, p.680-684. In S.P. Colowick and N.O. Kaplan (ed) *Methods in Enzymology III*. Academic Press Inc., New York.

### C. Lipid Metabolism

1. Shake cultures shall be grown at 25°C in 250 ml Erlenmeyer flasks containing 50 ml of medium and the lunar sample.
2. One  $\mu\text{c}$  of acetate-C<sup>14</sup> shall be added to the shake cultures.
3. The cultures shall be harvested after 24 hours. The lipids shall be extracted by adding 25 ml of Chloroform-methanol (3:1) to the cultures. The extraction shall be repeated three times with an intervening centrifugation at 10,000 g each time. The supernatants from the three extractions shall be combined to represent the total lipid fraction.
4. The radioactivity in the lipid fraction shall be determined by adding 1 ml of the lipid fraction to 10 ml of liquid scintillation solution (POP and POPOP in toluene. See part II, A, 4. ).
5. If necessary, the lipid fraction shall be further fractionated by applying the sample to a silicic acid column and eluting with different non-polar solvents (hexane, benzene or chloroform). Gas chromatography shall then be used to separate the individual compounds.

### References

Desty, D.H. and A. Goldup, 1960. In R.P.W. Scott (ed.) *Gas Chromatography*. Butterworths, London.

Deuel, Jr., H.J., 1951. *The Lipids, Their Chemistry and Biochemistry*. Interscience, N.Y.

Stumpf, P.K., 1960. Lipid metabolism. *Ann. Rev. Biochem.* 29, 261.

#### D. Carbohydrate Metabolism

1. Shake cultures shall be grown at 25°C in 250 ml Erlenmeyer flasks containing 50 ml of medium and the lunar sample.
2. One  $\mu\text{c}$  glucose- $\text{C}^{14}$  shall be added to the shake flasks. The flasks shall be capped with a large rubber serum stopper. A small plastic cup with a handle shall be extended through the stopper. The cup shall contain 0.1 ml of phenethylamine solution which will trap any  $\text{CO}_2$  given off by the respiring cells.
3. The  $\text{CO}_2$  collected in the phenethylamine shall be assayed for radioactivity in the liquid scintillation spectrometer.

#### References

- Arnoff, S., 1961. Techniques of Radiobiochemistry. Iowa State Univ., Ames.
- Greenberg, D.M., 1960. Metabolic Pathways. Academic Press, N.Y.
- Pigman, W., 1957. The Carbohydrates. Academic Press, N.Y.
- Rapkin, E., 1962. Measurement of  $\text{C}^{14}\text{O}_2$  by scintillation techniques. Packard Tech. Bull. 7: 1962.

## DIVISION PROTOPHYTA

## CLASS SCHIZOMYCETES

## ORDER PSEUDOMONADALES

Chlorobium thiosulfatophilum (green sulfur bacteria) or Chlorobium limacola

## PHOTOSYNTHESIS

These organisms are capable of anaerobic photosynthesis in the presence of  $H_2S$  and light. They do not liberate oxygen but oxidize  $H_2S$  to elemental sulfur.

1. Methods

- a. Shake cultures shall be grown anaerobically on Larsen's medium\* containing  $H_2S$ ,  $2 \mu c$  of  $C^{14}O_2$  and lunar sample.
- b. They shall be grown in the presence of light at  $25^\circ C$ .
- c. The length of exposure shall be 30 minutes.
- d. The cells shall be poured into boiling alcohol to stop the reaction.

2. Assessment

- a. The alcohol extract shall be analyzed by radioautography to determine the radioactive sugars (see procedure for Chlorella).
- b. The effect of the lunar sample on photosynthesis shall be measured by comparing the amount of  $C^{14}O_2$  incorporated into carbohydrate of the treated cells compared to the untreated controls.

3. Reference

\*Larsen, H. 1952. On the culture and general physiology of the green sulfur bacteria. J. Bact. 64: 187.

## DIVISION PROTOPHYTA

## CLASS SCHIZOMYCETES

## ORDER PSEUDOMONADALES

Rhodospirillum rubrum (purple bacteria)

## PHOTOSYNTHESIS

These organisms are capable of anaerobic photosynthesis when grown on media containing  $\text{CO}_2$  and a wide variety of organic compounds in the presence of light.

1. Methods

- a. Shake cultures shall be grown anaerobically in a medium containing a wide variety of organic compounds, growth factors, and the lunar sample.
- b. They shall be grown in the light at  $25^\circ\text{C}$ .
- c.  $2 \mu\text{C}^{14}\text{O}_2$  shall be added to the flasks.
- d. The length of exposure to  $\text{C}^{14}\text{O}_2$  shall be 30 minutes.
- e. The cells shall be poured into boiling alcohol to stop the reaction.

2. Assessment

- a. The alcohol extract shall be analyzed by radioautography to determine the radioactive sugars (see procedures for Chlorella).
- b. The effect of the lunar sample on photosynthesis shall be measured by comparing the amount of  $\text{C}^{14}\text{O}_2$  incorporated into carbohydrate of the treated cells compared to the untreated controls.

3. References

Van Niel, 1944. The culture, physiology, morphology, and classification of the non-sulfur purple and brown bacteria. Bact. Rev. 8: 1.

## DIVISION PROTOPHYTA

## CLASS SCHIZOMYCETES

## ORDER EUBACTERIALES

Azotobacter vinlandii (nitrogen-fixing bacteria)

## I. METABOLISM

A. Nitrogen fixation1. Methods

Shake cultures shall be grown at 25°C in Burk's nitrogen-free mineral salts medium containing the lunar sample.

2. Assessment

Growth rate shall be measured by determining the increase in cell numbers/unit time. This indicates the degree of N<sub>2</sub> fixation.

## a. Turbidity

Increase in turbidity shall be measured at 4, 8, 12, 16, and 24 hours using a photometer.

## b. Cell count

Samples (1 ml) shall be removed at 2, 4, 8, 12, 16, and 24 hours from the flask, suitably diluted, and plated. Increases in cell count/unit time as well as total counts shall be obtained. The effect of the lunar sample on the growth rate shall be obtained by comparing the cells exposed to the lunar sample with the untreated controls.

3. References

Burk, D. and H. Lineweaver, 1930. J. Bacteriol. 19: 389-414.



## DIVISION CYANOPHYTA

## CLASS CYANOPHYCEAE

Anacystis nidulans (blue-green algae)

## I. GROWTH AND DEVELOPMENT

## A. Culture

1. Maintenance

- a. A high-temperature strain is recommended.
- b. Information on the culturing of Anacystis is given in the reference, Kratz and Myers, 1955.

2. Exposure

A suspension or an extract of the lunar sample shall be added to the culture medium.

3. Assessment

The effect of the lunar sample on the growth of a culture of Anacystis shall be determined.

4. Reference

Benoit. 1960. Selection of an algae for a photosynthetic gas exchanger. Wright Air Development Division. Tech. Report 60-163. Office of Technical Services, U.S. Department of Commerce.

Kratz, W.A. and J. Myers, 1955. Nutrition and growth of several blue-green algae. Amer. J. Bot. 42: 282-287.

5. Source

Strain I U 625 may be obtained from:

Dr. Richar Starr  
Culture Collection of Algae  
Department of Botany  
University of Indiana  
Bloomington, Indiana

## DIVISION CHLOROPHYTA

## CLASS CHLOROPHYCEAE

## ORDER CHLOROCCALES

Chlorella (green algae)

## I. METABOLISM

A. Photosynthesis1. Methods

Shake cultures shall be used. The lunar sample shall be incorporated into the culture medium (Chlorella medium). Cultures shall be grown at 25°C in the light.

## a. The path of carbon

- (1) The incorporation of  $C^{14}O_2$  into carbohydrates by photosynthesis shall be studied.
- (2) Organisms shall be exposed to  $C^{14}O_2$  in a flattened separatory funnel in the presence of light.
- (3) The length of exposure to  $C^{14}O_2$  shall be 10 minutes and the concentration shall be 2  $\mu$ c.
- (4) The cells shall be poured into boiling alcohol to stop the reaction.
- (5) The alcohol extract shall be analyzed by radioautography to determine the radioactive sugars (see references).

## b. Photosynthetic rate\*

- (1) The rate of photosynthesis shall be determined using a Warburg respirometer or oxygen electrodes.
- (2) The rate of oxygen evolved as compared to the amount of carbon dioxide taken up by exposed cells shall be determined.

---

\* If the incorporation of  $C^{14}O_2$  into carbohydrate is determined, Warburg studies are superfluous.

## 2. Assessment

Experimental and control cultures shall be compared to determine the effect of the lunar sample on photosynthesis.

## 3. References

Bassham, J.A. and M. Calvin, 1957. The Path of Carbon in Photosynthesis. Prentice Hall, Englewood Cliffs, N.J.

Bonner, J. and J.E. Varner, 1965. Plant Biochemistry. Academic Press, N.Y.

## B. Protein Metabolism

1. Cultures shall be grown at 25°C in the presence of light in Erlenmeyer flasks containing 50 ml of Chlorella medium containing the lunar sample.
2. Leucine-C<sup>14</sup> (1 µc) shall be added to these shake cultures.
3. Cultures shall be harvested 24 hours later. The reaction shall be stopped by adding 10 ml of 10% trichloroacetic acid. The mixture shall be centrifuged at 10,000 g and the supernatant decanted. The residue shall be mixed with 5 ml of 10% TCA and centrifuged. This process shall be repeated three times.
4. The residue after the final centrifugation shall be suspended in 10 ml of liquid scintillation solution (2,5-diphenyloxazole) benzene at a ratio of 20:1 in p-dioxane) containing thixotropic gel to suspend the residue.
5. The amount of radioactivity in the protein material shall be determined in a liquid scintillation spectrometer.
6. The effect of the lunar sample on the incorporation of leucine-C<sup>14</sup> into protein shall be determined by comparison of the cells exposed to lunar sample with the untreated control.

### References

Bray, G.H., 1960. A simple efficient liquid scintillator for counting aqueous solutions in a liquid scintillation counter. *Anal. Biochem.* 1: 279-282.

Lowry, O.H., H.J. Rosebrough, A.L. Farr, and R.J. Randal, 1951. Protein measurements with the folin phenol reagent. *J. Biol. Chem.* 193: 265-275.

Siegel, M.R. and H.D. Sisler, 1964. Site of action of cycloheximide in cells of Saccharomyces pastorianus. II. The nature of inhibition of protein synthesis in a cell-free system. *Biochim. Biophys. Acta* 87: 83-89.

Wang, C.H. and D.L. Willis, 1965. *Radiotracer Methodology in Biological Science*. Prentice Hall, Englewood Cliffs, N.J.

Wissemann, G.L., J.E. Smadel, F.E. Hahn, and H.E. Hopps, 1954. Mode of action of chloroamphenicol. I. Action of chloroamphenicol on assimilation of ammonia and on synthesis of proteins and nucleic acids in Escherichia coli. *J. Bacteriol.* 65: 662-673.

### C. Nucleic Acid Metabolism

1. Shake cultures shall be grown at 25°C in Erlenmeyer flasks (250 ml) containing 50 ml of medium and the lunar sample.
2. 1  $\mu$ c of adenosine-C<sup>14</sup> shall be added to the shake cultures.
3. The cultures shall be harvested after 24 hours and the nucleic acids removed by the following method:
  - a. The cultures shall be chilled to 8°C and one volume of 10% chilled perchloric acid added. This mixture shall be centrifuged at 10,000 x g and the supernatant discarded. The procedure shall be repeated.
  - b. The residue shall be treated with 10 ml of ethanol and the mixture centrifuged at 10,000 g. This process shall be repeated twice with

the residue followed by a final treatment using ethanol and ether (1:1).

- c. The residue that is free from lipid material and soluble phosphate compounds shall be dried and stored.
  - d. 100 mg of the dried material shall be added to 5 ml of 5% perchloric acid and heated for 15 minutes. The mixture shall be centrifuged at 10,000 x g and the process repeated. Each time the supernatant (which contains the nucleic acids) shall be collected.
4. The supernatant from 3 d shall be assayed for absorption at 260  $\mu$  in a spectrophotometer.
  5. The amount of radioactivity in the supernatant shall be determined by adding one ml of the material to 10 ml of the dioxane liquid scintillation solution. The solutions shall be counted in a liquid scintillation spectrometer.
  6. The amount of deoxyribonucleic acid shall be determined using 1 ml of the hot perchloric acid extract and adding 2 ml of the diphenylamine reagent. After heating the mixture for 10 minutes in a boiling water bath, the solution shall be read at 600  $\mu$  in a spectrophotometer.
  7. The ribonucleic acid content shall be determined by digesting the dried residue (100 mg of sample) in 10 ml of 1 N KOH overnight at 37°C. The ribose content shall then be determined by the orcinol test.
  8. The effect of the lunar sample on nucleic acid metabolism shall be determined by comparing the cultures exposed to lunar sample with the untreated control.

#### References

- De Deken-Grenson, M. and R.H. De Deken, 1959. Elimination of substances interfering with nucleic acids estimation. *Biochim. Biophys. Acta* 31: 194-208.

Schneider, W.C., 1957. Determination of nucleic acids in tissues by pentose analysis, p. 680-684. In S.P. Colowick and N.O. Kaplan (ed.) Methods in enzymology III. Academic Press Inc., New York.

D. Lipid Metabolism

1. Shake cultures shall be grown at 25°C in 250 ml Erlenmeyer flasks containing 50 ml of medium and the lunar sample.
2. One  $\mu\text{c}$  of acetate- $\text{C}^{14}$  shall be added to the shake cultures.
3. The cultures shall be harvested after 24 hours. The lipids shall be extracted by adding 25 ml of Chloroform-methanol (3:1) to the cultures. The extraction shall be repeated three times with an intervening centrifugation at 10,000 g each time. The supernatants from the three extractions shall be combined to represent the total lipid fraction.
4. The radioactivity in the lipid fraction shall be determined by adding 1 ml of the lipid fraction to 10 ml of liquid scintillation solution (POP and POPOP in toluene).
5. If necessary, the lipid fraction shall be further fractionated by applying the sample to a silicic acid column and eluting with different non-polar solvents (hexane, benzene, or chloroform). Gas chromatography shall then be used to separate the individual compounds.

References

Desty, D.H. and A. Goldup, 1960. In R.P.W. Scott (ed.) Gas chromatography. Butterworths, London.

Deuel, Jr., H.J. The lipids, their chemistry and biochemistry. Interscience, N.Y. 1951.

Stumpf, P.K., 1960. Lipid metabolism. Ann. Rev. Biochem. 29:261.

### E. Carbohydrate Metabolism

1. Shake cultures shall be grown at 25°C in 250 ml Erlenmeyer flasks containing 50 ml of medium and the lunar sample.
2. One  $\mu\text{c}$  glucose-C<sup>14</sup> shall be added to the shake flasks. The flasks shall be capped with a large rubber serum stopper. A small plastic cup with a handle shall be extended through the stopper. The cup shall contain 0.1 ml of phenethylamine solution which will trap any CO<sub>2</sub> given off by the respiring cells.
3. The CO<sub>2</sub> collected in the phenethylamine shall be assayed for radioactivity in the liquid scintillation spectrometer.
4. The amount of C<sup>14</sup>O<sub>2</sub> released by the breakdown of glucose-C<sup>14</sup> is a measure of carbohydrate metabolism

### References

- Arnoff, S., 1961. Techniques of radiobiochemistry. Iowa State University, Ames.
- Greenberg, D.M., 1960. Metabolic pathways. Academic Press, N.Y.
- Pigman, W., 1957. The carbohydrates. Academic Press, N.Y.
- Rapkin, E., 1962. Measurement of C<sup>14</sup>O<sub>2</sub> by scintillation techniques. Packard Tech. Bull. 7: 1962.

### Source

A high-temperature strain is recommended: (Original strain T X 71105)  
Strain I U 1230 may be obtained from:

Dr. Richard Starr  
Culture Collection of Algae  
Department of Botany  
University of Indiana  
Bloomington, Indiana

Bacteria-free cultures are available.

## DIVISION EUGLENOPHYTA

## CLASS EUGLENOPHYCEAE

## ORDER EUGLENALES

Euglena gracilis (unicellular algae)

## I. METABOLISM

A. Chlorophyll synthesis1. Methods

- a. Shake cultures of Euglena gracilis shall be grown in the dark for 72 hours at 25°C in the presence of the lunar sample (or extract).\*
- b. Samples of these cultures shall be subjected to 300 foot candles of light.

2. Assessment

- a. Regeneration of chlorophyll shall be observed visually by comparing treated cultures with controls at 12, 18, 24, and 36 hours.
- b. If desired, the amount of chlorophyll shall also be determined by acetone extraction and spectrophotometric analyses.

B. Photosynthesis1. Methods

- a. The rest of the culture (from A, 1, b) shall be grown in the light for 24 hours.
- b. 2  $\mu\text{c}$  of  $\text{C}^{14}\text{O}_2$  shall be added.

---

\*The formula for this medium is given in the section on Animal Challenge.



- c. After 30 minutes, the reaction shall be stopped by pouring the culture into boiling alcohol.

## 2. Assessment

The alcohol extract shall be analyzed by radioautography to determine the radioactive sugars. Experimental and control cultures shall be compared to determine the effects of the lunar sample on photosynthesis.

## 3. References

Animal Challenge section of the protocol, page 155.

Wolken, J.J., 1967. Euglena, an experimental organism for biochemical and biophysical studies. Meredith Publishing Co., New York, New York.

## C. Source

### 1. Information on the culturing of Euglena:

Dr. Seymour Hutner  
Haskins Laboratory  
305 E. 43rd St.  
New York, New York 10017

### 2. Strain 1 U 753 is available from:

Dr. Richard Starr  
Culture Collection of Algae  
Department of Botany  
University of Indiana  
Bloomington, Indiana

Bacteria free cultures are available.

The "Z strain" is recommended.

## DIVISION CHRYSOPHYTA

## CLASS CHRYSOPHYCEAE

## ORDER CHRYSOMONADALES

Ochromonas danica (golden-brown algae)

## I. GROWTH AND DEVELOPMENT

## A. Culture

## 1. Methods

- a. The basic soil-water medium shall be made by placing a small quantity of powdered  $\text{CaCO}_3$  in a test tube and adding 1/4" - 1/2" of garden soil to the tube. The soil should have an average humus content. Soils with a high clay content, or soils that have been recently fertilized with a commercial fertilizer, shall not be used.
- b. Distilled water shall be added until the tube is three-quarters full.
- c. The tubes shall be stoppered with cotton and steamed, not autoclaved, for one hour at  $100^\circ\text{C}$  on two consecutive days.
- d. Tubes shall be allowed to clear by settling before they are inoculated.

2. Exposure

A suspension or an extract of the lunar sample shall be incorporated into the culture medium.

3. Assessment

- a. The growth of the exposed culture shall be observed and compared with the controls.

- b. The activity of Ochromonas shall be studied. It is a particle-ingesting organism.

4. Reference

Bold, H.C., 1957, Morphology of Plants, Harper and Brothers, New York, New York.

Pringsheim, E.G., 1946, Pure Cultures of Algae, Their Preparation and Maintenance, Cambridge University Press, Cambridge, England.

Pringsheim, E.G., 1950, "The Soil-Water Culture Technique for Growing Algae," The Culturing of Algae, a Symposium, Kettering Foundation.

5. Source

Strain I U 1298 may be obtained from:

Dr. Richard Starr  
Culture Collection of Algae  
Department of Botany  
University of Indiana  
Bloomington, Indiana

Bacteria-free cultures are available.

## DIVISION MYXOPHYTA

## CLASS MYXOMYCETES

## ORDER PHYSARALES

Physarum polycephalum (slime mold)

## I. GROWTH PROCESSES

A. Dynamics of movement1. Methods

- a. Sclerotia of Physarum polycephalum shall be germinated in an oatmeal agar medium\* containing the lunar sample.
- b. The growing portion of the plasmodium shall be transferred to a medium containing the lunar sample.

2. Assessment

- a. The newly growing plasmodium shall be examined for its color, consistency, and general structure.
- b. The streaming of the plasmodial protoplast and the reversal of the direction of the streaming shall be observed under the microscope.
- c. Treated and untreated cells shall be compared.

B. Differentiation1. Methods

- a. Physarum polycephalum shall be grown in the presence of the lunar sample.
- b. Differentiation of sporocarps shall be studied.
- c. The slide culture technique shall be used. This technique is given in the appendix.

2. Assessment

- a. The undisturbed relationship between the protoplasm and formation

---

\* The formula for this medium is given in the appendix.

of reproductive and other specialized structures shall be observed microscopically.

b. Treated cultures shall be compared with the untreated controls.

Reference

Alexopoulos, C.J. and E.S. Beneke, 1965. Laboratory Manual for Introductory Mycology, 5: 48-49.

Source

General Biological Supply House (Turtox), Chicago, Ill.

## DIVISION MYCOPHYTA

## CLASS PHYCOMYCETES

## ORDER MUCORALES

Rhizopus nigricans (fungi)

## I. GERMINATION

A. Spores1. Methods

- a. Rhizopus nigricans shall be grown on Fothergill's medium at 25°C for several days.
- b. The spores shall be harvested and washed.
- c. The lunar sample shall be incorporated into a germination solution consisting of 0.01 M proline and 0.1 M phosphate buffer pH 6.5.
- d. The spores shall be germinated for 8 hours in this mixture by:
  - (1) Placing them in a petri plate containing the solution.
  - (2) Placing them on filter paper floated on the surface of the solution.

2. Assessment

The percent germination compared with the untreated controls shall be determined to assess the effect of the lunar sample on this process.

3. References

Weber, D.S. and J.M. Ogawa, 1965. The specificity of Proline in the germination of spores of Rhizopus arrhizus. *Phytopathology*, 55, 262-266.

4. Source

Stock Center for Fungi

USDA Laboratory

Peoria, Illinois

## II. REPRODUCTION

### A. Asexual: conidia formation

#### 1. Methods

- a. An established culture of Rhizopus shall be dusted with the lunar sample, washed, and grown on Fothergill's solid medium.\*
- b. Vegetative cells of Rhizopus shall be grown on Fothergill's solid medium containing the lunar sample.

#### 2. Assessment

The ability of exposed vegetative cells to form spores shall be studied.

### B. Sexual: Zygote formation

#### 1. Methods

- a. A plus strain and a minus strain of Rhizopus treated as indicated above shall be inoculated on Fothergill's solid medium on opposite sides of a petri dish.
- b. The plates shall be incubated at 25°C.
- c. Zygosporangia will form in the area where the mycelia of the two strains have grown together.

#### 2. Assessment

A comparison of the zygosporangia formed from cultures exposed to the lunar sample with those of untreated controls shall indicate the effect of lunar material on zygosporangia formation.

### Reference

Cutter, Jr., V.M., 1942. Bull. Torrey Bot. Club 69: 480-616.

---

\* The formula for this medium is given in the appendix.

## DIVISION MYCOPHYTA

## CLASS PHYCOMYCETES

## ORDER PERONOSPORALES

Pythium debaryanum (water mold)

## I. REPRODUCTION

## A. Asexual

1. Method

- a. The fungus shall be grown on potato dextrose medium (liquid) at 28°C for 2-3 days.
- b. The medium shall be decanted and sterile water added back to the mycelial mat.
- c. The culture shall be chilled at 10-15°C for one hour and then returned to room temperature.
- d. The lunar sample shall be incorporated into the potato dextrose medium.

2. Assessment

- a. Zoospore liberation shall be observed microscopically.
- b. The effect of the lunar sample on zoospore formation, liberation, and swarming shall be determined by comparison with the controls.

B. Sexual1. Method

- a. P. debaryanum shall be grown on potato dextrose agar containing 0.1% glucose instead of 1%.
- b. The lunar sample shall be added to the medium.
- c. Cultures shall be grown at 28°C.
- d. Microscopic observations shall be made daily for the formation of



antheridia, oogonia, and oospore formation.

- e. After the oospores have formed, the cultures shall be chilled for 3 hours at 10-15°C and then returned to room temperature.

## 2. Assessment

Observations shall be made to determine if germ tubes have been formed from the oospores.

The effect of the lunar sample on the formation of antheridia, oogonia, oospores, and germ tubes shall be studied. The experimentals shall be compared to the controls.

## 4. Reference

Fitzpatrick, H.M., 1930. The Lower Fungi-Phycomycetes. McGraw-Hill Book Co., New York.

Middleton, J.T., 1943. The taxonomy, host range and geographical distribution of the genus Pythium. Torrey Bot. Club Mem. 20: 1-171.

Miyake, K., 1901. The fertilization of Pythium debaryanum. Bot. 15-653-667.

## DIVISION MYCOPHYTA

## CLASS ASCOMYCETES

## SUBCLASS EUASCOMYCETES

## ORDER SPHAERIALES

Neurospora crassa (fungi)

## I. GROWTH PROCESSES

A. Growth Rate1. Methods

- a. Neurospora crassa shall be cultured in a medium containing the lunar sample. Vogel's medium shall be used.\*
- b. Cultures shall be exposed to the lunar sample, washed, and sub-cultured.
- c. All cultures shall be grown, without shaking, at 23-25°C. Samples shall be harvested or measured at intervals of 12-24 hours.

2. Assessment

Growth shall be assessed by the following methods:

- a. Increase in weight of fungal mycelial pads/unit time.
- b. Increase in the length of hyphal runners/unit time using race tubes (Ryan, Beadle and Tatum, 1943).
- c. The effect of the lunar sample on the growth rate shall be determined by comparing treated cells with the controls.

B. Genetic Change: biochemical mutants

Genetic changes in microorganisms are primarily reflected in their biochemical patterns.

1. Methods

- a. Neurospora shall be cultured in a medium containing the lunar sample

---

\* The formula for this medium is given in the appendix.

- b. An established culture with known genetic markers such as pigmentation or a nutritional requirement shall be exposed to suspensions of the lunar sample. The pigmented adenine-less strain shall be used.
- c. The exposed colonies shall be subcultured.

## 2. Assessment

Subsequent generations shall be observed for any heritable changes in these markers. For example, the loss of pigmentation in the purple adenine-less strain of Neurospora indicates mutations which have blocked the earlier steps in the formation of pigment precursors.

## Reference

Ryan, F.J., G.W. Beadle and E.L. Tatum, 1943. Am. J. Bot. 30: 784-799.

## Source

Dr. Ray Barrat  
Neurospora Stock Center  
Department of Biology  
Dartmouth College  
Hanover, New Hampshire

## CLASS ASCOMYCETES

## SUBCLASS HEMIASCOMYCETES

## ORDER ENDOMYCETALES

Saccharomyces cerevisiae (yeast)

## I. REPRODUCTION

A. Asexual: budding1. Method

- a. An established culture of yeast shall be dusted or suspended in a solution containing the lunar sample on Sabouraud's medium at 25°C. The cells shall be washed and cultured.
- b. Yeast cells shall be cultured in media containing the lunar sample.

2. Assessment

The ability of exposed cells to undergo cell division (budding) shall be studied.

3. Reference

Hashimoto, T., S.F. Conti, and H.B. Naylor, 1959. Studies of the fine structure of microorganisms. IV. Observations on budding Saccharomyces cerevisiae by light and electron microscopy. Jr. Bact., 77: 344-354.

4. Source

Stock Center for Fungi, United States Department of Agriculture Laboratory, Peoria, Illinois.

## DIVISION MYCOPHYTA

## CLASS BASIDIOMYCETES

## ORDER UREDINALES

## FAMILY SEPTOBASIDIACEAE

Ustilago maydis (corn smut)

## I. GERMINATION

A. Spores1. Method

- a. The spores of Ustilago maydis shall be suspended in a germination solution consisting of H<sub>2</sub>O and glucose 10<sup>-2</sup> M.
- b. The lunar sample shall be incorporated into the medium.
- c. The spores shall be incubated in the germination medium at 25°C.

2. Assessment

The percent germination of the experimentals shall be determined and compared with that of the controls.

3. Reference

Kernkamp, M.F. and M.A. Petty, 1941. Variation in the germination of chlamydospores of Ustilago zaeae. *Phytopathology* 31: 333-340.

4. Source

United States Department of Agriculture Laboratories,  
Washington State University.

## DIVISION BRYOPHYTA

## CLASS HEPATICAE

## ORDER MARCHANTIALES

Marchantia polymorpha (liverwort)

## I. GERMINATION

A. Asexual1. Methods

- a. Gemma cups containing large numbers of gemmae shall be excised from stock plants growing in environmental chambers. The gemmae shall be harvested from the gemma cups.
- b. They shall be surface-sterilized and rinsed in sterilizing fluids.
- c. The gemmae shall be plated onto filter paper over agar media in petri plates.
- d. The lunar sample shall be dusted on the surface of the gemmae.
- e. The cultures shall be maintained in a controlled environmental chamber.
- f. Cultures shall be maintained at 23-25°C with 18 hour illumination (1,000 foot candles).

2. Assessment

- a. Growth of the gemmae shall be observed one week after plating using a dissecting microscope.
- b. The survival rate of exposed gemmae shall be determined after two weeks of growth.

The survival, number, and location of apical and other outgrowths shall be compared with that of the controls.

3. Reference

Miller, M.W., A.H. Sparrow and A.. Rogers, 1965. The radiosensitivity of gemmae of Marchantia polymorpha to acute gamma radiation. The Bryologist 68: 31-47.

4. Source

Professor Paul D. Voth of University of Chicago, Chicago.

Turttox Biological Supply House, Chicago.

## DIVISION TRACHEOPHYTA

## SUBDIVISION PTEROPSIDA

## CLASS FILICINEAE

## ORDER FILICALES

Pteridium aqualinum (fern)

## I. GERMINATION

A. Spores1. Methods

- a. Spores shall be surface-sterilized in 5% calcium hypochlorite for 2-3 minutes in a centrifuge tube.
- b. The spores shall be washed in a millipore filter apparatus by suctioning and washing 3-4 times with sterile water.
- c. The surface-sterilized spores shall be transferred to a known quantity of distilled water.
- d. A spore count shall be made.
- e. Spores shall then be inoculated in culture media containing the lunar sample. Solid media in petri plates or test tube slants shall be used.
- f. A medicine dropper shall be used to inoculate the spores.
- g. Cultures shall be maintained at 25°C with 12 hour illumination (white light).
- h. As an alternate procedure, surface-sterilized spores shall be dusted with lunar sample for varying periods of time (2, 4, and 12 hours) and then inoculated into culture media as detailed above.
- i. Four to 5 days after inoculation, the spores will germinate and will be visible as green patches.

2. Assessment

- a. The percent germination and condition of the exposed sporelings shall be compared to the controls. This assessment shall be made periodically.



- b. The nature of sporeling growth shall be measured by photographic methods.
- c. A cell count in the sporelings shall be made.
- d. The length/width ratio shall also be observed.

### 3. Reference

Steeves, T. A., I. M. Sussex and C. R. Partanen, 1955. In vitro studies on abnormal growth of prothalli of the bracken fern, Amer. J. Bot. 42: 232-245.

### 4. Source

Turtox, General Biological Supply House, Chicago.

## II. REPRODUCTIVE STAGES

### A. Formation of sex organs

#### 1. Methods

Pteridium aquilinum shall be grown in media containing the lunar sample.

#### 2. Assessment

- a. Sporelings shall be fixed in acetic-alcohol for 1-24 hours, washed in water 2-3 times, and stained in Delafield's Haematoxylin for 2 hours.
- b. They shall be washed and destained in a watchglass containing acid-alcohol (95% alcohol containing a few drops of 1 N HCl) for 5-10 minutes, depending on the original stain. The sporelings will appear slightly red.
- c. Sporelings shall be transferred to petri plates containing distilled water and a few drops of hydrogen peroxide for 5 minutes.
- d. Prothalli shall be examined microscopically. They will appear white or slightly purple, but the nuclei will be stained. If sex organs have formed, they can be observed by their characteristic appearance.

If sperm have formed in the antheridia, they will be seen as curled structures within the antheridium.

## CLASS GYMNOSPERMAE

## SUBCLASS CONIFEROPHYTAE

## ORDER CONIFERALES

## FAMILY PINACEAE

Pinus palustris (long leaf pine)

## I. GERMINATION

A. Seeds1. Methods

## a. Exposure

- (1) Pine seeds from which the seedcoats have been removed shall be surface-sterilized in 5% calcium hypochlorite for 5 minutes and then washed in distilled water 2-3 times.
- (2) The surface-sterilized seeds shall be soaked in an aqueous suspension of the lunar material for 1, 2, 4, 8 and 12 hours.

## b. Growth

- (1) The exposed seeds shall be grown in petri plates with filter paper and sterile water, OR they shall be grown in test tubes containing White's nutrient agar medium.
- (2) After germination, seeds shall be transferred to a peat-moss soil mixture for further observations.
- (3) The material shall be grown at 23-25°C.
- (4) A 18 hour light cycle shall be maintained.

## c. Germination time

If the seed coats have been removed, germination will take place within 15-20 days.

2. Assessment

- a. The percent germination of exposed seeds shall be compared to the controls.

b. Growth observations shall be made at intervals.

3. Source

United States Department of Agriculture government laboratories and nurseries.

II. METABOLISM

A. Translocation: Water and food materials

1. Methods

- a. 15-30 day old pine seedlings shall be used for translocation studies.
- b. The lunar sample shall be incorporated into the translocation solution which shall contain  $C^{14}$ -sucrose and a few drops of dye.
- c. Both intact plants and plants which have been cut under water shall be placed in the translocation solution for 6 and 12 hours.

2. Assessment

- a. Intact plants which have been placed in the solution shall be observed for wilting.
- b. After a period of time, the upper part of the plants shall be assayed for radioactivity by the following procedure:
  - (1) The plants shall be pressed between two filter papers for 1-2 days at warm temperatures.
  - (2) The pressed plants shall be placed on Kodak X-ray film in the dark room and left for 1, 2, and 3 weeks.
  - (3) At appropriate intervals, the X-ray film shall be developed to observe if radioactivity appears on the apical region of the plant.
  - (4) Radioautograms of exposed plants shall be compared with the controls to assess the effect of the lunar sample.

## CLASS ANGIOSPERMAE

## SUBCLASS MONOCOTYLEDONAE

## ORDER LILIALES

## FAMILY LILIACEAE

Allium cepa (onion)

## GROWTH PROCESSES

A. Cell division1. Methods

- a. Bulbs of Allium cepa shall be grown in a glass container with the bottom portion of the plant dipping into water or a nutrient solution. Any liquid tissue culture medium that does not contain sugar may be used.
- b. The solution shall be changed every day.
- c. After 3-4 days, the roots will begin to grow. Actively growing roots and lateral roots shall be immersed in a beaker containing the lunar sample and incubated for 12-24 hours.
- d. The root tips shall be removed at intervals of 2, 4, 8, 12, and 24 hours.
- e. Standard squash techniques and staining shall be employed. Once the root tips are readily growing, the squash procedure (after incubating in test solutions) does not take more than 10 minutes.
- f. The root apices shall be fixed in acetic alcohol (95% ethyl alcohol 3 parts: Glacial acetic acid 1 part) for 1-2-24 hours.
- g. Washed root tips shall be hydrolyzed in a vial containing 1 N HCl in a 60°C oven. The HCl shall be poured off.

h. The roots shall be washed and stained with acetic orcein or Feulgen for 10-15 minutes.

i. Slides shall be made permanent by the normal dry-ice technique.

2. Assessment

a. Slides shall be examined microscopically.

b. Squashed cell preparations shall be examined for stages of nuclear division.

c. Mitotic rate shall be analyzed, and the rate of mitosis determined.

d. The effect of the lunar sample on the sites of continuous meristematic activity in plants shall be determined by comparison with the controls.

B. Genetic change: chromosomal aberration

The chromosomes of the onion are morphologically distinct. The diploid number is 14-16.

1. Methods

a. Procedures shall be followed as outlined in the above section on cell division.

b. A higher concentration of lunar sample shall be added to the liquid medium in which the root tips are exposed.

c. Slides shall be made of squash preparations using acetocarmine or Feulgen stains.

2. Assessment

If the lunar material has mutagenic effects, various types of chromosome aberrations will be discernible. The slides shall be examined microscopically for the following:

a. Loss of segment of a chromosome (deletion).

b. Addition of chromosomal segment (duplication).

c. Interchromosomal rearrangement by exchange of segments (translocation).

- d. Interchromosomal rearrangement by rotation of a segment 180 degrees, reversing the gene order (inversion).
- e. Variation in chromosome number leading to haploidy, polyploidy, aneuploidy (monosomic, polysomic, or nullisomic).
- f. Endopolyploidy or polyteny.
- g. Nature of mitotic spindle, and, if abnormal, how affected.
- h. Effect on centriole.
- i. Nature of spindle movement to the poles.
- j. These shall be compared with C-mitosis produced by colchicine.

#### References

- Jensen, W.A., 1962. Botanical histochemistry. W.H. Freeman & Co. pp. 95-98.
- DeRobertis, E.D.P., W.W. Nowinski, and F.A. Saez, 1965. Cell Biology. W.B. Saunders Co., pp. 253-271.

#### Source

United States Department of Agriculture.

## CLASS ANGIOSPERMAE

## SUBCLASS MONOCOTYLEDONAE

## ORDER GRAMINALES

## FAMILY GRAMINAE

Zea mays (corn)

## I. GERMINATION

A. Seeds1. Methods

## a. Exposure

- (1) Surface-sterilized seeds shall be dusted with lunar material.
- (2) Surface-sterilized seeds shall be soaked in an aqueous suspension of lunar material.

## b. Growth

- (1) The exposed seeds shall be germinated in moist filter paper.
- (2) The seeds shall be grown in filter paper or polyethylene beads in petri dishes and sterile water.
- (3) A 12-hour light cycle shall be maintained.
- (4) Germination time shall be 4-5 days.

2. Assessment

- a. Analysis shall be made of the percent germination compared with the controls.
- b. The condition of the seedlings shall be observed.

3. Source

United States Department of Agriculture.



## II. GROWTH PROCESSES

Genetic Change--Biochemical Mutants1. Methods

- a. Normal and variety dwarf d-1 seeds of Zea mays shall be soaked for 12-24 hours in water containing the lunar sample.
- b. The seeds shall be planted in polyethylene flats and grown in a growth chamber for 7-10 days.
- c. The temperature shall be 25° C.
- d. A 16-hour photoperiod shall be maintained.
- e. At the end of the 7-10 day period, one-half of the dwarfs and one-half of the normal seedlings shall be treated with one drop of gibberellin solution (1,000 ppm in ethanol).

2. Assessment

- a. The morphological characteristics shall be observed.
- b. Measurements shall be made of the height of the plant.

3. Reference

Lockhart, J.A., 1962. Light and hormones in plant development.  
AIBS Publication of Symp. on Teaching Developmental Botany, p. 26.

4. Source

Asgrowseed Co., New Haven 2, Connecticut.  
United States Department of Agriculture.

CLASS ANGIOSPERMAE

SUBCLASS MONOCOTYLEDONAE

ORDER GRAMINALES

FAMILY GRAMINAE

Triticum vulgare (wheat)

GERMINATION

1. Methods

The exposure and germination of wheat shall follow the procedures as described for Zea mays.

2. Assessment

The percent germination and condition of the germinated seedling shall be determined. This shall be compared with that of the controls.

3. Source

United States Department of Agriculture

CLASS ANGIOSPERMAE

SUBCLASS MONOCOTYLEDONAE

ORDER GRAMINALES

FAMILY GRAMINAE

Oryza sativa (rice)

GERMINATION

Seeds

1. Methods

The exposure and germination of rice shall follow the procedure as described for Zea mays.

2. Assessment

The percent germination and condition of germinated seedling shall be determined. This shall be compared with that of the controls.

3. Source

United States Department of Agriculture.

## CLASS ANGIOSPERMAE

## SUBCLASS MONOCOTYLEDONAE

## ORDER GRAMINALES

## FAMILY GRAMINAE

Avena sativa (var. victory oats)

## GROWTH AND DEVELOPMENT

A. Cell elongation and differentiation

The coleoptile region of young seedlings is very sensitive to external factors which affect cell elongation.

1. Methods

- a. Husked oats (victory variety) shall be placed in water. Husking reduces the germination time.
- b. Seeds shall be soaked in water for 2 hours and the soak-water discarded.
- c. The seeds shall be placed with their embryo side projecting slightly over the edge of glass plates covered with wet filter paper. Alternately, the seeds shall be planted in a plastic container holding wet polyethylene beads.
- d. The containers with the seeds shall be placed in a dark germination chamber at 15°C. The seeds shall be kept moist.
- e. One day after planting, the seeds shall be exposed to two hours of red light to inhibit elongation of the first internode.
- f. Three days after planting the coleoptiles should be 20-30 mm long, and one 10 mm section shall be cut. The apical 4 mm of the coleoptile shall be discarded. Preferably only 2 sections shall be taken from one coleoptile. The primary leaf of the plant coming through the

coleoptile shall be removed.

The sections shall be placed directly into petri dishes containing the lunar sample in a 10 ml solution of 2% sucrose solution, pH 5.5. Varying concentrations of the lunar sample shall be used. The sections shall be immersed at all times.

2. Assessment

- a. After exposure to the lunar sample the sections shall be measured for cell elongation at 6-hour intervals.
- b. Photographic methods shall be used to record the degree of elongation.
- c. The growth rate shall be determined and compared to the controls.

B. Effect of plant auxins

1. Methods

Various auxins shall be included in some of the plates containing the lunar sample used in the cell elongation studies above. The following auxins shall be used at concentrations ranging from  $1 \times 10^{-4}$  to  $1 \times 10^{-7}$  M:

- a. IAA = Indoleacetic acid.
- b. NAA =  $\alpha$ -naphthalene acetic acid.
- c. 2, 4-D = 2, 4-dichlorophenoxyacetic acid.
- d. GA = Gibberellic acid
- e. Kin. = Kinetin

2. Assessment

- a. The sections shall be measured after 48 hours of exposure to the lunar sample and auxins.

- b. The effect of auxin on the coleoptiles exposed to the lunar sample shall be determined.
- c. Cell elongation in the presence of auxin shall be observed by microscopic examination and photographic methods.
- d. The sections shall be measured at intervals and the growth rate determined.

Data shall be reported as percent of control or increase in elongation.

Reference

Leopold, A.C., 1960. Auxins and plant growth. University of California Press, Los Angeles.

Source

United States Department of Agriculture.

## CLASS ANGIOSPERMAE

## SUBCLASS DICOTYLEDONAE

## ORDER CHENOPODIACEAE

Spinacea oleracea (spinach)

## GERMINATION

Seeds1. Methods

- a. Surface sterilized seeds shall be dusted or soaked in an aqueous suspension of lunar material.
- b. The seeds shall be germinated and grown on filter paper or in petri dishes containing polyethylene beads in distilled water.
- c. The temperature shall be 23-25°C.
- d. A 12 hr light cycle shall be used.

2. Assessment

- a. The percent germination shall be determined and compared to the controls.
- b. The condition of the germinated seeds shall be observed.

3. Source

United States Department of Agriculture.

## CLASS ANGIOSPERMAE

## SUBCLASS DICOTYLEDONAE

## ORDER ROSALES

## FAMILY LEGUMINACEAE

Phaseolus vulgaris (bean)

## I. GERMINATION

Seeds1. Methods

- a. Surface-sterilized seeds shall be dusted or soaked in an aqueous suspension of lunar material.
- b. The seeds shall then be germinated and grown on filter paper or in petri plates containing polyethylene bead in distilled water.
- c. The temperature shall be 23-25°C.
- d. A 12-hour light cycle shall be used.
- e. Germination time shall be 5-8 days.

2. Assessment

- a. The percent germination shall be determined and compared to the controls.
- b. The condition of the germinated seeds shall be observed.

## II. GROWTH AND DEVELOPMENT

A. Normal intact plant (whole plant)

Seedlings from surface-sterilized seeds that have grown in a gnotobiotic environment shall be used.

1. Maintenance

- a. Growth chambers shall be used and a gnotobiotic environment shall be maintained.



- b. Plants shall be grown in individual plastic pots (3" x 2" x 4") that have holes at the bottom. Polyethylene beads are recommended as a root support. A white quartz sand-pearlite medium or vermiculite may also be used.
- c. Plants shall be watered with Hoagland's solution.
- d. A temperature of  $\pm 25^{\circ}\text{C}$  shall be maintained. The chamber must have an adequate air-conditioning system to handle the heat produced by the lighting system.
- e. A 18 LD photoperiod shall be used. There shall be between 1100-2100 foot-candles of light at plant level inside of the growth chamber. This shall be provided by the high intensity fluorescent tubes and 110 watt incandescent bulbs in a 3:1 ratio.
- f. 50% humidity shall be maintained.

## 2. Exposure

The growing points, leaves, stems, and roots shall be exposed to the lunar sample.

- a. An aqueous solution of the lunar sample shall be applied to plants by using a medicine dropper.
- b. The lunar sample in powder form shall be applied to plants in a settling chamber.
- c. Plants shall be grown in Hoagland's nutrient solution containing the lunar sample (root drenching method).

## 3. Assessment

- a. Gross observations shall be made of all treated systems. Height,

color, root, and top appearance shall be observed.

b. Observations shall be made for the following morphological changes:

- (1) Epinasty (wilting)
- (2) Necrotic spots
- (3) Chlorotic leaves
- (4) Abnormal swellings (root swellings or tumorous growth)

c. The following data shall be obtained:

- (1) Amount of roots
- (2) Dry weight of seedling

d. Sections shall be made, stained and observed microscopically. The roots and vascular system shall be examined in detail.

Cytological stains:

- (1) Safranin - Fast green double stain.
- (2) Phloroglucinol-HCl

B. Normal intact plant (half leaf)

This test shall be used to determine local toxicity. It allows a comparison of the treated and the blank on the same leaf. It also allows a comparison with a non-treated leaf.

i. Methods

- a. A plant not previously exposed to the lunar sample shall be used for the tests.
- b. Two paired leaves shall be selected.
- c. One half of one leaf shall be treated with a solution containing the lunar sample.
- d. The other half of this leaf shall be treated with a blank solution only.

e. The second leaf of the pair shall remain untreated and shall act as

a control.

2. Assessment

Observations shall be made for any abnormalities, wilting, necrotic or chlorotic spots.

C. Stressed plants

Plants that are stressed may be more susceptible to a toxic agent contained in the lunar sample.

1. Methods used to stress plants

a. Wounding

The lunar sample shall be applied to the plant during or immediately after wounding.

(1) The leaves shall be rubbed to cause an abrasion. The lunar sample shall serve as an abrasive.

(2) The leaves shall be brushed with cotton swabs or a stiff brush causing the trichomes to break. The sample shall be applied to the injured surface.

b. Change in the physical environment (temperature extremes)

(1) Plants shall be exposed to the lunar sample by the root drench method.

(2) One half of the plants shall be held at 4°C and the other half at 35°C.

(3) Plants previously exposed by the root drench method and held at normal temperatures shall serve as additional controls.

2. Assessment

a. Gross observations shall be made of the following: height, color, root and top appearance.

- b. Any morphological changes or abnormalities shall be noted.
- c. The dry weight of the seedling shall be obtained.
- d. The stressed exposed plants shall be compared with the controls.

### III. REPRODUCTION

#### A. Sexual

A variety of bean with a 15-20 day cycle shall be used.

##### 1. Method

- a. The lunar sample shall be applied to plants in the reproductive stage by the dust or drenching method.
- b. The seeds shall be harvested and air dried for 10-15 minutes.
- c. Seed viability shall be tested by germination on moistened filter paper.
- d. The seeds shall be planted using methods previously described.

##### 2. Assessment

The percent germination and the condition of the seedlings shall be determined. This shall be compared with the controls.

The condition of the new plants shall be noted for any abnormalities.

### IV. METABOLISM

Biochemical studies shall be made on plants that have been exposed to the lunar sample.

#### A. Protein metabolism

##### 1. Methods\*

- a. Specimens for these studies shall be obtained from the plants previously exposed in the experiments dealing with growth and development of the intact plant.

---

\* The methods previously described for Escherichia coli (or Chlorella) shall be followed.

- b. Protein synthesis shall be studied.
- c. Leucine-C<sup>14</sup> shall be used to determine the rate of incorporation of amino acids into proteins.
- d. More detailed studies can be made on a cell-free system for protein synthesis.

2. Assessment

- a. The effect of the lunar sample on total protein synthesis shall be determined.
- b. The scintillation spectrometer shall be used to determine the radioactivity of the isolated protein fraction.

3. Reference

Holley. Protein Metabolism in Plant Biochemistry by Bonner and Varner. Academic Press, N.Y.

B. Nucleic acid metabolism

1. Methods\*

Plants previously exposed to the lunar sample by the root drenching method shall be used.

Labeled adenine (C<sup>14</sup>) shall be used to study nucleic acid synthesis.

2. Assessment

The effect of the lunar sample on nucleic acid metabolism shall be determined.

3. Reference

Chargaff and Davidson. The Nucleic Acids. Academic Press.

C. Lipid metabolism

1. Methods\*

a. Labeled acetate shall be applied to bean plants previously exposed

---

\* The methods previously described for E. coli (or Chlorella) shall be followed.

to the lunar sample.

- b. Lipids shall be extracted from the plants by organic solvents.
- c. The lipid fractions shall be assayed by thin-layer chromatography and gas chromatography.
- d. The radioactivity shall be determined by the following methods:
  - (1) Radioautography
  - (2) Scintillation spectrometer with a flow cell.

## 2. Assessment

The effect of the lunar sample on lipid metabolism shall be determined.

## 3. Reference

Stumpf. Lipid Metabolism. Ann. Rev. Biochem. 29: 261.

## D. Carbohydrate metabolism

### 1. Methods\*

Plants exposed to the lunar sample shall be incubated with  $C^{14}$ -glucose.

### 2. Assessment

The effect of the lunar sample on the breakdown of carbohydrate shall be assessed.

- a. The amount of  $C^{14}O_2$  liberated shall be measured.
- b. Radioactivity shall be determined in a scintillation counter.

### 3. Reference

Calvin, M. and J. Bassham, 1962. The photosynthesis of carbon compounds. W.A. Benjamin, Inc., New York.

---

\* The methods previously described for E. coli (or Chlorella) shall be followed.

## E. Translocation: Water and food materials

### 1. Methods

- a. 15-30 days old bean seedlings shall be used in the translocation studies.
- b. The lunar sample shall be incorporated into the translocation solution.
- c. The solution shall contain  $C^{14}$  sucrose and a few drops of dye.
- d. Both intact plants and plants which have been cut under water shall be placed in the translocation solution for 6 and 12 hours.
- e. After 24 hours, the upper part of the plant shall be severed from the root section.
- f. The plant shall be pressed between two filter papers for 1-2 days at warm temperatures.
- g. The pressed plant shall be placed on Kodak X-ray film in a dark room and left for 1, 2, and 3 weeks.

### 2. Assessment

- a. Intact plants placed in the translocation solution shall be observed for wilting.
- b. The X-ray film of the pressed plant shall be developed at intervals to observe if radioactivity appears on the apical region of the plant.
- c. Radioautograms shall be compared with controls to determine the effect of the lunar sample on translocation.

## F. Respiration

### 1. Methods

- a. Exposed seedlings from the germination experiment shall be used.
- b. Bean seedlings that have been exposed by the root feeding method shall be used.

c. Leaf discs shall be cut from the leaves of the seedlings.

## 2. Assessment

The effect of the lunar sample on the respiration rate of the leaf discs shall be determined.

a. The oxygen electrode or the Warburg respirometer shall be used in the leaf disc studies to measure respiration.

b.  $C^{14}O_2$  incorporation shall be measured (see section on Chlorella for procedures).

## G. Cuttings

The leaf and stem techniques are short term experiments. Cuttings shall be used to determine any possible toxic effect of the lunar sample on plant tissue.

The lunar sample may enter the plant through the vascular system.

### 1. Methods

#### a. Leaves or leaf discs

(1) Single leaves or discs cut from leaves shall be floated on an aqueous solution of the lunar sample.

(2) A filtrate shall be made by adding the lunar sample to a water-alcohol mixture. The alcohol shall be evaporated off, and the solution filtered.

(3) The leaves or discs shall be exposed to this filtrate for one-half hour to 2 hours maximum.

#### b. Stem cuttings

Stem cuttings shall be made to assure the penetration of the lunar sample into the vascular system.

(1) The plants shall be cut at the stem (near ground level)



under water.

- (2) The cut plant shall be placed in a test tube containing an aqueous solution of the lunar sample.
- (3) The solution shall be made with a water-alcohol mixture of the lunar sample.
- (4) The cutting shall remain in the solution for 2-12 hours.
- (5) These plant cuttings shall be placed in the normal growth chamber.

## 2. Assessment

- a. Gross observations shall be made of any necrotic and chlorotic changes.
- b.  $C^{14}O_2$  incorporation shall be measured (see the section on Chlorella for procedures).
- c. The oxygen electrode or Warburg respirometer shall be used in the leaf disc studies to measure respiration.
- d. Enzyme assays shall be performed using gel electrophoresis. Assay methods are described in the Appendix.
  - (1) Peroxidase
  - (2) Acid phosphatase
  - (3) Malic dehydrogenase

CLASS ANGIOSPERMAE

SUBCLASS DICOTYLEDONAE

ORDER ROSALES

FAMILY LEGUMINACEAE

Vicia faba (broad bean)

I. GROWTH PROCESSES

A. Cell division

1. Methods

- a. Broad bean seeds shall be germinated at 23-25°C on cellulose paper pads or polyethylene beads.
- b. A 12-hour light cycle shall be maintained.
- c. The germination time shall be 4-14 days.
- d. Water or a nutrient solution shall be used. Any of the liquid tissue culture media that does not contain sugar may be used.
- e. Lateral roots will appear 5-6 days after germination.
- f. Actively growing roots and lateral roots shall be immersed in a beaker containing the lunar sample and incubated for 12-24 hours.
- g. The root tips shall be removed at intervals of 2, 4, 8, 12, and 24 hours. Standard squash techniques and staining shall be employed. Once the root tips are readily growing, the squash procedure (after incubating in test solutions) does not take more than 10 minutes.
- h. The root apices or shoot apices shall be fixed in acetic alcohol (95% ethyl alcohol 3 parts : glacial acetic acid 1 part) for 1-2-24 hours.
- i. Washed root tips shall be hydrolyzed in a vial containing 1 N HCl in a 60°C oven. The HCl shall be poured off.

- j. The roots shall be washed and stained with acetic orcein or Feulgen for 10-15 minutes.
- k. Slides shall be made permanent by the normal dry-ice technique.

## 2. Assessment

- a. The effect of the lunar sample on the sites of continuous meristematic activity in plants shall be determined by comparison of the experimentals and controls.
- b. Squashed cell preparations shall be examined microscopically for stages of nuclear division.
- c. Mitotic rate shall be analyzed, and the rate of mitosis determined.

## B. Genetic change: chromosomal aberrations

The cells of the broad bean have low chromosome numbers and morphologically distinct, visible and big chromosomes.

The diploid chromosome complement of Vicia faba consists of 5 pairs of acrocentric (S) chromosomes and one pair of metacentric (M) chromosomes.

The ratio of the total metaphase lengths of these chromosomes is M:S - 1:2.16.

### 1. Methods

- a. Procedures shall be followed as outlined in the section on cell division.
- b. A higher concentration of lunar sample shall be added to the liquid medium in which the root tips will be exposed.
- c. Slides shall be made of squash preparations using aceto-carmin or Feulgen stains.

### 2. Assessment

Various types of chromosomal aberrations will be discernible if the

lunar material has a mutagenic effect on the broad bean.

The slides shall be examined microscopically for the following:

- a. Loss of segment of a chromosome (deletion).
- b. Addition of chromosomal segment (duplication).
- c. Interchromosomal rearrangement by exchange of segments (translocation).
- d. Interchromosomal rearrangement by rotation of a segment 180 degrees, reversing the gene order (inversion).
- e. Variation in chromosome number leading to haploidy, polyploidy, aneuploidy (monosomic, polysomic, or nullisomic).
- f. Endopolyploidy or polyteny.
- g. Nature of mitotic spindle and, if abnormal, how affected.
- h. Effect on centriole
- i. Nature of spindle movement to the poles.
- j. These shall be compared with C-mitosis produced by colchicine.

### 3. References

Jensen, W.A., 1962. Botanical Histochemistry. W.H. Freeman & Co  
pp. 95-98.

De Robertis, E.D.P., W.W. Nowinski, and F.A. Saez, 1965. Cell  
Biology. W.B. Saunders & Co., pp. 253-271.

### 4. Source

United States Department of Agriculture.

## CLASS ANGIOSPERMAE

## SUBCLASS DICOTYLEDONAE

## ORDER ROSALES

## FAMILY LEGUMINACEAE

Pisum sativum (Alaska pea)

## I. GERMINATION

A. Seeds1. Methods

- a. Pisum sativum seeds shall be germinated at 20°C on cellulose paper pads or polyethylene beads in petri dishes containing sterile water and lunar sample.
- b. A 12-hour light cycle shall be maintained.
- c. The germination time shall be 4-6 days.

2. Assessment

- a. The percent germination shall be determined and compared with the controls.
- b. The condition of the seedling shall also be observed.

## II. METABOLISM

A. Nitrogen fixation1. Methods

- a. Surface sterilized seeds shall be soaked in a solution of the lunar sample for 2, 12, and 24 hours. The seeds shall be germinated in the following media:
  - (1) Sterile vermiculite
  - (2) Sterilized vermiculite that has been inoculated with Rhizobium.

b. 5-10 day old germinated seedlings shall be exposed to the lunar sample by the root drenching method for 2-4 hours. Exposed seedlings shall be planted in the following media:

(1) Sterile vermiculite

(2) Sterilized vermiculite that has been inoculated with Rhizobium.

2. Assessment

- a. The growth of the plant shall be determined after 10 days.
- b. Roots shall be examined for nodulation in the root system.
- c. Sections of the nodules shall be studied microscopically for the structure and nature of nodulation.

3. Reference

Stewart, W.D.P., 1966. Nitrogen fixation in plants. The Athlone Press, University of London.

4. Source

U. S. Department of Agriculture Seed Laboratories.

ATCC for Rhizobium leguminosarum.

## CLASS ANGIOSPERMAE

## SUBCLASS DICOTYLEDONAE

## ORDER UMBELLALES

## FAMILY UMBELLIFERAE

Daucus carota (carrot)

## I. GROWTH PROCESSES

A. Differentiation

Tissue level (formation of carrot tissue culture cells).

1. Methods

- a. The experiment shall be performed under sterile conditions.
- b. The outside of the carrots shall be swabbed with alcohol.
- c. Incisions shall be made with a sterile knife and a cylindrical piece of the carrot shall be obtained.
- d. A 0.05 cm diameter segment shall be cut using a sterile cork borer.
- e. This long piece shall be placed in a petri plate and cut into one cm segments.
- f. The carrot segments shall be transferred to White's nutrient media containing the lunar sample.
- f. Proliferation shall be detected within 2-3 weeks.

2. Assessment

- a. The exposed proliferated tissue shall be analyzed for growth and compared with the controls.
- b. The following data shall be obtained:
  - (1) The wet weight of the tissue.
  - (2) The dry weight of the tissue. The tissue shall be dried in an oven at 60°C.

- c. Population of cells/unit volume or /unit weight shall be determined.
- d. The mitotic index shall be obtained.
- e. The amount of DNA synthesis shall be assessed.

## B. Cell culture

### 1. Methods

- a. Tissue cultures which have been established and are actively growing shall be transferred to a liquid medium and placed on mechanical shakers.
- b. The cells and cell aggregates shall be dispersed and a cell suspension obtained.
- c. The cells shall be separated from the liquid by appropriate filtration procedures and used for differentiation studies.
- d. The cell suspension shall be plated on agar plates. This normally results in clone formation.

### 2. Assessment

- a. The wet weight and the dry weight of the proliferated tissue shall be determined.
- b. Population of cells/unit volume or /unit weight shall be determined.
- c. The effect of the lunar sample on specific organ differentiation shall be analyzed.
- d. The ability of exposed cell suspensions to undergo clone formation shall be determined.

### 3. Reference

Steward, F.C., 1963. The control of growth in plant cells. Scientific American, 209: 104-113.



4. Source

United States Department of Agriculture.

Tissue culture lines:

Philip White  
The Roscoe B. Jackson Memorial Laboratory  
Bar Harbor, Maine 04609

CLASS ANGIOSPERMAE

SUBCLASS DICOTYLEDONAE

ORDER TUBIFLORALES

FAMILY SOLANACEAE

Lycopersicon esculentum (tomato)

I. GERMINATION

A. Seeds

1. Methods

- a. Surface sterilized seeds shall be dusted or soaked in an aqueous solution of the lunar material.
- b. The seeds shall then be germinated and grown on filter paper or in petri dishes containing polyethylene beads in distilled water.
- c. The temperature shall be between 23-25°C.
- d. A 12-hour light cycle shall be used.

2. Assessment

- a. The percent germination shall be determined and compared to the controls.
- b. The condition of the germinated seedlings shall also be determined.

II. GROWTH PROCESSES

A. Organ level (root culture)

1. Methods

- a. Commercially available seeds shall be surface sterilized in commercial Clorox (15%) and washed in distilled water.
- b. Alternatively, seeds can be obtained from a full ripe tomato.
  - (1) The outside shall be swabbed with alcohol.

- (2) A sterile knife shall be used to remove the outer skin and make incisions exposing the seeds.
  - (3) The seeds, which are sterile under these circumstances, shall be removed and placed in petri plates.
  - (4) The jelly-like covering of the seeds shall be removed since this inhibits germination.
- c. The seeds shall be placed on filter paper soaked in sterile water.
  - d. In 3-4 days, the seeds will germinate giving rise to radicle elongation.
  - e. One cm segments of the apical portion of the root-tip shall be isolated.
  - f. The lunar sample shall be added to White's nutrient medium (liquid).
  - g. The 1 cm segments shall be transferred to containers of this solution. by means of a bacteriological loop.

## 2. Assessment

- a. The following data shall be obtained:
  - (1) After one week, the length of each root shall be measured and the number of lateral roots counted. These determinations shall be continued for 3-4 weeks.
  - (2) The wet weight of the root cultures shall be obtained.
  - (3) The dry weight of the root cultures shall be obtained by drying the roots in an oven at 60°C.
- b. A comparison of the experimental and control data shall be made to determine the effect of the lunar sample on cell proliferation and differentiation.

## 3. Reference

White, P.R., 1963. The Cultivation of Animal and Plant Cells. The Ronald Press Co., New York.

4. Source

Locally available.

United States Department of Agriculture.

CLASS ANGIOSPERMAE

SUBCLASS DICOTYLEDONAE

ORDER TUBIFLOSALES

FAMILY SOLANACEAE

Nicotiana tabacum (tobacco)

I. GROWTH PROCESSES

A. Differentiation: tobacco pith tissue culture

1. Methods

- a. Pith tissue shall be isolated from internode regions of mature tobacco plants growing in growth chambers.
- b. Experiments shall be performed as outlined for carrot tissue.
- c. Effect of plant auxins

Organ differentiation in plants can be manipulated by adjusting minute concentrations of specific substances incorporated into the culture medium.

Increased phosphate concentration or addition of kinetin (6-furfurylamino purine) and indole acetic acid (IAA) particularly influences organ differentiation.

- (1) Isolated pith tissue shall be inoculated into flasks as follows:

Concentration of Plant Auxins (mg/l)

Substance	Flask 1	Flask 2	Flask 3	Flask 4	Flask 5
IAA	0	3	3	0.03	none
Kinetin	0	0.2	0.02	1	0.2
Results	slight enlargement	Callus	Roots	Shoots	no growth

- (2) The lunar sample shall be added to flasks prepared in a similar manner.

## 2. Assessment

The effect of the lunar sample on organ differentiation shall be assessed by comparing cultures exposed to lunar sample with the controls.

## B. Cloning: tobacco pith tissue

### 1. Methods

- a. Tissue cultures which have been established and are growing actively shall be transferred to a liquid medium and placed on mechanical shakers.
- b. The cells and cell aggregates shall be dispersed and a cell suspension obtained.
- c. Cells shall be separated from the liquid by appropriate filtration procedures and used for differentiation studies.
- d. The cell suspension shall be plated on agar plates. This normally results in clone formation.

### 2. Assessment

- a. The proliferated tissue shall be analyzed for growth.
  - (1) The wet weight shall be determined.
  - (2) The dry weight shall also be determined.
  - (3) The population of cell/unit volume or /unit weight shall be obtained.
- b. The effect of the lunar sample on specific organ differentiation shall be analyzed.
- c. The ability of exposed cell suspensions to undergo clone formation shall be determined.
- d. Single cells shall be isolated and protoplasmic movements observed microscopically.

### 3. Reference

Skoog, F. and C. O. Miller, 1957. Biological action of growth substances. Symposium, Society of Experimental Biology, 11: 118.

### C. Dynamics of movement: protoplasmic streaming

#### 1. Methods

- a. Tissue culture cells and tobacco hair cells shall be aseptically prepared by the previously described methods.
- b. The materials shall be placed on a microslide with a circular vaseline chamber.
- c. The lunar sample shall be incorporated into the liquid medium which is added to the cells in the chamber on the slide.
- d. The chamber shall be sealed with a cover slip.

#### 2. Assessment

- a. The effect on the different aspects of protoplasmic movements shall be analyzed. The failure to maintain normal cellular activities may be indicative of toxicity of the sample.
- b. Cells shall be observed using phase-contrast microscopy and recording by cinemicrographic methods.
- c. Micrometric measurements shall be prepared from frame enlargements of known dimensions.
- d. The following movements shall be assessed:
  - (1) Streaming
  - (2) Mass flow
  - (3) Formation of vacuoles
  - (4) Localization of metabolic products by cytochemical tests (vital stains)

### 3. Reference

Mahlberg, P.G. and S. Venketeswaran, 1963. Phase cinemicrographic observations on cultured cells of Euphorbia marginata. Amer. J. Bot. 50: 507-513.

### 4. Source

Plants shall be grown from seeds obtained from the U.S. Department of Agriculture.

#### Tissue culture lines:

Dr. Albert C. Hildebrandt  
Department of Plant Pathology  
University of Wisconsin  
Madison, Wisconsin 53706

Dr. S. Venketeswaran  
Department of Biology  
University of Houston  
Houston, Texas 77004



## CLASS ANGIOSPERMAE

## SUBCLASS DICOTYLEDONAE

## ORDER SCROPHULARIALES

## FAMILY SCROPHULARIACEAE

Antirrhinum majus (snapdragon)

## I. REPRODUCTIVE STAGE

A. Sexual: pollen1. Methods

- a. Flowers shall be obtained before the anthers have dehisced.
- b. The pollen shall be stored in a dry state in petri dishes or in a refrigerator.
- c. Pollen shall be exposed to an aqueous solution or powder of the lunar sample. The pollen shall then be placed on the surface of an agar medium in petri plates.
- d. Alternatively, the pollen shall be allowed to germinate in petri plates in a culture medium containing the lunar sample. See appendix for composition of medium.

2. Assessment

- a. The pollen shall be observed microscopically.
- b. The following events shall be studied using phase contrast microscopy.
  - (1) Formation of pollen tube, streaming, and rate of growth.
  - (2) Nuclear division.

3. Reference

Eigsti, O.J., 1966. Pollen tube cultures for teaching and research. *Turttox News*, 44: 162-166.

4. Source

Cut flowers are locally available.

## CLASS ANGIOSPERMAE

## SUBCLASS DICOTYLEDONAE

## ORDER ASTERALES

## FAMILY COMPOSITAE

Lactuca sativa, var. Grand Rapids (lettuce)

## I. GERMINATION

A. Seeds1. Methods

- a. 50 surface-sterilized seeds of Lactuca sativa shall be placed in water for 16 hours.
- b. The lunar material shall then be dusted on the surface-sterilized seeds.
- c. Alternately, the soaked surface-sterilized seeds shall be placed in a solution of the lunar sample for 2, 4 and 12 hours.
- d. After exposure, the seeds shall be placed in petri plates containing filter papers soaked in culture media or distilled water.
- e. The seeds shall be allowed to germinate under the following conditions in special growth chambers.\*

- (1) Dark
- (2) White light
- (3) Red light (R)
- (4) Far-red light (FR)
- (5) FR → R

2. Assessment

- a. The percent germination shall be calculated and compared with the control seeds.

---

\* Growth chamber: A light tight box can be made from plywood, sealed with plastic wood and painted black on the inside.

- b. The effect of the lunar sample on the red and far-red response in seed germination shall be determined.

3. Reference

Borthwick, H.A., S.R. Hendricks, E.H. Toole and V.K. Toole, 1954.  
Action of light on lettuce seed germination. Bot. Gaz. 115: 205-225.

4. Source

U.S. Department of Agriculture Seed Laboratories.

Ferry Morse Seed Co., Mountain View, California.

Light sources:

Red filter: This is made by binding two thicknesses of DuPont 300 MSC red cellophane between two pieces of glass. The red filter is placed about 1 meter from the fluorescent bulb.

Blue filter: This is made by using DuPont 300 MSC dark blue cellophane as described above.

Far red: This is obtained by using both the red and blue filter and an incandescent bulb. This is also placed about 1 meter from the incandescent bulb.

## CLASS ANGIOSPERMAE

## SUBCLASS DICOTYLEDONAE

## ORDER ASTERALES

## FAMILY COMPOSITAE

Xanthium pennsylvanicum (cocklebur)

## I. GROWTH PROCESSES

A. Flowering1. Methods

- a. Xanthium plants shall be maintained in a gnotobiotic environment under short-day (SD) conditions (16 hours dark-8 hours light) at 23°C.
- b. The plants shall be exposed to the lunar sample by immersing the root systems in a solution of the sample for 2-12 hours.
- c. After treatment the plants shall be exposed to long-day (LD) conditions.

2. Assessment

- a. Flowering should appear within 2 weeks.
- b. The growing points and apices shall be examined at intervals under a dissecting microscope.
- c. The effect of the lunar sample on the flowering process shall be determined.

3. Reference

Hillman, W.S., 1963. The Physiology of Flowering. Holt, Rinehart & Winston, Inc., New York.

Salisbury, F.C., 1963. The Flowering Process. Macmillan Press, New York.

4. Source

U.S. Department of Agriculture.

REFERENCES - RECOMMENDED BOOKS AND LABORATORY MANUALS

- Alexopoulos, C.J., 1962. Introductory mycology, p. 428, John Wiley and Sons, Inc. N.Y.
- Altman, P.L. and D.S. Dittmer (Editors), 1962. Growth including reproduction and morphological development. Fed. of Amer. Soc. for Exp. Biol., Washington. D.C.
- Anderson, H.W., 1956. Diseases of fruit crops, p. 501. McGraw-Hill Book Co. Inc. N.Y.
- Bahrt, G.M. et al., 1941. Hunger signs in crops. A symposium (Gove Hambide ed.) American Society of Agronomy and National Fertilizer Association, Washington, D.C.
- Barnett, H.L., 1955. Illustrated genera of imperfect fungi, p. 218. Burgess Publ. Co., Minneapolis 15, Minn.
- Bawden, F.C., 1964. Plant viruses and virus diseases, 4th Ed., p. 361. Ronald Press Co., N.Y.
- Bonner & Varner, 1965. Plant biochemistry, Academic Press, New York.
- Campbell, P.A. (Ed.), 1961. Medical and biological aspects of the energies of space. Columbia University Press, New York
- Chupp, C. and A.F. Sherf, 1960. Vegetable diseases and their control, p. 693. Ronald Press Co., N.Y.
- Cochrane, V.W., 1958. Physiology of the fungi, p. 524, John Wiley and Sons, N.Y.
- Corbett, M.K. and H.D. Sisler, 1964. Plant virology, p. 527. University of Florida Press, Gainesville, Fla.
- DeRobertis, Nowinski, Saex, 1965. Cell biology. W. B. Saunders Co., Philadelphia, Pa.
- Dickson. J.G., 1956. Diseases of field crops, 2nd ed., p. 517. McGraw-Hill Book Co., Inc., N.Y.
- Forsberg, J.L., 1963. Diseases of ornamental plants, p. 208. Univ. of Illinois, College of Agriculture, Special Publication No. 3
- Gautheret, R.J., La culture de tissus vegetaux. Masson et Cie., Paris, 1959.
- Gregory, P.H., 1961. The microbiology of the atmosphere, p. 251. Interscience Publ., N. Y.

- Johansen, D.A., 1940. Plant microtechnique, McGraw-Hill Book Co., New York.
- Johnson, L.E., E.A. Curl, J.H. Bond, and H.A. Fribourg, 1959. Methods for studying soil microflora-plant disease relationships, p. 178. Burgess Publ. Co., Minnesota.
- Leopold, A.C., 1964. Plant growth and development. McGraw-Hill Book Co., N.Y.
- Machlis & J.G. Torrey, 1956. A lab manual of plant physiology. W.H. Freeman & Co., San Francisco.
- Maheshwari & Ranga Swamy (Ed.), 1963. Plant tissue and organ culture--a symposium, Catholic Press, Ranchi, India.
- Meyer & Anderson, 1960. Introduction to plant physiology. Van Nostrand Co., Inc., New York.
- Stapp, C., 1961. Bacterial plant pathogens, p. 292. Transl. by A. Schoenfeld, Oxford University Press.
- Thorne, G., 1961. Principles of nematology, p. 553. McGraw-Hill Book Co., Inc. N.Y.
- Wallace, H.R., 1964. The biology of plant parasitic nematodes, p. 280. St. Martin's Press, Inc., N.Y.
- White, P.R., 1963. The cultivation of animal and plant cells. The Roland Press Co., New York.
- Wolff, S. (Ed.), 1963. Radiation-induced chromosome aberrations, Columbia University Press, New York.
- Index of plant diseases in the United States. 1960. U.S.D.A. Agricultural Handbook p. 165, 531. U.S. Government Printing Office, Washington 25, D.C.
- Plant growth regulation, Intl. Conf. on Plant Growth Regulation, Iowa State University Press, Ames, Iowa, 1961.
- Effects of ionizing radiations on seeds, 1961. Symp. of International Atomic Energy Agency held in Vienna.
- Photosynthetic mechanisms of green plants, 1963. Symp on Photobiology, Natnl. Acad. of Sci., Washington, D.C.

## CHALLENGE OF BACTERIAL, ANIMAL, AND PLANT VIRUSES

The effect of the lunar sample on viral development and proliferation shall be observed. Prime sterile sample is not required for these tests unless the presence of enhancing agents or helper viruses is being investigated. Of these three viral systems, the bacterial viruses are the easiest to work with, require the least space and results are obtainable in the shortest period of time. More detail is therefore presented in this area.

## I. TYPES OF VIRUSES

A. Bacterial viruses

## 1. DNA bacteriophages

- a. T<sub>4</sub> (virulent) (Escherichia coli K 12 and B)
- b. Lambda (temperate) (E. coli K 12)
- c. P 22 (temperate) (Salmonella typhimurium LT 2 or LT 7)
- d.  $\phi$ X 174 (single-stranded DNA) (E. coli C)

## 2. RNA bacteriophages

- a. MS-2 (E. coli K 12 male)

B. Animal viruses

1. Polio (RNA)
2. Polyoma (DNA)
3. Adeno (DNA)

C. Plant viruses

1. Tobacco mosaic virus (RNA)
2. Turnip yellow virus (RNA)

3. Tomato bushy stunt virus (RNA)
4. Alfalfa mosaic virus (RNA)

## 11. METHODS

### A. Growth and Maintenance

#### 1. Bacterial viruses

- a. T<sub>4</sub> bacteriophage shall be grown in E. coli K 12 or B.
- b. Lambda shall be maintained in E. coli K 12. This phage shall be induced by brief exposure to U.V.
- c. P 22 shall be maintained in Salmonella typhimurium LT 2 and LT 7. It shall be induced by exposure to U.V.
- d. ØX 174 shall be grown in E. coli C.
- e. MS-2 shall be grown in a male E. coli K 12.

The procedures for growing, harvesting, and maintaining bacteriophage are found in the references at the end of this section.

#### 2. Animal viruses

Animal viruses shall be grown in appropriate tissue cultures.

They shall be harvested and stored according to the procedures listed in the viral protocols and appendix.

#### 3. Plant viruses

Plant viruses shall be grown in the appropriate plants or plant tissue cultures, harvested and stored according to the procedures listed in the plant protocols and appendix.

### B. Challenge

Sterilized lunar sample, suspensions or supernatants shall be



used in these studies.\*

1. Bacterial viruses

- a. Bacteriophages shall be incubated in suspensions of the lunar sample, washed and added to the appropriate bacterial cultures.
- b. The lunar sample shall be added to the bacterial cultures before inoculation with phage.
- c. The lunar sample shall be added to bacterial cultures within 5 minutes after infection.

2. Animal viruses

- a. Viruses shall be incubated in suspensions of the lunar sample, washed and inoculated into animals or tissue cultures.
- b. The lunar sample shall be added to tissue cultures before inoculation with viruses.
- c. The lunar sample shall be added to previously infected tissue cultures or animals.

3. Plant viruses

- a. Viruses shall be incubated in suspensions of the lunar sample, washed, and inoculated into appropriate plants or plant tissue cultures.

---

\* Previous control testing shall indicate the advisability of adding dry material directly to tissue cultures, etc. Suspensions or supernatants suitably "neutralized" may be indicated.

Testing for the presence of helper viruses or enhancing agents shall require non-sterile samples.

- b. The lunar sample shall be added to plants or plant tissue cultures before inoculation with viruses.
- c. The lunar sample shall be added to plants or plant tissue cultures previously infected with viruses.

### III. ASSESSMENT

#### A. Bacterial viruses \*

The effect of the lunar sample shall be observed on:

##### 1. T<sub>4</sub> bacteriophage

T<sub>4</sub> bacteriophage shall be used to determine the effect of the lunar sample on mutation rate of bacterial viruses.

Wild type T<sub>4</sub> phage and rII mutants which are transition mutants from  $\frac{G}{C} \rightarrow \frac{A}{T}$  and  $\frac{A}{T} \rightarrow \frac{G}{C}$  shall be examined for the forward mutation or reverse mutation to wild type as described by Drake (1966). Transversion mutants  $\frac{A}{T} \leftrightarrow \frac{T}{A}$  and  $\frac{A}{T} \rightarrow \frac{C}{G}$  and sign mutants induced by acridine dye shall also be examined for reversion to wild type. The effect on survival of infectious particles shall also be determined.

##### 2. Lambda bacteriophage

Lambda bacteriophage is a temperate phage which lysogenizes E. coli K-12. The prophage can be induced to enter into the vegetative phase of replication by ultraviolet radiation of the lysogenic bacteria. Other treatments such as exposure to nitrogen mustard or mitomycin C will also cause induction. The effect

---

\* References to procedures used in growing phage and bacteria, as well as performing the various experiments are given at the end of this section.

of the lunar sample on the frequency of induction of lambda phage development shall be determined.

3. P22 bacteriophage

P22 temperate phage is a generalized transducing phage for Salmonella typhimurium LT2 and LT7. The effect of the lunar sample shall be determined on:

1. The survival of plaque-forming units
2. Host bacteria
3. Mutation from temperate to virulent phage
4. Efficiency of transduction
5. Relative frequency of lysogenic or lytic response to phage infection when treating either the virus or the host cell
6. Total progeny

4.  $\phi$ X 174 and MS-2 bacteriophages

The effect of the lunar sample on the survival of plaque-forming units of the single-stranded DNA phage  $\phi$ X 174 and the male-specific RNA phage MS-2 shall be similarly determined.

B. Animal viruses

The effect of the lunar sample shall be observed on:

1. Viral proliferation
2. Morphogenesis
3. Virulence
4. Mutagenesis
5. Tumor induction (polyoma)

C. Plant viruses

The effect of the lunar sample shall be observed on:

1. Viral proliferation
2. Morphogenesis
3. Mutagenesis
4. Virulence

IV. REFERENCES

A. Bacterial viruses

General Reference for preparing phage lysates and determining the plaque-forming units of phage.

Adams, M.H. 1959. Bacteriophages. Interscience Publishers Inc. New York.

T4 Phage

Benzer, S. 1955. Fine structure of a genetic region in bacteriophage. Proc. Natl. Acad. Sci., 41, 344.

Benzer, S. 1961. On the topography of the genetic fine structure. Proc. Natl. Acad. Sci., 47, 403.

Freese, E. 1963. Induced and spontaneous mutations in bacteriophage in Methodology in Basic Genetics Ed. by Burdette, W.J. Holden-Day Inc. San Francisco. p.3.

Drake, J.W. 1966. Spontaneous mutations accumulating in bacteriophage T4 in the complete absence of DNA replication. Proc. Natl. Acad. Sci., 55, 738.

Lambda Phage

Lwoff, A. 1953. Lysogeny Bacterial Rev., 17, 270.

Kaiser, A.D. 1957. Mutations in a temperate phage affecting its ability to lysogenize E. coli *Virology*, 3, 42.

Heinemann, B. and Howard, A.J. 1964. Induction of lambda-bacteriophage in Escherichia coli as a screening test for potential antitumor agents. *Applied Microbiol.*, 12, 234.

#### P22 Phage

##### a. Transduction

Demerec, M., Hartman, Z., Hartman, P.E., Yura, T., Gots, J.S., Ozeki, H., Glover, S.W. 1956. Genetic studies with bacteria. Carnegie Institution of Washington Publication 612, Washington, D.C.

Hartman, P.E. 1963. methodology in transduction in *Methodology of Basic Genetics* Ed. Burdette, W.J. Holden-Day, San Francisco, 103.

##### b. Lysogeny by P22 and Mutations Affecting it

Levine, M. 1957. Mutations in the temperate phage P22 and lysogeny in *Salmonella*. *Virology* 3, 22, 1957.

#### ØX 174 Phage

Sinsheimer, R.L. 1959. Purification and properties of bacteriophage ØX 174 *J. Mol. Biol.* 1, 37. 1959.

Sinsheimer, R.L. 1959. A single-stranded DNA from bacteriophage ØX 174 *J. Mol. Biol.* 1, 43.

Denhardt, D.T. and Sinsheimer, R.L. 1965. The process of infection with bacteriophage  $\phi$ X 174 III Phage maturation and lysis after synchronized infection. J. Mol. Biol., 12, 641.

MS-2 Phage

Loeb, T. and Zinder, N.D. 1961. A bacteriophage containing RNA. Proc. Natl. Acad. Sci., 47, 282.

Davis, J.E. and Sinsheimer, R.L. 1963. The replication of bacteriophage MS-2. 1. Transfer of parental nucleic acid to progeny phage. J. Mol. Biol., 6, 203.

B. Animal and plant viruses

See protocol for references on other viruses.

APPENDIX

LUNAR RECEIVING LABORATORY

by

James C. McLane, Jr., Elbert A. King, Jr., Donald A. Flory,  
Keith A. Richardson, James P. Dawson, Walter W. Kemmerer,  
Bennie C. Wooley

Science, 3 February 1967, Volume 155,  
Number 3762.



### LUNAR RECEIVING LABORATORY

Unique requirements for handling lunar samples and quarantining for back-contamination are provided

The arrival on Earth of samples of lunar rock carefully collected by Project Apollo will present an unparalleled opportunity to examine extraterrestrial materials under controlled conditions. Unless such samples are collected and handled with great care, a considerable amount of unique scientific information will be lost (1). The scientific importance of these samples has prompted the National Aeronautics and Space Administration (NASA) to obtain the expert opinions and guidance of many scientists in establishing the requirements for the Lunar Receiving Laboratory now under construction at the Manned Spacecraft Center in Houston, Texas (Figs. 1 and 2). Contributions have come from many NASA-sponsored advisory groups and, in particular, on a continuing basis, from a group established for that purpose by the NASA Office of Space Sciences and Applications (2).

It was soon established that the receiving laboratory should have four major functions: (i) distribution of lunar samples to the scientific community for detailed investigations after a period of biologic quarantine; (ii) performance of scientific investigations of samples that are time-critical and must be accomplished within the quarantine period; (iii) permanent storage under vacuum of a portion of each sample; and (iv) quarantining and testing of the lunar samples, spacecraft, and astronauts for unlikely, but potentially harmful, back-contamination (contamination of extraterrestrial origin).

### SAMPLE-HANDLING PROCEDURES

The samples of rock will arrive on Earth aboard an Apollo spacecraft in two vacuum-sealed containers totaling about 56 liters in volume. The total allowance of weight for scientific material coming from Moon is 36.2 kilograms; this will include approximately 23 kilograms of packaged samples of lunar rock. It is planned that each of the general-purpose samples collected on Moon will be individually packaged in a vacuum-sealed bag and packed into the larger boxes; exceptions may be very small samples (of which several may be packaged together) and samples collected for special purposes. Special-purpose samples include two "lunar environment" rock samples, rock samples reserved for experiments in gas analysis, and samples aseptically collected for biologic examination. The "lunar-environment" samples will be packaged in containers designed to hold statically the best possible vacuum and transport the specimens under a pressure as close to that of the lunar atmosphere as is possible within weight and volume constraints. The gas-analysis and biologic samples will be collected and packaged on Moon by use of techniques, now under development, that will prevent contamination that might lead to incorrect conclusions from the investigations.

The main operational areas of the receiving laboratory for processing the returned samples are the Sample Laboratory and Vacuum Laboratory, which contain the cabinet barrier systems behind which the samples are handled (Fig. 2). Many of the operations in connection with the samples must be performed under vacuum in order to minimize terrestrial organic and inorganic contamination. The Vacuum Laboratory contains a unique vacuum system that

is ultra clean, provides a primary biologic barrier, and has manipulative capability for handling the samples. The primary function of the vacuum system is to serve as a receiving center for the samples and as a distribution point for other portions of the receiving laboratory and, later, for the scientific community; some of the vacuum systems are used for outgassing and sterilizing tools and containers for out-bound flights.

Dry heat is the primary means of sterilizing the vacuum systems and the equipment being prepared for flight. Cryogenically trapped pumps comprise the primary pumping systems. The use of elastomeric material is minimized; it is restricted to specific fluoro-carbons that can be easily discriminated as contaminants. Most of the sample operations in the chamber are conducted under a pressure of  $1 \times 10^{-6}$  torr or lower. The special lunar-environment rock samples are opened, divided, and repackaged for distribution under a pressure no higher than  $1 \times 10^{-11}$  torr.

The operations performed on incoming samples in the vacuum systems and cabinetry of the Vacuum Laboratory are: unwrapping and sterilizing the outside of the containers; opening and unpacking the containers under high vacuum; sampling of effluent gases; visual examination, photography, and division, and delivery of portions of the samples to other areas of the receiving laboratory for specific investigations. Chips removed from each sample in the high-vacuum system are repackaged in small vacuum containers and passed through transfer tubes to the Physical-Chemical Test Laboratory and the Biological Preparation Laboratory.

#### TESTS AND ANALYSES OF SAMPLES

The chips and aseptically collected biologic samples will be prepared, for quarantine testing, in the sterile environment of the Biological Prepara-

tion Laboratory cabinet system; preparation will consist of extracting biologic materials from each sample and preparing the extracts for specific quarantine examinations in other cabinet systems in the Sample Laboratory. These examinations will include aerobic and anaerobic culturing; inoculation of plants, eggs, tissue cultures, amphibia, invertebrates, and normal and germ-free animals; and biochemical analyses. A detailed, comprehensive test protocol is currently under development.

The chips and small samples passed to cabinets in the Physical-Chemical Test Laboratory will first be tested for reactions with atmospheric gases and water vapor. These tests are designed to determine whether lunar samples will suffer any degradation, or significant change in their mineralogic composition or physical properties, as a result of exposure to Earth's atmosphere, that will seriously affect subsequent handling and examination. Only small chips will be exposed in this manner while the main portion of each sample is maintained under vacuum. The chips will then pass into another cabinet containing dry, sterile nitrogen, where preliminary examination of the mineralogy, petrography, and chemistry of the samples will be performed. Such basic equipment as petrographic microscopes, chemical reagents, an optical spectrograph, and small hand tools for investigation of physical properties will provide information about each sample.

Detailed investigations of the mineralogic, petrologic, geochemical, and physical properties of the samples will be performed in many laboratories throughout the scientific community after the quarantine period; they will include comprehensive analyses of major and minor elements and of isotopes, mineral identification and description, analyses of any organic compounds, and determinations of physical properties. However, two experiments, effluent-

gas analysis and gamma-radiation counting, are time-critical or are linked to basic operations in the receiving laboratory; they will be performed there in a more sophisticated manner.

An early determination will be made, by visual inspection in the  $10^{-6}$ -torr chambers, of which individual large samples may be the most interesting for gamma-ray spectrometry. Samples collected on the surface of Moon, where they are not protected from cosmic rays and solar protons by a shielding atmosphere or a substantial magnetic field, will contain induced radioactive nuclides in addition to the radioisotopes found in terrestrial rocks. Analysis of the gamma radioactivity will yield information on the composition of the sample and on the history of the activating radiation; thence may come clues to the origin and history of the lunar material. Gamma-ray spectrometry will be performed in the receiving laboratory during the quarantine period, before many of the shorter-lived nuclides decay; later recounting of each sample will yield better information regarding the abundance of some isotopes after the shorter-lived nuclides have decayed.

Lunar samples may not be much more active than meteorites, and the weaker activities in meteorites cannot be adequately detected and measured with existing facilities. Thus one must analyze the lunar samples by use of the best possible counting equipment and shielding in an environment of steady, low-radiation background. The gamma-ray counting room (Fig. 4) will be located approximately 15 meters underground; the walls of the room will be lined with 91 centimeters of crushed dunite held in place by a steel liner. Selection of construction materials for low activity, and a radon-free atmosphere provided by a special ventilation system, will combine with the underground location to reduce the radioactive background to an expected 0.1 to 0.2 count per minute

per cubic centimeter of detector in the energy range 0.1 to 2.0 Mev. Anti-coincidence mantles enclosing the 23- by 13-centimeter sodium iodide detectors will further reduce the background by a factor of 10 to 100.

The radiation-counting data-acquisition system will be capable of handling data from two coincidence spectrometers. The system will consist of four analog-to-digital converters, each with a 4096-channel full-scale range and a fast memory capable of storing the equivalent of an array of 128 by 128 channels for each coincidence system.

The return of lunar samples in vacuum-tight containers will offer the first opportunity for comprehensive study of the gases in extraterrestrial materials without the usual problems of terrestrial contamination; similar investigations of meteorites have yielded a wealth of data. Facilities will be provided within the Gas Analysis Laboratory of the receiving laboratory for several individual but closely related experiments in analyses of gases:

- 1) Gas in the outer box containing the samples and in the inner sample bags will be analysed in the high-vacuum chamber as each individual container is first penetrated. This analysis will provide a sensitive test of the quality of the seal of each container, of the outgassing of the container itself, and of the composition and amount of gas that may have been released from the sample under ambient conditions.
- 2) Analysis of gas evolved during the splitting and preliminary examination of the lunar environment rock samples, which will be accomplished in the  $5 \times 10^{-11}$ -torr chamber; this analysis should provide the same types 1, except that some occluded.
- 3) Analysis of the gases evolved upon opening and heating of the special gas-analysis samples; this should provide a complete gas composition-temperature

profile for several lunar samples, which will include gas already in the container when it is opened, gas adsorbed on the surface of the sample, and interstitial and occluded gases.

- 4) Analysis of gas released or gaseous reaction products evolved during the atmospheric-reaction tests in the Physical-Chemical Test Laboratory.

#### BACK-CONTAMINATION

Much of the design of the receiving laboratory is based on the fact that lunar samples must be considered a potential source of back-contamination. Various responsible scientific bodies including the Space Science Board of the National Academy of Sciences, have expressed serious concern with the possibility of biologic back-contamination from extraterrestrial exploration (3). In the case of Moon, the low atmospheric pressure, large surface-temperature variation, probable absence of free water, severe surface-irradiation environment, and continual impingement of meteoroids on the surface make the existence of a near-surface lunar biosphere, containing terrestrially compatible forms of life, highly unlikely. The probability of finding such forms in the less stringent environment of the lunar subsurface may be somewhat higher. However, it is widely believed that lunar material must arrive more or less continually on Earth as meteorites; that these pieces have escaped from the lunar surface as secondary ejecta when a primary meteoroid impacted the lunar surface. Such lunar material could reach Earth without its entire microbial load being killed, yet no forms of life are known to have arrived on Earth in this manner. Nevertheless, the return of men and samples from the surface of a foreign celestial body entails some very small risk of back-contamination that could adversely affect the terrestrial biosphere.

For specific guidance in matters relating to back-contamination, NASA

is relying on the expert advice of the Interagency Committee on Back Contamination (4), which was established for this purpose at the request of NASA.

The biologic-containment systems used in the receiving laboratory must not only prevent the escape of material that could adversely affect the terrestrial biosphere; they must also prevent terrestrial organisms from contaminating the lunar samples. Biologic integrity of the samples must be maintained to prevent incorrect interpretations of biologic and organic analyses.

The astronauts, having been on the lunar surface, will be considered exposed to lunar material; thus they will be quarantined in the receiving laboratory. Recovery and transport of the astronauts to this laboratory will be accompanied by appropriate means of biologic isolation. During the biologically isolated recovery operation, the astronauts will remove the two rigid, vacuum-sealed containers of lunar samples from the spacecraft and take them into the mobile isolation unit: there the containers will be wrapped and sealed within biologic barriers, decontaminated, and passed for rapid jet transport to the receiving laboratory. The interior of the command module (the returning element of the spacecraft) may come in contact with a small amount of lunar material that has been tracked in by the astronauts; in any case it will contain the astronauts for more than 2 days after their lunar exposure. Thus it must be considered contaminated; after removal of the astronauts and sample containers, it will be sealed for the duration of the quarantine.

The exterior of the spacecraft will be considered biologically clean because the command module will not have contacted the lunar surface, and



because of the high temperatures experienced by the whole surface during reentry. The sealed spacecraft will be transported to the receiving laboratory for secure biologic isolation where it will be available for any essential post-flight examination. The samples will arrive first at the receiving laboratory where they will be introduced immediately into the biologic-barrier system. Photographic film and magnetic data tapes from the spacecraft will arrive with the samples, and will be sterilized, by ethylene oxide treatment, for retrieval of data outside the biologic barrier. Arriving some hours later in their mobile isolation unit, the astronauts will be transferred to the crew-reception area of the receiving laboratory.

The advisability of quarantining in a single facility all possibly hazardous material arriving from Moon has been pointed out by many consultants as necessary to increase positive control of biologic integrity. Container-opening operations and subsequent tests and examinations of samples will be conducted behind the two-way biologic-barrier system composed of gas-tight glove cabinets and vacuum chambers. This system is unique in that conventional containment systems are designed to prevent contamination in one direction only. The two-way system will protect laboratory scientists and technicians on the outside from contact with possible lunar biologic materials; at the same time it will protect the samples on the inside from terrestrial biocontamination. Second-line containment to guard the public health in the event of a break in this system is provided by features of building design and construction that establish a biologic barrier surrounding the entire area of sample operations. This barrier is characterized by such features as sealed walls, floors, and ceilings; control of leak-path direction by air-pressure differentials; single

passage air conditioning, with biologic filters on intake and exhaust; incineration of effluent air; and control and sterilization of liquid effluents.

The immediately adjacent Crew Reception Area, where the astronauts are isolated during quarantine, is similarly built. The area not only provides for the crew, postflight medical team, and support personnel during the quarantine period; it also has the contingency capability of housing all personnel that might be exposed to biologic hazards in the sample laboratory by failure in a barrier system. It is anticipated that the period of quarantine for samples will be about 30 days, which period the laboratory is capable of extending if a specific problem of back-contamination emerges.

#### CONCLUSION

The Lunar Receiving Laboratory will be the permanent depository of a portion of the collection of lunar samples; it will safeguard the collection, providing continuing security and ensuring scientific integrity. In carrying out the time-dependent experiments and continuing functions of the laboratory, NASA will rely on visiting expert scientists supplementing a relatively small resident staff; outside scientists will be relied upon for most investigations and detailed analyses of samples. It is believed that the designed procedures and facilities provided will ensure the maximum scientific return from the Apollo Program in the way of information from lunar samples.

#### REFERENCES AND NOTES

1. NASA, NASA 1965 Summer Conf. on Lunar Exploration and Science, NAS SP-88 (U.S. Government Printing Office, Washington, D.C., 1965), p. 421.
2. The following, as members of the OSSA ad hoc Committee or of the Lunar Receiving Laboratory Working Group of the Planetology Subcommittee, or of both, have been closely involved and especially helpful in defining

the scientific requirements and reviewing progress of the receiving laboratory: E.C.T. Chao (U.S. Geological Survey); Clark Goodman (Univ. of Houston); J.R. Arnold and A. Burlingame (Univ. of California); P.R. Bell (Oak Ridge National Laboratory); James Devoe (NBS); D.A. Flory, E.A. King, Jr., and J.C. McLane, Jr. (Manned Spacecraft Center); Clifford Frondel (Harvard Univ.); W.F. Hardgrove and Jacob Trombka (Goddard Space Flight Center); Jonathon Klein (Ames Research Center); Charles Phillips (U.S. Army Chemical Corps); G.B. Phillips (USPHS); Oliver Schaeffer (State Univ. of New York); and Peter Signer (Eidgenosische Technische Hochschule, Zurich).

3. Space Science Board, Nat. Acad. Sci., Conf. on Potential Hazards of Back Contamination from the Planets 29-30 July 1964, p. 15
4. Chairman: David Sencer (USPHS); Wolf Vishniac (NAS); Ernest Saulmon (USDA); John Buckley (USDI); and H.P. Klein, C.A. Berry, Aleck Bond, and Leonard Reiffel (NASA); executive secretary; J.E. Pickering (NASA); on-site liaison representative: G.B. Phillips (USPHS).

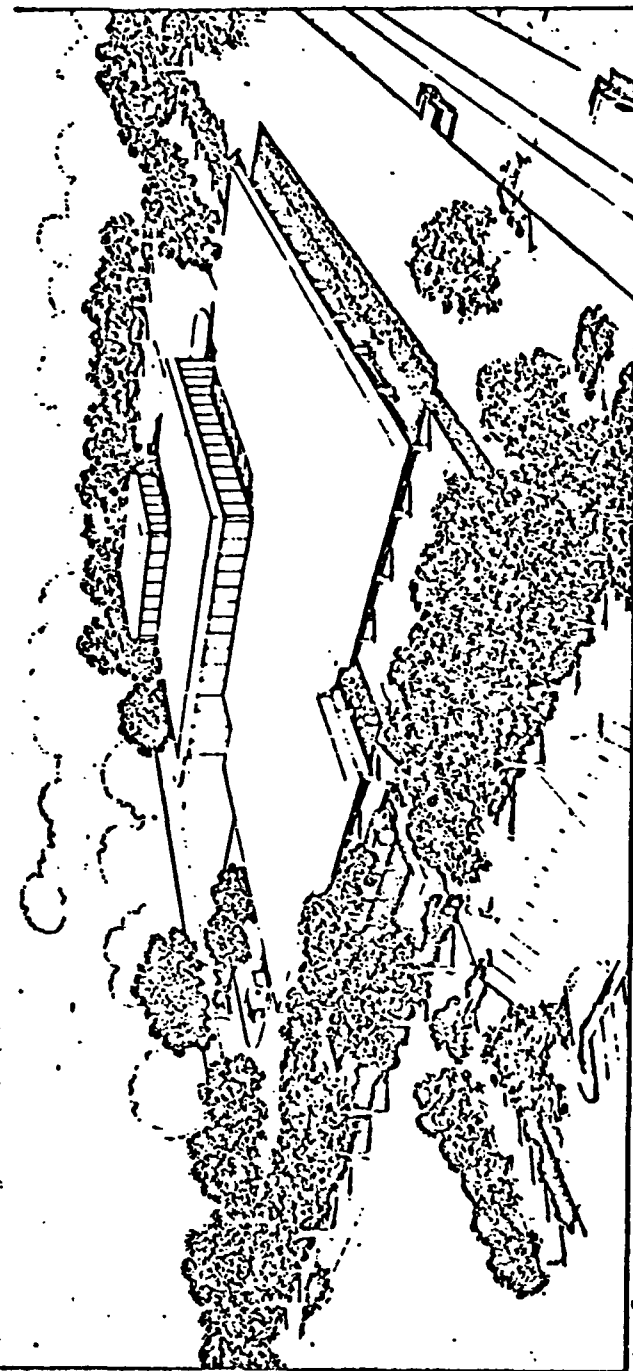

Fig. 1. Perspective drawing of the Lunar Receiving Laboratory (IRL) now under construction at NASA, Manned Spacecraft Center.

NASA  
S-65-12457

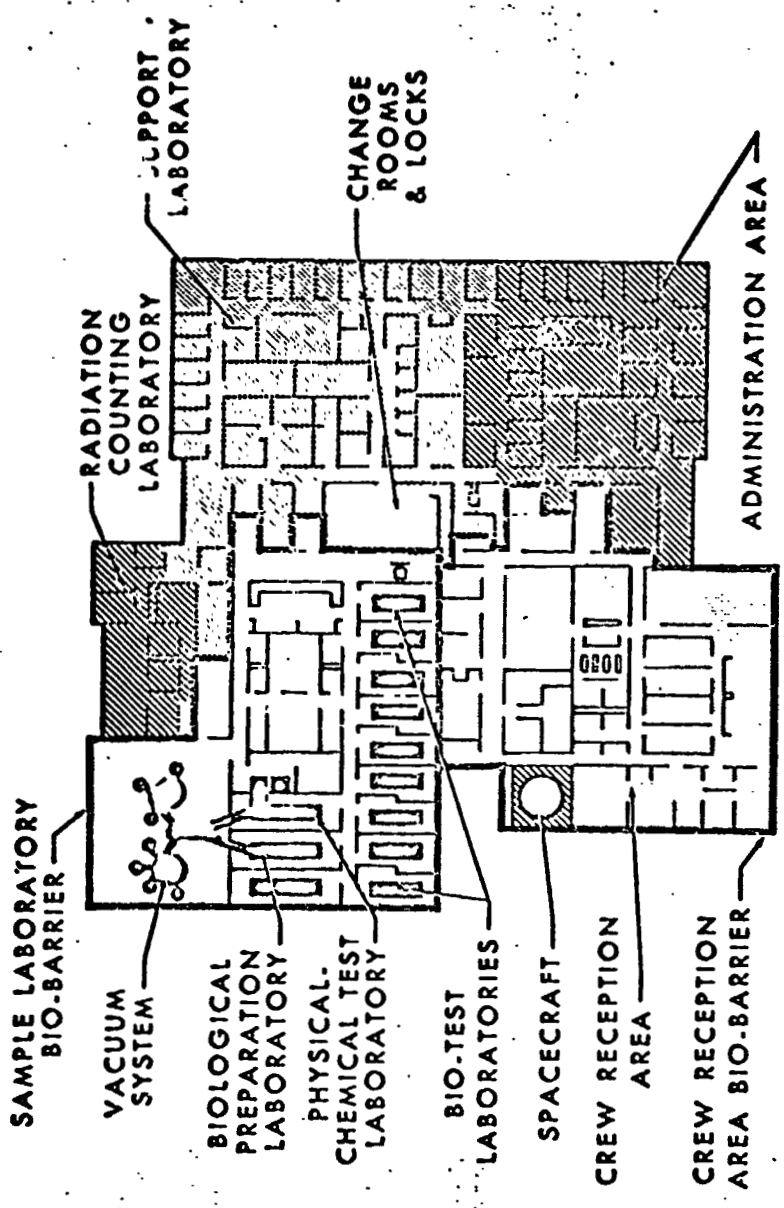

Fig. 2. Schematic floor plan of part of the IRL showing some of the major functional areas.

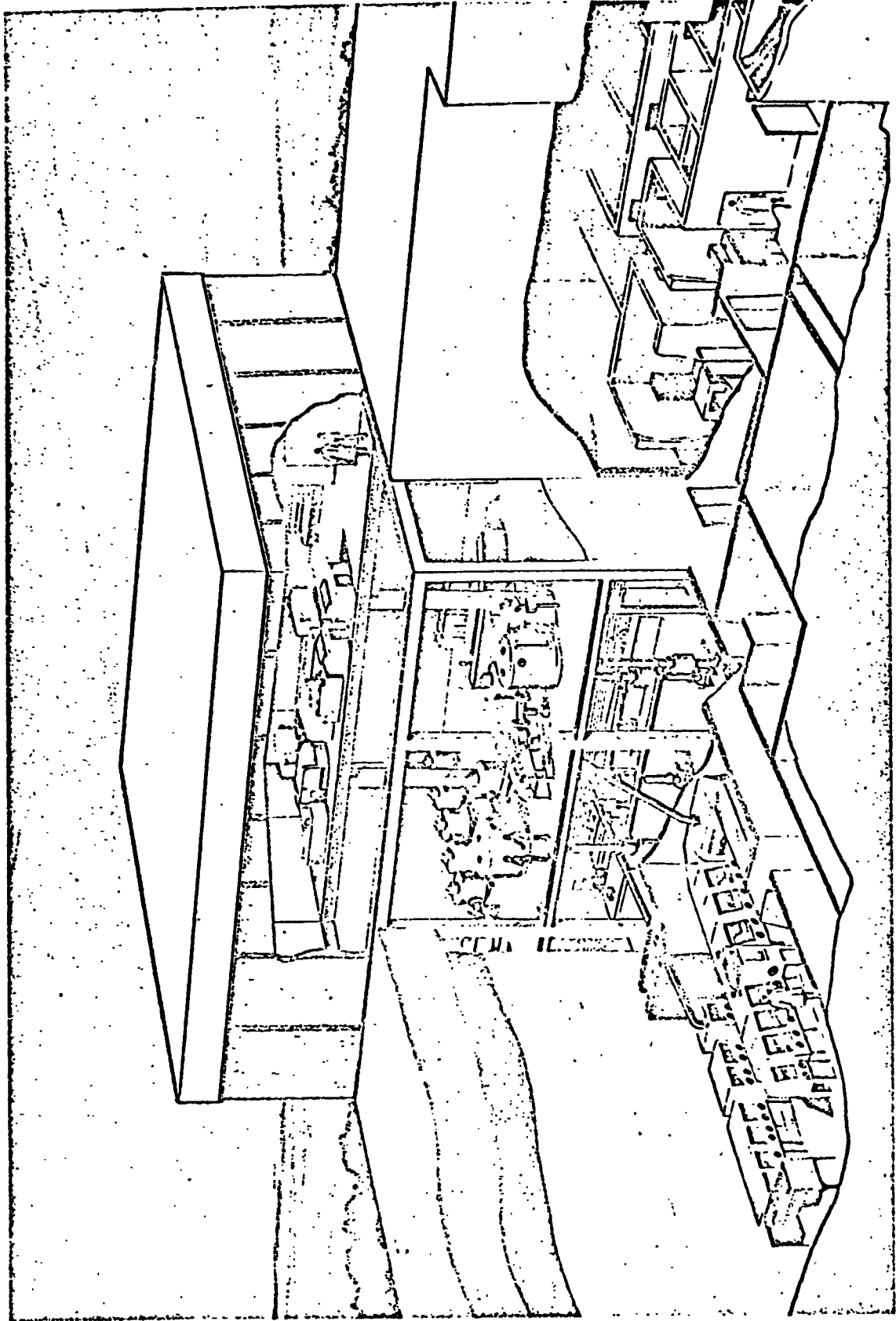

Fig. 3. Cutaway view of part of the Sample Laboratory of the IRL. The third floor area is the Gas Analysis Laboratory. The first and second floors are the Vacuum Laboratory containing the vacuum chambers, pumps, and associated control equipment. Containment cabinets in the biological preparation and physical-chemical test laboratories are shown in the foreground.

NASA  
S-68-50256

Fig. 4. Radiation Counting Laboratory. Fifteen meters below the ground floor offices is the low-level gamma-ray spectrometry laboratory. The counting room has a radiation baffle entrance and is enclosed by thick walls of low activity material. Pieces of equipment indicated in the counting room are a lead shield (left), a multiparameter pulse-height analyzer with associated electronics and accessories (center), and a detector-shield-anticoincidence mantle assembly (right).

COMPUTATION ON PROBABILITIES OF DETECTING MICROORGANISMS  
IN MASS OF LUNAR SAMPLE\*

The distributions of these microflora are considered from two probabilistic models. The first, Model I, assumes a Poisson distribution of organisms in the lunar soil. This means that, for any arbitrary amount of soil collected, there is a probability of obtaining no organisms in the sample, and also a probability of obtaining any finite number of organisms, however small. The second formulation, Model II, is nonparametric. It assumes no statistical distributions in the soil, but gives the probability, given a certain definite number of organisms in the soil, that a favorable match of organism with environment will occur, if the organisms are distributed randomly among the various environments. It is now determined that the first formulation is a limiting case of Model II, as the number of distinct types of organisms in the sample increases.

Symbols

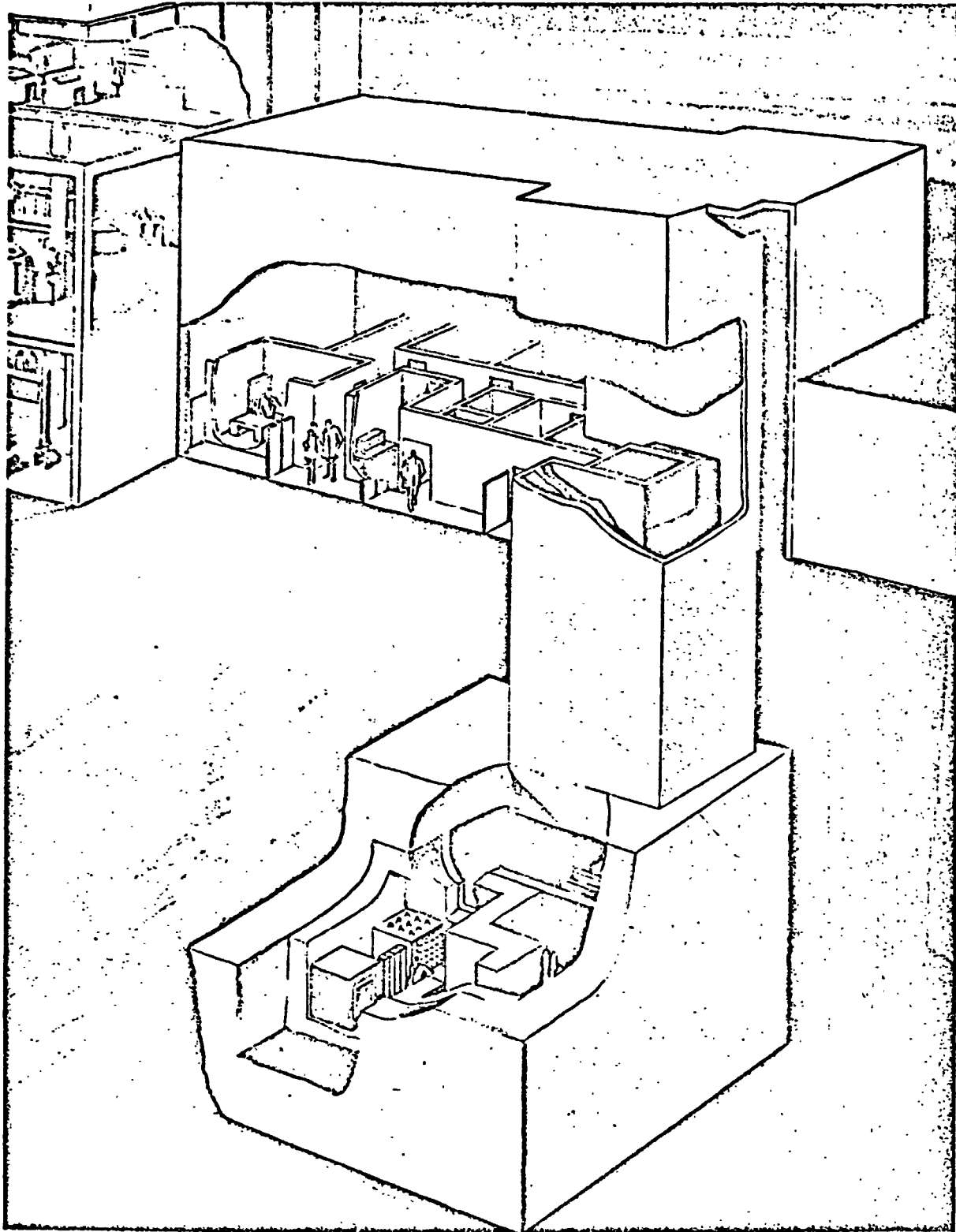
Q	Number of treatment combinations. [Number of atmospheres] [Number of temperatures] [Number of media]
M	Number of distinct types of organisms in total sample
a	Frequency of organisms of all types in sample - (organisms/gm)
W	Total weight of sample - (gms)
$f_i$	Frequency of organisms of type i
w	Weight of soil per treatment combination (gms)

\* This analysis was carried out by members of the Computation and Analysis Branch, at Ames Research Center, Moffett Field, California, under the sponsorship of Mr. Vance I. Oyama, of the Exobiology Division.



## MODEL I

## Poisson Distribution of Organisms

Prob (X organisms in a sample of weight w)

$$= \frac{e^{-aw} \cdot (aw)^x}{x!}$$

Suppose that there are M types of organism, each of frequency  $f_i$ ,  $i=1, 2, \dots, M$ , and that each of the M types can survive and grow in one and only one environment. Then,

Prob (None of the M environments has an organism which will survive and grow in it)

$$= e^{-f_1 w} \cdot e^{-f_2 w} \dots e^{-f_M w}$$

$$= e^{-w(f_1 + f_2 + \dots + f_M)}$$

where  $w = W/Q$  - total weight of sample/number of environments.

i.e., the total soil sample is divided equally among all treatment combinations (environments)

Let

P=Prob (At least one of the M environments has at least one organism in its sample which will survive in it)

$$= 1 - e^{-w(f_1 + \dots + f_M)}$$

$$= 1 - e^{-wa}$$

Where  $a$  = frequency of organisms of all kinds in the sample. Note that P is independent of the number of different kinds of organisms in the soil, but depends only on the proportion,  $a$ , of organisms of all kinds in the soil. A plot of  $2$  versus P for various values of  $a$  is shown in figure 1.

### Nonparametric Model

In this model we assume that there are  $W$  grams of material to be divided equally among the  $Q$  environments, that there are exactly a  $W$  organisms present and that the total number of ways these organisms may be distributed among the  $Q$  environments are equally likely.

Let  $n_i$  = number of organism of type  $i$  for  $i=1, 2, \dots, M$

Then the number of ways  $n_i$  organisms can be distributed among the  $Q$  environment is:

$$N_i = \binom{Q + n_i - 1}{n_i} = \left[ \frac{(Q + n_i - 1)!}{n_i! (Q - 1)!} \right]$$

and the number of ways one specified environment can be empty is:

$$K_i = \binom{Q + n_i - 2}{n_i} = \left[ \frac{(Q + n_i - 2)!}{n_i! (Q - 2)!} \right]$$

Therefore, the probability that the environment which can support organism type  $i$  is empty of type  $i$  is:

$$P_i = \frac{K_i}{N_i} = \frac{\binom{Q + n_i - 2}{n_i}}{\binom{Q + n_i - 1}{n_i}} = \frac{Q - 1}{Q - 1 + n_i}$$

Hence, the probability that all environments which can grow one of the organisms are empty is:

$$\frac{Q - 1}{Q - 1 + n_1} \cdot \frac{Q - 1}{Q - 1 + n_2} \cdot \dots \cdot \frac{Q - 1}{Q - 1 + n_M}$$

$$\frac{(Q - 1)^M}{(Q - 1 + n_1)(Q - 1 + n_2) \dots (Q - 1 + n_M)}$$

Therefore, the probability that at least one of the environments which can grow an organism is non-empty is

$$P = 1 - (Q - 1)^M / (Q - 1 + n_1) (Q - 1 + n_2) \dots (Q - 1 + n_M)$$

For ease of computation, assume that the numbers of each organism present are equal

$$n_i = n \text{ for all } i$$

Then,

$$P = 1 - \left[ \frac{Q - 1}{Q - 1 + n} \right]^M$$

now  $\sum_{i=1}^M n_i = \text{total number of organisms present}$

$$P = 1 - \left[ \frac{Q-1}{Q-1 + \frac{nM}{M}} \right]^M$$

$nM = a W$

Solving for W

$$W = \frac{M}{a} (Q - 1) \left[ \frac{1}{(1 - P)} \frac{1}{1/M} - 1 \right]$$

Dividing by Q,

$$w = \frac{W}{Q} = \frac{M}{a} \frac{(Q - 1)}{Q} \left[ \frac{1}{(1 - P)} \frac{1}{1/M} - 1 \right]$$

for large  $Q$ ,  $\frac{Q-1}{Q}$  is approximately 1, and therefore

$$w = \frac{M}{a} \left[ \frac{1}{(1-P)} \cdot \frac{1}{1/M} \right]^{-1}$$

Figures 2, 3, and 4 show  $w$  as a function of  $P$ , for various values of  $M$  and  $a$ . Note that both Models I and II show that the weight of soil per environment is independent of the number of different environments, however, the total weight of sample is, of course, not, since  $W = wQ$ .

#### Calculation for Sample Requirement

Tentative number environments considered = 108  
Probability sought = 0.95

Assumption: Poisson distribution of a frequency of 1 org/gram  
 $w = 3$  g/environment.

Then the number of grams required ( $W$ ) to detect 1 organism with a probability of 0.95.

$$W = wQ = 3 \times 108 = 324 \text{ grams}$$

Assumption: To obtain significant number of organisms for enumeration, 100 organisms will be required. Enumeration procedure will require,

$$100 \times 3 = 300 \text{ additional grams}$$

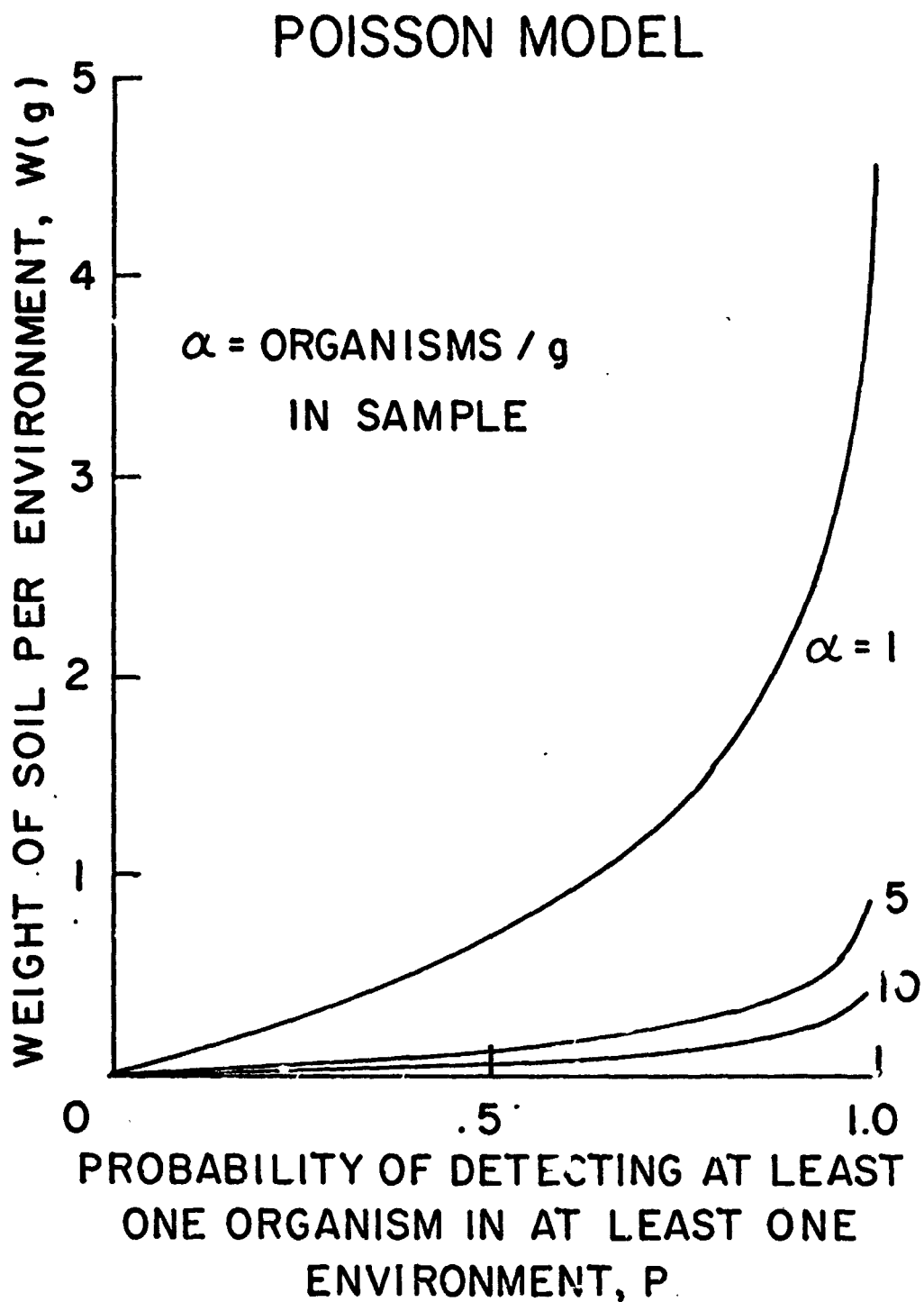

Figure 1

# NONPARAMETRIC MODEL

$$\alpha = 1$$

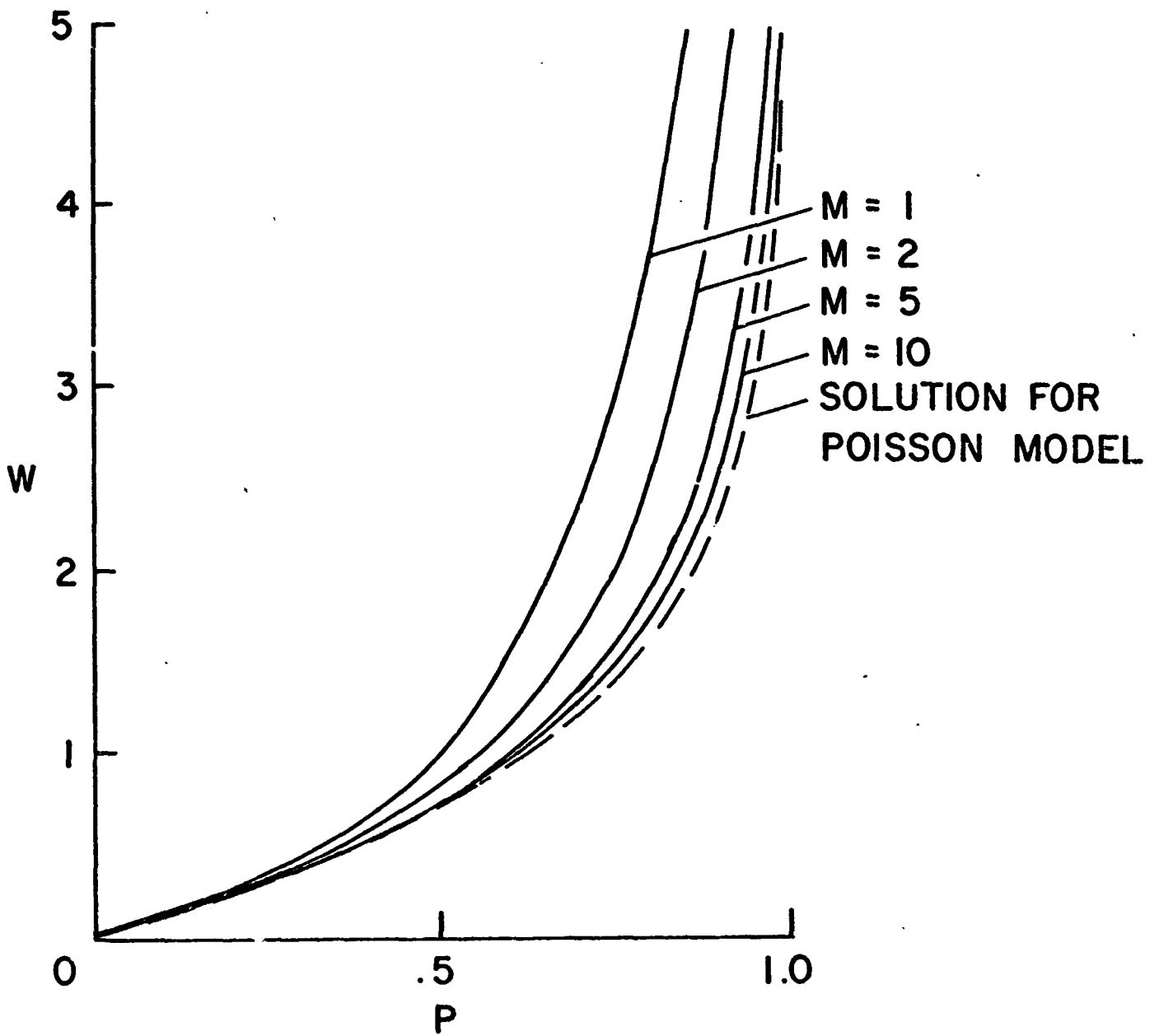

Figure 2

## NONPARAMETRIC MODEL

$$\alpha = 10$$

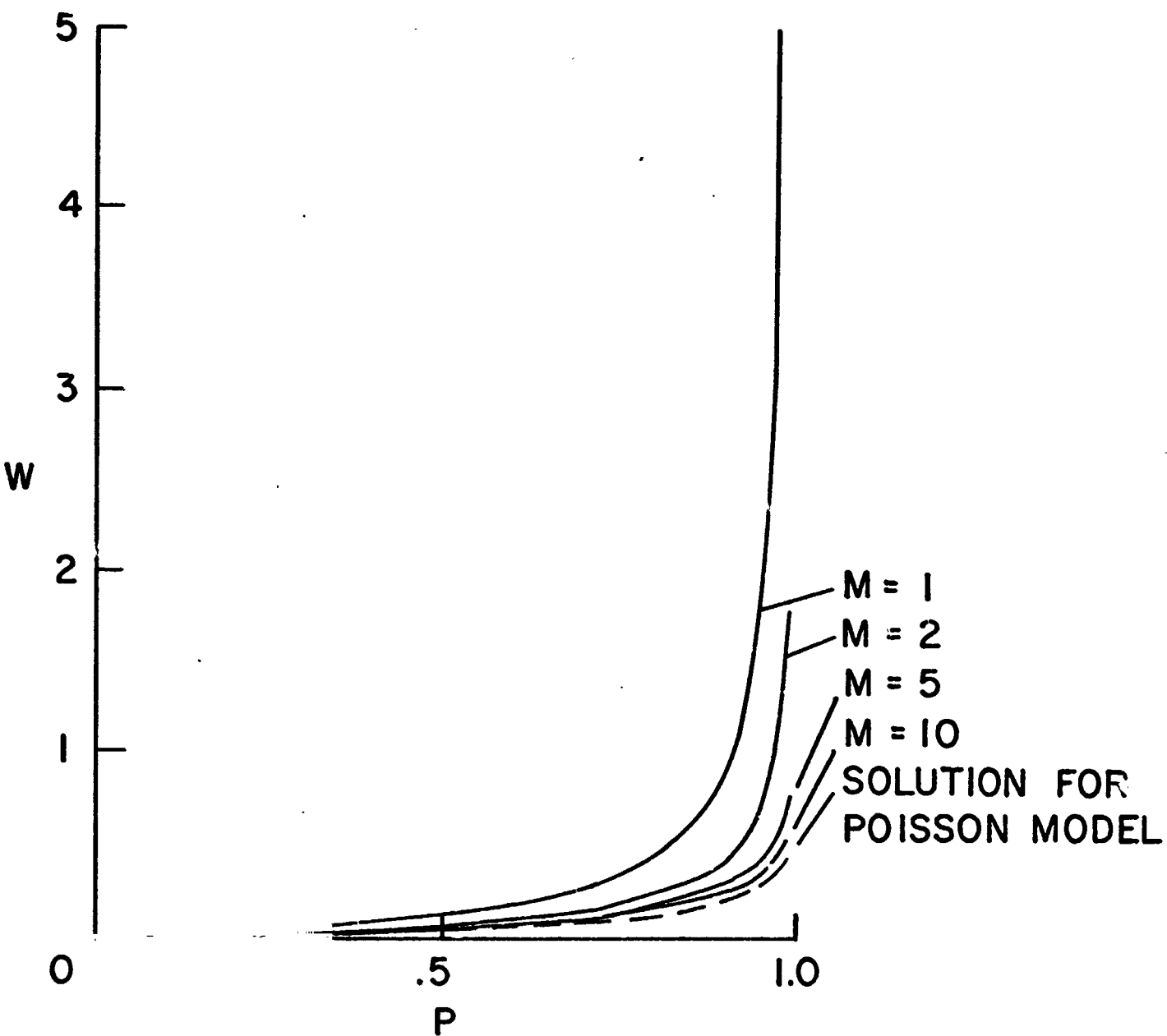

Figure 3

STANDARD METHODS FOR THE EXAMINATION OF WATER AND WASTE WATER

I. SAMPLES

A. Collection

Samples for bacteriologic examination shall be collected in bottles which have been cleansed with great care, rinsed in clean water, and sterilized as directed under "Laboratory Apparatus, Washing, and Sterilization."

B. Preservation and Storage

The bacteriologic examination of a water sample should be initiated immediately after collection. However, such a requirement is seldom practical, and more realistic arrangements must be established. Therefore, it is recommended that the technical procedures be started preferably within 1 hour after collection; the time elapsing between collection and examination should in no case exceed 30 hours.

During the period elapsing between collecting and examination, the temperature of the sample shall be maintained as close as possible to that of the source of the sample at the time of sampling.

II. STANDARD PLATE COUNT

A. Preparation and Dilution

The sample bottle shall be shaken vigorously 25 times, and the required portion shall be withdrawn at once with a standard sterile pipet to the petri dish, dilution bottle, or tube. If dilutions are made, the dilution bottle shall be likewise shaken 25 times before portions are removed.



The water used for dilution shall be prepared as directed under "Preparation of Culture Media, C, Media Modifications," Sec. 1. Tap or distilled water shall not be used.

**B. Plating**

A 1 ml, 0.1 ml, or other suitable volume of the sample or dilution to be used for plating shall be placed in the petri dish first. It is recommended that dilutions be used in preparing volumes less than 1 ml; in the examination of sewage or turbid water, a 0.1 ml inoculum of the original sample shall not be measured, but an appropriate dilution shall be prepared.

Not less than 10 ml of liquefied agar medium at a temperature of 43°C shall be added to the water in the petri dish. The agar may be stored in a melted condition in a container providing maintenance of the proper temperature for no longer than 3 hours and shall not be remelted.

Tryptone glucose extract agar (or plate count agar) shall be used.

The cover of the dish shall be lifted just enough for the introduction of the pipet or the culture medium. The agar and the sample shall be thoroughly mixed and uniformly spread over the bottom of the dish by tilting and rotating the dish.

The plates shall be solidified as rapidly as possible after pouring and placed immediately in the appropriate incubator. Not more than 20 minutes shall elapse between plating and pouring.

C. Incubation

Incubation for the standard plate count using an agar medium shall be at a temperature of  $35^{\circ} \pm 0.5^{\circ}\text{C}$  for  $24 \pm 2$  hours or at  $20^{\circ} \pm 0.5^{\circ}\text{C}$  for  $48 \pm 3$  hours. In the examination of chlorinated supplies where chlorination has not been effective and where the chlorine in the sample has been neutralized by the addition of sodium thiosulfate, coliform bacteria may not develop sufficiently to be detected in 24 hours, although in 48 hours the count may be appreciable. Glass-covered dishes and plastic dishes shall be inverted in the incubator. Plates are to be packed as directed under "Laboratory Apparatus," Sec.1. Any deviation from this method must be stated in the report of examination.

D. Counting

In preparing plates, such amounts of water shall be planted as will give from 30 to 300 colonies on a plate. The aim shall be always to have at least two plates giving the numbers between these limits, except as provided below.

Ordinarily, it is not desirable to plant more than 1.0 ml in a plate; therefore, when the total number of colonies developing from 1.0 ml is less than 30, it is obviously necessary to disregard the former rule and to record the result as observed. With this exception, only plates showing 30 to 300 colonies should be considered in determining the standard plate count. The result as reported shall be the average of all plates falling within the limits.

Counting shall be done with an approved counting aid, such as the Quebec colony counter. If such equipment is not available, counting may be done with one providing equivalent magnification and illumination.

To avoid fictitious accuracy and yet to express the numerical results by a method consistent with the precision of the technique employed, the recorded number of bacteria per milliliter shall not include more than two significant figures. For example, a count of 142 is recorded as 140, and a count of 155 is 160, whereas a count of 35 shall be recorded as 35.

Counts shall be designated as "standard plate counts at 35°C," or "standard plate count at 20°C."

### III. MULTIPLE-TUBE FERMENTATION TECHNIQUE

It has been adequately demonstrated that, even after the prescribed shaking, the distribution of bacteria in water is irregular. It is entirely possible to divide a given volume of water into portions and after testing find that the number of organisms in any portion may be none, or at least less than the arithmetic average based on examination of the total volume might indicate. It is also quite probable that the growth in a fermentation tube may result not from one but from many organisms. It is reasonable, however, to assume that growth develops from a single individual.

It is convenient to express the results of the examination of replicate tubes and dilutions in terms of "most probable number." This term is actually an estimate based on certain probability formulas.

Theoretical considerations and large-scale replicate determinations indicate that this estimate tends to be greater than the actual number, and that this disparity tends to diminish with increasing numbers of tubes in each dilution examined.

The accuracy of any single test will depend, then, on the number of tubes used. The most satisfactory information will be obtained when the largest portion examined shows gas in some or all of the tubes, and the smallest portion shows no gas in all or a majority of the tubes. The numerical value of the estimation of the bacterial content is largely determined by that dilution which shows both positive and negative results. The number of portions, especially in the critical dilution, will be governed by the desired accuracy of the result. The increased interest in and the numerous investigations into the precision of the multiple-tube technique and the expression of the results as MPN should not be permitted to confuse the issue to the extent that these methods are regarded as a statistical exercise rather than a means of estimating the coliform density of a water and thereby aiding in establishing its sanitary quality. The best assessment of such quality still must depend on the interpretation of the results of the multiple-tube technique or of other methods, possibly more precise, which may be developed and of all other information regarding a water which may be obtained, by surveys or otherwise.

A. Water of drinking-water quality

When examining water for evidence of acceptability under the standards of the US Public Health Service, only media and methods

specified in the latest edition of those standards may be used.

It is necessary to use a minimum of five fermentation tubes of the chosen presumptive medium, each containing 10 ml or 100 ml of the water sample.

B. Water of other than drinking-water quality

In the examination of waters of other than drinking-water quality, a series of lactose broth or lauryl tryptose broth tubes should be inoculated with decimal quantities of the water, the selection of the size of the portions depending on the probable coliform density as indicated by the experience of the bacteriologist and the extent of knowledge of the character of the water. The object of the examination of nonpotable water is generally to estimate the density of bacterial contamination or determine a source of pollution. This definitely requires a numerical value for reporting results. The multiple-tube fermentation technique may be used, but to obtain statistically valid MPN values a minimum series of three, but preferably five tubes, each inoculated with decimal quantities of samples, should be made. A sufficient number of samples must be examined to yield representative results for the sampling station. Generally, the log average or median value of the results of a number of samples will be a value in which the effect of individual extreme values is minimized. The membrane filter technique may prove the better procedure to accomplish this objective, although in many wastes and polluted waters the membrane filter technique may not be applicable and the multiple-tube technique will be required, as discussed under the membrane

filter technique.

#### IV. STANDARD TESTS

##### A. Presumptive test

Lactose broth or lauryl tryptose broth may be used in the Presumptive Test.

##### 1. Procedure

- a. Inoculate a series of fermentation tubes ("primary" fermentation tubes) with appropriate graduated quantities (multiples and submultiples of 1 ml) of the water to be tested. The concentration of nutritive ingredients in the mixture of medium and added portion of sample must conform to the requirements given under "Media Specifications, C," Sec. 2, 3, and 4. The portions of the water sample used for inoculating the lactose broth fermentation tubes will vary in size and number with the character of the water under examination, but in general should be decimal multiples and submultiples of 1 ml. These should be selected in accordance with the above discussion of the multiple-tube test.
- b. Incubate the fermentation tubes at  $35^{\circ} \pm 0.5^{\circ}\text{C}$ . Examine each tube at the end of  $24 \pm 2$  hours and, if no gas has formed, again at the end of  $48 \pm 3$  hours. Record the presence or absence of gas formation at each examination of the tubes, regardless of the amount. More detailed records of the amount of gas formed, though desirable for the purpose of study, are not necessary for performing the standard tests

prescribed.

## 2. Interpretation

Formation within  $48 \pm 3$  hours of gas in any amount in the inner fermentation tubes constitutes a positive Presumptive Test.

The appearance of an air bubble must not be confused with actual gas production. If the gas formed is a result of fermentation, the broth medium will become cloudy and active fermentation may be shown by continued appearance of small bubbles of gas throughout the medium outside of the inner fermentation tube when gently shaken.

The absence of gas formation at the end of  $48 \pm 3$  hours of incubation constitutes a negative test. An arbitrary limit of 48 hours for observation doubtless excludes from consideration occasional members of the coliform group which form gas very slowly; but for the purpose of a standard test based on the definition of the coliform group, exclusion of these occasional slow gas-forming organisms is satisfactory.

### B. Confirmed test

The use of confirmatory brilliant green lactose bile broth fermentation tubes or of Endo or eosin methylene blue agar plates is permitted.

#### 1. Procedure

Submit all primary fermentation tubes showing any amount of gas at the end of 24-hr incubation to the Confirmed Test.

If active fermentation appears in the primary fermentation tube before the expiration of the 24-hr period of incubation, it is preferable to transfer to the confirmatory medium without waiting for the full 24-hr period to elapse. If additional primary fermentation tubes show gas production at the end of 48-hr incubation, these too shall be submitted to the Confirmed Test.

2. Alternative procedure

Where three or more multiple portions of a series of three or more decimal dilutions of a given sample are planted, submit to the Confirmed Test all tubes of the two highest dilutions (smallest volumes) of the original samples showing gas formation in 24 hours.

All tubes producing gas in 24 hours that have not been submitted to the Confirmed Test must be recorded as containing organisms of the coliform group, even though all the Confirmed Tests made yield negative results.

Submit the Confirmed Test all tubes of all dilutions of the original sample in which gas is produced only at the end of 48 hours.

If less than three portions of any dilution (volume), or if a series of less than three decimal dilutions of the original sample are planted, submit all tubes producing gas at 24 or 48 hours to the Confirmed Test.

3. Procedure with brilliant green lactose bile broth



- a. Use a sterile metal loop 3 mm in diameter to transfer one loopful of medium from the primary fermentation tube showing gas to a fermentation tube containing brilliant green lactose bile broth. When making such transfers, gently shake the tube first or mix by rotating.
- b. Incubate the inoculated brilliant green lactose bile broth for  $48 \pm 3$  hours at  $35^{\circ}\text{C} \pm 0.5^{\circ}\text{C}$ .
- c. Interpretation

The formation of gas in any amount in the inverted vial of the brilliant green lactose bile broth fermentation tube at any time within  $48 \pm 3$  hours constitutes a positive Confirmed Test.

4. Procedure with Endo or eosin methylene blue agar plates
  - a. Streak one or more plates from each of the selected primary fermentation tubes showing gas formation; it is essential that the plates be so streaked as to insure the presence of some discrete colonies, separated by at least 0.5 cm from one another. Careful attention to the following details, when streaking plates, will result in a high proportion of successful isolation if coliform organisms are present:
    - (1) Employ an inoculating needle slightly curved at the tip.
    - (2) Tap and incline the primary fermentation tube to avoid picking up any membrane or scum on the needle.
    - (3) Insert the end of the needle into the liquid in the tube

to a depth of approximately 5.0 mm.

- (4) Streak the plate by bringing only the curved section of the needle in contact with the agar surface, so that the latter will not be scratched or torn.
- b. Incubate the plate (inverted, if with glass cover) at  $35^{\circ}\text{C} \pm 0.5^{\circ}\text{C}$  for  $24 \pm 2$  hours.
- c. Interpretation

The colonies developing on Endo or eosin methylene blue agar may be described as:

- (1) Typical- nucleated, with or without metallic sheen
- (2) Atypical- opaque, un-nucleated mucoid after 24-hr incubation, pink
- (3) Negative- all others

If typical coliform colonies have developed on the plate within the incubation period of  $24 \pm 2$  hours, the result of the Confirmed Test may be considered positive.

If only atypical colonies have developed within  $24 \pm 2$  hours, the result cannot yet be considered definitely negative, because many coliform organisms fail to form typical colonies on Endo or eosin methylene blue plates, or the colonies develop slowly. In such a case it is always necessary to complete the test as directed in Sec. 3 below.

If no colonies, or only noncoliform type colonies, have developed within  $24 \pm 2$  hours, the results of the

Confirmed Test may be considered negative.

C. Completed test

The Completed Test is used as the next step following the Confirmed Test. It may be applied to the brilliant green lactose bile broth fermentation tubes showing gas in the Confirmed Test, or to typical or atypical colonies found on the plates of solid differential medium used for the Confirmed Test.

1. Procedure

- a. If the brilliant green lactose bile broth tubes used for the Confirmed Test are to be employed for the Completed Tests, streak one or more Endo or eosin methylene blue plates from each tube showing gas as soon as possible after the appearance of gas. Incubate the plates at  $35^{\circ}\text{C} \pm 0.5^{\circ}\text{C}$  for  $24 \pm 2$  hours.
- b. From each of these plates, or from each of the plates used for the Confirmed Test (Sec 2), take one or more typical coliform colonies or, if no typical colonies are present, take two or more colonies considered most likely to consist of organisms of the coliform group, transferring each to a lactose broth fermentation tube or a lauryl tryptose broth fermentation tube and to a nutrient agar slant. The use of a colony counter is recommended to provide optimum magnification to assist in taking colonies from the plates of selective medium. When transferring

colonies, take care to choose, if possible, well-isolated colonies separated by at least 0.5 cm from other colonies, and to touch barely the surface of the colony with the needle in order to minimize the danger of transferring a mixed culture. The agar slants and secondary broth tubes incubated at  $35^{\circ}\text{C} \pm 0.5^{\circ}\text{C}$  for  $24 \pm 2$  or  $48 \pm 3$  hours, and Gram-stained preparations (see Sec. 4) from those corresponding to the secondary lactose broth tubes that show gas are examined microscopically.

## 2. Interpretation

The formation of gas in the secondary lactose broth tube and the demonstration of Gram-negative, nonspore-forming, rod-shaped bacteria in the agar culture may be considered a satisfactory Completed Test, demonstrating the presence of a member of the coliform group in the volume of sample examined.

If, after  $48 \pm 3$  hours, gas is produced in the lactose and no spores on the slant, the test may be considered "completed" and the presence of coliform organisms demonstrated.

## D. Gram stain technique

The Completed Test for coliform group organisms includes the determination of Gram-stain characteristics of the organisms isolated, as discussed above.

According to the American Society for Microbiology:

A word of caution is necessary as to the interpretation of the Gram stain. The test is often regarded with unjustified finality because organisms are generally

described as being either Gram-positive or Gram-negative. Many organisms, however, actually are Gram-variable. Hence, one should never give the Gram reaction of an unknown organism on the basis of a single test. He should repeat the procedure on cultures having different ages and should use more than one staining technique in order to determine the constancy of the organism toward the stain.

There are a large variety of modifications of the Gram stain, many of which have been listed by Hucker and Conn. The following modification by Hucker is valuable for staining smears of pure cultures.

1. Reagents

a. Ammonium oxalate-crystal violet

Dissolve 2 g crystal violet (85 per cent dye content) in 20 ml 95 per cent ethyl alcohol; dissolve 0.2 g ammonium oxalate monohydrate in 20 ml distilled water; mix the two solutions, ordinarily in equal parts. It is sometimes found, however, that this gives so concentrated a stain that Gram-negative organisms do not properly decolorize. To avoid this difficulty, the crystal violet solution may be diluted as much as ten times and the diluted solution mixed with an equal quantity of ammonium oxalate solution.

b. Lugol's solution, Gram's modification

Dissolve 1 g iodine crystals and 2 g potassium iodide in 300 ml distilled water.

c. Counterstain

Dissolve 2.5 g safranin dye in 100 ml 95 per cent ethyl

alcohol. Add 10 ml of the alcoholic solution of safranin to 100 ml distilled water.

d. Ethyl alcohol

95 per cent

2. Procedure

Stain the smear for 1 minute with the ammonium oxalate-crystal violet solution. Wash the slide in water; immerse in Lugol's solution for 1 minute.

Wash the stained slide in water; blot dry. Decolorize with ethyl alcohol for 30 seconds, using gentle agitation. Blot and cover with counterstain for 10 seconds; then wash, dry, and examine as usual.

Cells which decolorize and accept the safranin stain are Gram-negative. Cells which do not decolorize but retain the crystal violet stain are Gram-positive.

E. Test for section I coliform group (fecal coliform)

Elevated temperature tests for the separation of organisms of the coliform group of fecal origin from those derived from nonfecal sources have been used in many parts of the world and with various modifications. Recent modifications in technical procedures, standardization of methods, and detailed studies of the coliform group found in various warm-blooded animal feces compared with the coliform group from other environmental sources have established the value of elevated temperature confirmatory test procedures to indicate the fecal or nonfecal origin of the strains. The

two following procedures yield adequate information as to the fecal or nonfecal source of the coliform group when used as a confirmatory test procedure. These procedures cannot be used in the primary isolation (presumptive test method) for the coliform group. They are applicable to a positive standard presumptive test or coliform colony from solid medium.

Elevated temperature tests for differentiation of coliforms are applicable to evaluation of pollution in raw water sources for treatment procedures, estimation of pollution in streams and surface waters; interpretation of questionable coliform data which has doubtful significance, and for special investigations. It is not recommended for examination of untreated water supplies being considered for potable water.

1. Fecal coliform test (EC medium)

This procedure, used as described, may be expected to differentiate between coliforms of fecal origin (intestine of warm-blooded animal) and coliforms from other sources with a reasonable accuracy. Use EC medium as described under Media Specifications, C, Sec. 10.

a. Procedure

Inoculate a fermentation tube of medium with a 3 mm loop of broth from a positive presumptive tube and incubate in a water bath at  $44.5^{\circ} \pm 0.5^{\circ}\text{C}$  for 24 hours. Cultures from selective medium (brilliant green bile lactose broth,

membrane filter test, eosin methylene blue agar, etc.) should be inoculated in lactose broth (or lauryl tryptose broth) and incubated at 35°C until gas is produced; then proceed with inoculation of the EC fermentation tube. All EC tubes must be placed in the water bath within 30 minutes after planting.

b. Interpretation

Gas production in the fermentation tube within 24 hours or less is considered a positive reaction indicating fecal origin. Tubes which fail to produce gas (growth sometimes occurs) are a negative reaction indicating derivation from a source other than the intestinal tract of warm-blooded animals.

2. Fecal coliform test (boric acid lactose broth)

Boric acid lactose broth selectively inhibits essentially the same group of coliforms as the above described EC medium when used according to the provisions of the test procedure and can be considered reasonably accurate. Use boric acid lactose broth as described under "Media Specifications, C," Section ~~W~~.

a. Procedure

Inoculate a fermentation tube of the medium with a 3 mm loop of broth from a positive presumptive tube and incubate at  $43^{\circ} \pm 0.5^{\circ}\text{C}$  for 24-48 hours. Inoculate cultures from selective medium (brilliant green bile lactose broth, membrane filter test, eosin methylene blue agar, etc.)



in lactose broth (or methylene blue agar, etc.) and incubate at 35°C until gas is produced within 48 hours; then proceed with inoculation of the boric acid lactose broth fermentation tube. All tubes must be placed in the water bath within 30 minutes after planting.

b. Interpretation

Gas production in the fermentation tube within 48 hours is considered a positive reaction indicating fecal origin. Tubes which fail to produce gas (growth sometimes occurs) are a negative reaction indicating derivation from a source other than the intestinal tract of warm-blooded animals.

V. APPLICATION OF TESTS TO ROUTINE EXAMINATIONS

The following basic considerations apply to the selection of the Presumptive Test, the Confirmed Test, or the Completed Test in the examination of any given sample of water or waste water.

A. Presumptive test

1. Any sample of waste, sewage, sewage effluent (except chlorinated effluent), or water known to be heavily polluted, the fitness of which for use as drinking water is not under consideration.
2. Any routine sample of raw water in a treatment plant, provided records indicate the Presumptive Test is not too inclusive for the production of pertinent data.

B. Confirmed test

The Confirmed Test should be applied in the examination of:

1. Any water to which the Presumptive Test is known, from previous records, to be inapplicable.
2. Routine samples of drinking water, water in process of treatment, and finished waters.
3. Chlorinated sewage effluents.
4. Bathing water.

C. Completed test

The Completed Test should be applied in the examination of water samples where the results are to be used for the control of the quality of raw or finished waters; or, if not applied to all samples, then to such a proportion of them as to establish beyond reasonable doubt the value of the Confirmed Test in determining the sanitary quality of such water supplies.

VI. ESTIMATION OF COLIFORM GROUP DENSITY

A. Precision of fermentation tube test

It is desirable to keep in mind the fact that, unless a large number of portions of sample are examined, the precision of the fermentation tube test is rather low. For example, even when the sample contains one coliform organism per milliliter, about 37 per cent of 1 ml tubes may be expected to yield negative results because of irregular distribution of the bacteria in the sample. When five tubes, with 1 ml of sample in each, are employed under these conditions, a completely negative result may be expected less than 1 per cent of the time.

Even when five fermentation tubes are employed, the precision of the results obtained is not of a high order. Consequently, great caution must be exercised when interpreting, in terms of sanitary significance, the coliform results obtained from the use of a few tubes with each dilution of sample.

B. Computing and recording of MPN

The number of positive findings of coliform group organisms (either presumptive, confirmed, or completed) resulting from multiple-portion decimal dilution plantings should be computed and recorded in terms of the "most probable number" (MPN). The MPN for a variety of planting series and results is given in Tables 36 through 41. Included in these tables are the 95 per cent confidence limits for each MPN value determined.

The quantities indicated at the heads of the columns relate more specifically to finished waters. The values may be used in computing the MPN in larger or smaller portion plantings in the following manner: if instead of portions of 10, 1.0, and 0.1 ml, a combination of portions of 100, 10, and 1 ml is used, the MPN is recorded as 0.1 times the value in the table.

If, on the other hand, a combination of corresponding portions of 1.0, 0.1, and 0.01 ml is planted, record 10 times the value in the table; if a combination of portions of 0.1, 0.01, and 0.001 ml is planted, record 100 times the value in the table.

When more than three dilutions are employed in a decimal series of dilutions, the results from only three of these are significant.

To select the three dilutions to be employed in determining the MPN index, using the system of five tubes of each dilution as an example, the highest dilution which gives positive results in all of the five portions tested (no lower dilution giving any negative results) and the two next succeeding higher dilutions should be chosen. The results of these three volumes should then be used in the computation of the MPN index. In the examples given below, the significant dilution results are shown in bold-face (the number in the numerator represents positive tubes; that in the denominator, the total tubes planted):

	1 ml	0.1 ml	0.01 ml	0.001 ml
(a)	5/5	5/5	2/5	0/5
(b)	5/5	4/5	2/5	0/5
(c)	0/5	1/5	0/5	0/5

In c, the first three dilutions should be taken, so as to throw the positive result in the middle dilution.

When a case such as shown below, in d, arises, where a positive occurs in a dilution higher than the three chosen according to the result of the highest chosen dilution, making the result read as in e:

	1 ml	0.1 ml	0.01 ml	0.001 ml
(d)	5/5	3/5	1/5	1/5
(e)	5/5	3/5	2/5	0/5

A desirable procedure for obtaining a single MPN value for a series of samples is to express the results of the examination

of each sample in terms of its MPN value and strike a geometric average of these values. In some instances, it may be advantageous to compute an arithmetic average of the results of a series of samples in order to emphasize the significance of a single high MPN value.

#### VII. TEST FOR PRESENCE OF ENTERIC VIRUSES IN WATER AND WASTE WATER

Routine examination of water and waste water for enteric viruses is not practical at the present time. The term "enteric virus," as used herein, includes all viruses known to be excreted in quantity in the feces of man. The group includes the polioviruses, the Coxsackie viruses, the ECHO (enteric cytopathogenic human orphan) viruses, the adenoviruses and the virus(es) of infectious hepatitis. The total number of such viruses approaches 100, with new types being discovered continually.

The enteric virus group, in the broadest sense, could be utilized as indicators of fecal pollution, inasmuch as most of them appear to be infectious only for humans and are excreted in feces. However, it must be recognized that although nearly everyone discharges coliform bacteria and streptococci in feces, excretion of enteric viruses by apparently healthy persons is largely confined to individuals under 15 years of age. It has been calculated that the relative enteric virus density to coliform density in sewage is about 1 to 65,000, a ratio which makes coliform detection considerably easier than virus detection. Thus, viruses cannot at present be used as a measure of water quality, because it is possible to have fecal pollution, with

associated enteric pathogenic bacteria, in the absence of viruses. However, it is also possible to have viral agents present in the absence of bacterial indicators of pollution, inasmuch as viruses and bacteria react differently to various changes in their environment.

Because all of the enteric viruses are discharged in quantity in the feces of infected individuals, there is obvious opportunity for these agents to contaminate water sources. The detection of these agents in sewage or water thus becomes a matter of importance, and a number of techniques have been devised for this purpose. All of these techniques have been developed with the primary objective of concentrating the viruses in sewage or water to a point where they can be detected without testing impossibly large sample volumes. It is now well documented that the "swab" technique of sample collection is superior to the "grab sample" technique. Further concentration of the liquid expressed from the gauze swab is desirable. This can be accomplished by the resin or ultracentrifuge method. Available information indicates that the ultracentrifuge method is superior and yields a higher percentage of positive samples.

The examination of sewage or water for enteric viruses is still largely limited to specific research problems. Although it is relatively easy to obtain positive isolations from sewage, particularly during late summer and early fall, it is usually difficult to detect viruses in surface waters because of the dilution afforded any entering sewage. Detection of virus in these waters must await improved methods of concentrating small numbers of viruses from

relatively large volumes of water.

The sanitary and epidemiological significance of enteric viruses in water and sewage is unknown. The mere presence of a viral agent in sewage does not necessarily mean that a significant health hazard is present. A problem might be created only when the density of such agents became high enough for some to survive whatever treatment might be applied to the sewage, so that large numbers of viable organisms entered the receiving waters. These agents may gain access to the water supply of a community and, if they survive the treatment process, initiate an epidemic such as occurred with the virus of infectious hepatitis. From an epidemiological viewpoint, the qualitative demonstration of viruses in sewage could partially indicate the type of infection present in the community, not only in an epidemic, but also in a surveillance program.

Enteric viruses have not been demonstrated in treated urban water in the United States, either because they are not present or because current techniques are not sufficiently efficient to detect them. Epidemiological evidence also indicates that fully treated water is not now an important vehicle in the transmission of these agents. Increasing reuse of water may change this situation in the future.

#### VIII. OTHER INFORMATION

Laboratory apparatus, media (formulae and preparation), alternate techniques, and identification schema are also given in this chapter (VII) of Standard Methods for the Examination of Water and Wastewater, 1965, 12th Edition, American Public Health Association, New York, New York.

**MICROBIOLOGICAL REQUIREMENTS FOR SPACE FOOD PROTOTYPES****ADDENDUM NO. 1B****I. MICROBIOLOGICAL SPECIFICATIONS**

Total Aerobic Plate Count	Not Greater than 10,000/gm.
Total Coliform Count	Not Greater than 10/gm.
Fecal Coliform Count	Negative in 1 gm.
Fecal Streptococci Count	Not Greater than 20/gm.
Coagulase Positive Staphylococci	Negative in 5 gm.
Salmonellae	Negative in 5 gm.

**II. METHODOLOGY****A. Preparation of slurry**

1. Twenty-five (25) grams of the dehydrated sample are aseptically transferred to a sterile blender cup. Add 100 ml of chilled sterile distilled water and blend for three (3) minutes. (This slurry constitutes a 1:5 dilution and contains the equivalent of 0.2 gm food sample per ml. Hereafter, this shall be termed Extract A).
2. Twenty-five (25) ml aliquot of Extract A is transferred into a 25 ml chilled Sterile Buffered Water Blank (SBW: PO<sub>4</sub> M/15 pH 7.0), thoroughly mixed. (This mixture constitutes a final dilution of 1:10 and contains the equivalent of 0.1 gm, food sample per ml, the 1:10 dilution shall be termed Extract B).
3. Both extracts shall be maintained at not greater than 40°F until used as prescribed in the following tests.



**B. Total Aerobic Plate Count**

1. Eleven (11) ml aliquot of Extract B is transferred into a 99 ml SBW, giving a final dilution of 1:100.
2. One (1) ml aliquot of the 1:100 dilution is transferred into each of five (5) Petri plates and poured with "Tryptone Glucose Yeast" agar.
3. Plates are incubated at 35°C and counted after 48 hours.
4. The total number of colonies on the five (5) plates shall not exceed 500.

**C. Total Coliform Count**

1. One (1) ml aliquot of Extract B is transferred into each of ten (10) Petri plates and poured with "Violet Red Bile" agar (VRB).
2. Solidified plates are stratified with 3 to 4 ml of same agar.
3. Plates are incubated at 35°C and typical coliform colonies (dark red, 0.5 mm or more in diameter) are counted after 18 to 24 hours.
4. The total number of typical colonies on all ten (10) plates shall constitute the "Total Coliform Count" per 1.0 gm of test food and shall not exceed ten (10).

**D. Fecal Coliform Count**

1. From each typical VRB Colony (see para B) a transfer is made into a Phenol Red Lactose Broth fermentation tube.
2. Incubate at 35°C for 18 to 24 hours.
3. Transfer 2 loopfuls (3 mm diameter) of broth from each tube displaying acid into an "EC" broth fermentation tube.

4. Incubate at  $45.5 \pm 0.2^{\circ}\text{C}$  for 18 to 24 hours. Both temperature and time are critical for this differential test. Hence, incubation shall be carried out in a constant-temperature water bath, monitored with a certified Bureau of Standards thermometer or equivalent. Incubation time shall not exceed 24 hours. "EC" tubes displaying gas production are considered positive for "Fecal Coliforms." A single "EC-positive" colony shall constitute rejection.
5. Where merited, the analyst may further confirm the EC-positive culture for the Escherichia coli type through the establishment of their IMVIC pattern according to Standard Procedures.

#### E. Fecal Streptococci Count

1. One (1) ml aliquot of Extract B is transferred into each of ten (10) Petri plates and poured with "KF Streptococcus" agar.
2. Plates are incubated at  $35^{\circ}\text{C}$  and typical colonies (dark red or those having a red or pink center, 0.3 to 2 mm in diameter) are counted after 48 hours.
3. The total number of typical colonies on all five "KF" plates shall constitute the "Fecal Streptococci Count" per 1.0 gm test food and shall not exceed twenty (20).
4. Where merited, the analyst may further confirm the KF-positive colonies through the following methods:
  - a. Microscopic examination
  - b. Gram stain
  - c. Catalase test

#### F. Coagulase Positive Staphylococci

1. Transfer a 25 ml aliquot of Extract A into 225 ml of cooked meat medium with ten percent (10%) NaCl.
2. Incubate at 35°C for 18 to 24 hours.
3. One-tenth (1/10) ml aliquot of cooked meat medium is spread on each of five (5) plates of Tellurite Glycine Agar.
4. Plates are incubated at 35°C and examined for typical staphylococci colonies (black) at the end of 24 hours.
5. From each typical colony an inoculum is streaked on a five percent (5%) "Sheep Blood" agar plate.
6. Plates are incubated at 35°C and examined for Beta-hemolysis at the end of 48 hours.
7. Each Beta-hemolytic colony is examined for coagulase activity by the standard tube method.
8. A single coagulase positive colony shall constitute rejection.

#### G. Salmonellae

1. Transfer a 25 ml aliquot of Extract A into 225 ml of lactose broth.
2. Incubate at 35°C for 6 hours.
3. Transfer a 25 ml aliquot of lactose broth into 225 ml of each of Selenite-Cystine and Tetrathionate broths.
4. Incubate at 35°C for 18 to 24 hours.
5. From each enrichment culture, a loopful is streaked on each of two (2) plates of each of three (3) selective media: Brilliant Green (BG) agar, Bismuth Sulfite (BS) agar and Salmonellae-Shigellae (SS) agar.

6. BG and BS plates are incubated for 24 hours and SS plates for 48 hours at 37°C.
7. From each suspect colony on any of the plates an inoculum is stabbed and streaked on "Triple Sugar Iron" agar (TSI) slant, and streaked on "Christenson's Urea" agar (CU) slant.
8. Slants are incubated at 37°C for 24 hours.
9. CU slants are observed periodically for 4 to 6 hours. If culture shows a urea-positive reaction (reddening of agar) the respective colony is Salmonellae negative and test is ended. Otherwise, slants are incubated for the full 24 hours.
10. Positive TBI (Acid butt, alkaline slants, with and without gas and H<sub>2</sub>S) associated with urea-negative reaction shall constitute a positive Salmonellae culture.
11. Transfers from positive TSI slants are typed against salmonellae poly-valent serum. Positive reaction constitutes confirmed presumptively positive salmonellae in the test sample.
12. Presumptively positive TSI slants are confirmed through reaction in the following:
  - a. Lactose, sucrose, dulcitol, mannitol broths.
  - b. Lysine decarboxylase broth
  - c. KCN broth
  - d. Indole broth
13. A single confirmed positive Salmonellae culture shall constitute rejection.

### III. REFERENCES

Recommended Methods for the Microbiological Examination of Foods 1958, American Public Health Association, Inc., 1790 Broadway, New York, N.Y., 10019.

Examination of Foods for Enteropathogenic and Indicator Bacteria, U.S. Department of Health, Education and Welfare, Washington, D.C., 20201.

Fishbein, M., 1962, The Aerogenic Response of Escherichia coli and Strains of Aerobacter in EC Broth and Selected Sugar Broths at Evaluated Temperatures. *Applied Microbiology* 10:79-85.

Fishbein, M., and Surkiswicz, B.F., 1964, Comparison of the Recovery of Escherichia coli from Frozen Foods and Nutmeats by Confirmatory Incubation in EC Medium at 44.5 and 45.5°C, *Applied Microbiology* 12:127-31.

Standard Methods for the Examination of Water and Wastewater, Eleventh Edition, 1960, American Public Health Association, Inc., 1790 Broadway, New York, N.Y., 10019.

Hall, H.E., Brown, D. F. and Angelottic, R., 1963, the Recovery of Enterococci from Food Using KF Streptococcus Media, *J. Food Science* 28, 566-571.

Production Guide, 1965. U.S. Army Natrick Laboratories, Natrick, Mass.

TECHNIQUE FOR THE FLUORESCENT TREPONEMAL ANTIBODY-  
ABSORPTION (FTA-ABS) TEST

I. REAGENTS

A. Antigen

1. Fresh antigen extract

Treponema pallidum, Nichols strain, shall be extracted from rabbit testicular tissue, in basal medium, as recommended for the Treponema pallidum Immobilization (TPI) test. (See pages 71-74 of "Manual of Serologic Tests for Syphilis," 1964.) This suspension shall contain approximately 50 organisms per microscopic field, at a 450 X magnification. This is the antigen for the FTA test and may be stored, without added preservative, at 6° to 10°C. If antigen becomes bacterially contaminated, it shall be discarded.

2. Lyophilized antigen extract

Antigen shall be prepared as in 1. This preparation shall be preserved by freeze-drying,<sup>1</sup> reconstituted with sterile distilled water, according to directions, and stored at 6° to 10° C. A satisfactory reconstituted antigen shall contain a minimum of 30 organisms per high dry field in the liquid state. There shall be sufficient numbers of organisms remaining on the slide after staining to enable one to read the test without difficulty.

---

<sup>1</sup>Baltimore Biological Laboratory, Baltimore, Md. 21218, Difco Laboratories, Detroit, Mich. 48201, and The Sylvania Co., Millburn, N.J.

B. FTA-ABS test sorbent<sup>2</sup>

A standardized extract of the nonpathogenic Reiter treponeme containing group treponemal antigens shall be used.

1. Lyophilized sorbent

Lyophilized sorbent shall be rehydrated with distilled water according to the accompanying directions.

2. Stock sorbent

Stock sorbent shall be stored in convenient quantities at  $-20^{\circ}$  C. When thawed for use, it can be stored at  $6^{\circ}$  to  $10^{\circ}$  C for a period of one week.

C. Fluorescein-labeled antihuman globulin<sup>3</sup> (conjugate) of proven quality. Stock conjugate shall be stored in convenient quantities at  $-20^{\circ}$  C. When thawed for use, it shall not be refrozen but stored at  $6^{\circ}$  to  $10^{\circ}$  C for a period of one week.

D. Phosphate buffered saline<sup>4</sup>

Formula per liter:

NaCl .....	7.65 g
Na <sub>2</sub> HPO <sub>4</sub> .....	0.724 g
KH <sub>2</sub> PO <sub>4</sub> .....	0.21 g

---

<sup>2</sup>Difco Laboratories, Detroit, Mich. 48201.

<sup>3</sup>Baltimore Biological Laboratory, Baltimore, Md. 21218, Difco Laboratories, Detroit, Mich. 48201, and The Sylvana Co., Millburn, N.J.

<sup>4</sup>Difco Laboratories, Detroit, Mich. 48201 (Bacto Hemagglutination Buffer No. 0512).

This solution yields pH meter readings of pH  $7.2 \pm 0.10$ . It shall be stored in a large polyethylene bottle.

E. Tween-80<sup>5</sup>

A solution of 2-percent Tween-80 in phosphate buffered saline shall be prepared by heating the two reagents in a  $56^{\circ}$  C water bath. Measuring from the bottom of a pipette, add 2 ml of Tween-80 to 98 ml saline and rinse out the pipette in the solution. This solution keeps well at refrigerator temperature but should be discarded if a precipitate develops.

F. The mounting medium shall consist of 1 part buffered saline plus 9 parts glycerine (reagent quality).

G. A.C.S. acetone shall be used.

## II. PRELIMINARY TESTING

### A. Preliminary Testing of Treponema Pallidum Antigen Suspension

1. The antigen suspension shall be well mixed with a disposable pipette and rubber bulb, drawing the suspension into and expelling from the pipette 8 to 10 times, to break the treponemal clumps and insure an even distribution of treponemes. It shall be determined by darkfield examination that the treponemes are adequately dispersed before making slides for FTA test. Additional mixing may be required.
2. A new lot of antigen\* shall be compared with an antigen of known reactivity before being incorporated into the regular test procedure. Comparable test results shall be obtained on control serums and individual serums of graded reactivity. (See Controls, part IV)

---

<sup>5</sup>Z. D. Gilman, Inc., 627 Pennsylvania Ave., N. W., Washington, D.C.

\*Some antigens satisfactory for use in the FTA-200 test are not suitable for use in the FTA-ABS test.



3. A satisfactory antigen preparation shall not stain directly or non-specifically with a known conjugate at its established titer.

#### B. Preliminary Testing of FTA-ABS Test Sorbent

1. A new lot of sorbent shall be compared with a sorbent of known activity before being incorporated into the regular test procedure.
  - a. Testing shall be performed using control serums, individual serums of graded reactivity, and nonsyphilitic serums demonstrating non-specific reactivity (group antibody).
  - b. Comparable test results shall be obtained with both sorbents.
  - c. Nonspecific staining controls a. and b. shall be Nonreactive.  
(See Controls, part IV)

#### C. Preliminary Testing of Fluorescein-Labeled Antihuman Globulin

1. The titer of each new lot of conjugate shall be determined, using the particular darkfield fluorescence microscope assembly available, before being used in routine testing.
2. The following dilutions of the unknown conjugate in phosphate buffered saline containing 2-percent Tween-80 shall be prepared:  
1:10, 1:20, 1:40, 1:80, 1:160  
Higher dilutions may be prepared if necessary.
3. Each conjugate dilution shall be tested with a Reactive (4+) control serum.
4. A nonspecific staining control shall be run with undiluted and each dilution of unknown conjugate. (See Controls, part IV, step 4a.)
5. A known conjugate, at its titer, shall be set up at the same time with the Reactive (4+) control serum, a Reactive (2+) control serum, and

nonspecific staining control.

Example of titration of unknown conjugate				
Conjugates	Controls	Nonspecific staining control	Reactive (4+) control serum	Reactive (2+) control serum
Known conjugate titer 1:40		-	4+	2+
Unknown conjugate dilution:				
undiluted		- to ±	4+	
1:10		-	4+	
1:20		-	4+	
1:40		-	4+	
1:80		-	4+	
1:160		-	2+	

6. The titer of the conjugate selected for use shall be that dilution which is one doubling dilution lower than the highest dilution giving maximum fluorescence (4+). In the dilution selected for use it is 1:40.
7. A satisfactory conjugate shall not stain an antigen of known quality directly or nonspecifically at a dilution of 1:10 or higher and, when undiluted, should not show more than a ± intensity of fluorescence.
8. Each new lot of conjugate shall be tested in parallel with a known conjugate before being incorporated into the regular test procedure. Testing shall be performed using control serums and individual serums of graded reactivity. Comparable test results shall be obtained with both conjugates.

### III. PREPARATION OF SERUMS

Note: Bacterial contamination or excessive hemolysis may render specimens unsatisfactory for testing.

- A. Test and control serums shall be heated at 56° C for 30 minutes before being tested.
- B. Previously heated serums shall be reheated for 10 minutes at 56° C on the day of testing.

### IV. CONTROLS

Control serums shall be used and stored according to directions. The undiluted serum shall be heated. The following controls must be included in each test run and shall be performed in duplicate:

#### A. Reactive (4+) control:

Reactive serum or a dilution of Reactive serum<sup>6</sup> demonstrating strong (4+) fluorescence when diluted 1:5 in saline and only slightly reduced fluorescence when diluted 1:5 in sorbent shall be used.

1. Using a 0.2 ml pipette, measuring from the bottom, 0.05 ml of Reactive control serum shall be added to a tube containing 0.2 ml of phosphate buffered saline. This shall be mixed well (at least 8 times).
2. Using a 0.2 ml pipette, measuring from the bottom, 0.05 ml of Reactive control serum shall be added to a tube containing 0.2 ml of sorbent. This shall be mixed well (at least 8 times).

#### B. Reactive (2+) control:

A dilution of Reactive serum<sup>6</sup> demonstrating 2+ fluorescence shall

---

<sup>6</sup>Baltimore Biological Laboratory, Baltimore, Md. 21218, Difco Laboratories, Detroit, Mich. 48201, and The Sylvana Co., Millburn, N.J.

be used.

Reactive serum shall be diluted in phosphate buffered saline according to previously determined dilution factor.

C. Nonspecific serum controls:

A nonsyphilitic serum known to demonstrate at least 2+ nonspecific reactivity in the FTA test at a dilution in saline of 1:5 or higher shall be used.

Using a 0.2 ml pipette, measuring from the bottom, 0.05 ml of nonspecific serum shall be added to a tube containing 0.2 ml of phosphate buffered saline. The solution shall be mixed well (at least 8 times).

D. Nonspecific staining controls:

1. Antigen smear treated with 0.03 ml saline followed by diluted conjugate shall be used as a control.
2. Antigen smear treated with 0.03 ml of sorbent followed by diluted conjugate shall be used as a control.

Note: Controls #1, #3, and #4 are included for the purpose of controlling reagents and test conditions. Control #2 (reactive (2+) control serum) is included as the reading standard.

## V. TESTING

### A. Fluorescent Treponemal Antibody-Absorption (FTA-ABS) Test with Serum

1. On clean slides, two circles 1 cm in diameter shall be cut.<sup>7</sup> Slides shall be wiped with clean gauze to remove loose glass particles.
2. 0.005 ml or one loopful of *Treponema pallidum* antigen shall be smeared evenly within each circle, using a standard 2-mm, 26-gage, platinum

---

<sup>7</sup>See footnote 2, page 2

- wire loop. These shall be air dried at least 15 minutes.
3. Slides shall be immersed in or covered with acetone<sup>8</sup> for 10 minutes, removed and allowed to dry thoroughly. Acetone-treated slides may be stored at  $-20^{\circ}$  C. These fixed slides are usable indefinitely, provided satisfactory results are obtained with controls.
  4. Slides shall be identified by numbering the frosted end with a lead pencil, using a separate slide for each control and each serum.
  5. 12 x 75 mm test tubes shall be arranged in wire racks so that there is one tube for each serum to be tested, plus the Reactive (2+) control, and two tubes each for the Reactive (4+) control and non-specific control serum. The tubes shall be numbered to correspond to the serums and control serums being tested.
  6. Reactive (4+), Reactive (2+), and nonspecific control serum dilutions shall be made in saline and/or sorbent according to the directions (see Controls, part IV).
  7. For each test serum, 0.2 ml of sorbent shall be pipetted into a test tube.
  8. Using a 0.2 ml pipette, measuring from the bottom, 0.05 ml of the heated test serum shall be added to the appropriate tube and immediately mixed 8 times with the same pipette. This is a 1:5 serum dilution.
  9. After preparing the serum dilutions, not more than 30 minutes shall elapse before the tests are set up. If it is necessary to test or

---

<sup>8</sup> It is recommended that no more than 50 slides be used with 200 ml of acetone.

repeat a specimen after this period, a new serum dilution shall be prepared.

10. The appropriate antigen slides shall be covered with 0.03 ml of the 1:5 test serum dilutions. Each serum shall be tested singly or in duplicate on a single slide.
11. The appropriate antigen slides shall be covered with 0.03 ml of the Reactive (4+), Reactive (2+), and nonspecific control serum dilutions.
12. The appropriate antigen slides shall be covered with 0.03 ml of the saline and sorbent for "Nonspecific staining controls a. and b."
13. Evaporation of serum dilutions shall be prevented by placing slides within a moist chamber.
14. Slides shall be placed in an incubator at 35° to 37° C for 30 minutes.
15. Rinsing procedure:
  - a. Slides shall be rinsed with running buffered saline for approximately five seconds.
  - b. They shall be soaked in two changes of buffered saline for a total of 10 minutes. At the end of each 5 minute soaking period, the slides shall be rinsed by dipping them in and out of the buffered saline 30 times.
  - c. This shall be followed with a brief rinse of running distilled water to remove the salt crystals.
16. The slides shall be gently blotted with bibulous paper to remove all water drops.
17. Just prior to use, the conjugate shall be diluted to its working titer in phosphate buffered saline containing 2-percent Tween-80.

18. Approximately 0.03 ml of diluted conjugate shall be placed on each smear.
19. Steps 13, 14, 15, and 16 shall be repeated.
20. A very small drop of mounting medium shall be placed on each smear and a cover slip applied.
21. Slides shall be examined immediately to obtain optimal results. If a delay in reading is necessary, slides shall be placed in a darkened room and read within two hours.
22. Smears shall be studied microscopically, using an ultraviolet light source and a high power dry objective. The total magnification shall approximate 450X. A combination of BG 12 (primary filter) and OG 1 (secondary filter) has been found to be satisfactory for routine use.
23. Nonreactive smears shall be checked using illumination from a tungsten light source in order to verify the presence of treponemes.
24. The intensity of fluorescence of the treponemes shall be recorded according to the chart listed below, using the Reactive (2+) control slide as the reading standard:

	<u>Reading</u>	<u>Report</u>
4+	Very strongly fluorescent	Reactive (R)
3+	Strongly fluorescent	Reactive (R)
2+	Moderately fluorescent	Reactive (R)
1+	Weakly fluorescent	Reactive (R)
- to †	Vaguely visible	Nonreactive (N)

Readings of 1+ or more shall be reported as Reactive; less than 1+ shall be reported as Nonreactive.

Note: All borderline reactions (minimal 1+ to  $\pm$ ), where there is doubt regarding intensity of fluorescence, shall be verified by repeat testing before the result is reported.

\*Reactions read as less than the Reactive (2+) control but exhibiting definite fluorescence.

Control Pattern Illustration		<u>Reaction</u>
Reactive control:		
a. 1:5 saline dilution		R 4+
b. 1:5 sorbent dilution		R
Reactive (2+) control		R 2+
Nonspecific serum controls:		
a. 1:5 saline dilution		R (2+ - 4+)
b. 1:5 sorbent dilution		N
Nonspecific staining controls:		
a. Antigen, saline, and conjugate		N
b. Antigen, sorbent, and conjugate		N
Test runs in which the above control results are not obtained shall be considered unsatisfactory and shall not be reported.		

Note: Output of the ultraviolet light source shall be checked at the time a new bulb is put into use. A routine check each time the lamp is used will indicate any decrease in light intensity. A Weston Master No. 3 or No. 4 photoelectric exposure meter shall be used to determine the light intensity at, or immediately below, the microscope stage level, with the primary filter in place.



## VI. REFERENCES

- Deacon, W. E., Falcone, V. H., and Harris, A.: A fluorescent test for treponemal antibodies. *Proc. Soc. Exp. Biol. & Med.*, 96: 477-480, 1957.
- Deacon, W. E., Freeman, Elizabeth M., and Harris, A.: Fluorescent treponemal antibody test. A modification based on quantitation (FTA-200). *Proc. Soc. Exp. Biol. & Med.*, 103: 827-829, 1960.
- Deacon, W. E., and Hunter, Elizabeth F.: Treponemal antigens as related to identification and syphilis serology. *Proc. Soc. Exp. Biol. & Med.*, 110: 352-356, 1962.
- Hunter, Elizabeth F., Deacon, W. E., and Meyer, Patricia E.: An improved FTA test for syphilis, the absorption procedure (FTA-ABS). *Public Health Rep.*, 79: 410-412, 1964.

## MEDIA FOR CULTURING BACTERIA

## CREW AND ENVIRONMENT

PRIMARY CULTURING MEDIA1. Name: Blood Agar Plate

Purpose: Cultivate fastidious microorganisms

Comments: Use rabbit's blood, not sheep's blood, for primary culturing. Incubate at 35°C if using blood plate for secondary culturing, and if looking for hemolysis use sheep's blood.

Reference: Difco Manual (9th Ed.), page 80.

2. Name: Gall's Medium

Purpose: Anaerobic culturing

Comments: Thioglycollate medium is usually used routinely for the isolation of anaerobes. National Institutes of Health recommends thioglycollate broth without indicator.

Reference: Difco Manual (9th Ed.), page 195.

3. Name: Loeffler Blood Serum Agar

Purpose: Loeffler Blood Serum is employed in the cultural diagnosis of diphtheria. The growth of diphtheria bacilli is stimulated and other throat organisms are inhibited by this medium.

Comments: Needs special handling to sterilize medium. This is a difficult medium to prepare properly. CDC is now using Tinsdale (Difco Suppl. Lit., Sept., 1966, page 316). No whole egg in Difco's Loeffler's Medium (Difco Manual, 9th Ed., page 128).

Reference: BBL Catalog, page 65.

4. Name: Mac Conkey Agar

Purpose: Primary differential plating media for coliforms.

Comments: None

Reference: Difco Manual (9th Ed.), pages 131-132.

5. Name: Mannitol Salt Agar

Purpose: Isolation and identification of staphylococci.

Comments: Recommended incubation 36 hours. USPH uses TPEY medium or TPEY enrichment medium. Difco Suppl. Lit., Sept., 1966, pages 345-346.

Reference: Difco Manual (9th Ed.), page 150.

6. Name: Mitis-Salivarius Agar

Purpose: The detection of S. mitis, S. salivarius, and enterococci. Incubate exactly 24 hours at 35°C.

Comments: An alternate medium is KF Streptococcus broth as recommended by Difco Suppl. Lit., Sept., 1966, page 149.

Reference: Difco Manual (9th Ed.), pages 154-155.

7. Name: Phenylethyl Alcohol Agar

Purpose: PEA is a selective medium for the isolation of staphylococci and streptococci from specimens also containing gram negative organisms such as Proteus and Escherichia.

Comments: This medium is now called Phenyl-ethanol agar. The type of blood is not specified in Difco - rabbit's blood or primate isolation suggested. Selective for Staphylococci and Streptococci from specimens also containing gram negative organisms such as Proteus and E. coli. TPEY medium can also be used in conjunction with this medium.

Reference: Difco Suppl. Lit., Sept., 1966, pages 250, 345-346.

8. Name: Phytone Yeast Extract

Purpose: For the isolation of dermatophytes, especially T. verrucosum, from human and animal specimens.

Comments: Mycobiotic agar or brain heart medium with cyclohexamine and chloroamphenicol is recommended as a substitute by Difco. CDC suggests modified Sabouraud's Medium. Brooks Air Force personnel suggests Pagano Levin Agar for yeast culture.

Reference: BBL Catalog, Difco Suppl. Lit., Sept., 1966, page 232.

**SECONDARY CULTURING MEDIA**1. **Name:** Andrade's fermentation broth base

**Purpose:** Fermentation studies for cultural identification of pure cultures of microorganisms.

**Comments:** Replaces the old phenol red broth base and is more sensitive than these tests. Is recommended by the CDC and used in all public health laboratories. The formula is given in the appendix.

**Reference:** Ewing, W.H. 1962, Enterobacteriaceae, Biochemical methods for group differentiation. U.S. Dept. Health, Educ. & Welfare, P.H.S. C.D.C. Publication #734.

2. **Name:** Gall's Gelatin

**Purpose:** The use of gelatin in culture media for studies or gelatinolysis (elaboration of gelatinolytic enzymes) by bacteria.

**Comments:** None

**Reference:** None

3. **Name:** Litmus Milk

**Purpose:** Litmus milk is recommended for propagating and carrying stock cultures of the lactic acid bacteria and also for determining the action of bacteria upon milk.

**Comments:** None

**Reference:** Difco Manual (9th Ed.), page 192.

4. **Name:** Methyl Red-Voges Proskauer Broth (MRVP)

**Purpose:** Part of IMVIC schema for identifying Enterobacteriaceae.

**Comments:** None

**Reference:** Methyl Red Broth-P.R. Edwards and W.H. Ewing, Identification of Enterobacteriaceae, Burgess Pub. Co., Minneapolis, Minn., 1962, pages 248-249. Voges Proskauer Broth, *Ibid*, page 256.

5. Name: Nitrate Broth

Purpose: Part of IMVIC schema for identifying Enterobacteriaceae.

Comments: If the organism is a rapid grower, may have to read the test earlier than 48 hours.

Reference: Difco Manual (9th Ed.), pages 184-185.

6. Name : Phenylalanine

Purpose: Part of IMVIC schema for identifying Enterobacteriaceae.

Comments: Particularly used for identifying the Proteus group. Phenylalanine-Malonate Broth. Difco Suppl. Lit., Sept., 1966, page 250. Also recommended to be used concurrently as more complete differentiation can be obtained.

Reference: Difco Suppl. Lit., Sept., 1966, page 249.

7. Name: Potassium Cyanide Broth Base

Purpose: KCN broth base is recommended for the differentiation of Enterobacteriaceae, particularly to separate the Salmonellae from the Bethesda-Ballerup group and to distinguish the Klebsiella from Escherichia coli. Moeller showed that media containing potassium cyanide permitted differential growth of Enterobacteriaceae. E. coli, Salmonella and Shigella were inhibited in the medium while members of the Klebsiella, Bethesda-Ballerup and Proteus groups grew unrestrictedly. E. freundii also grew in the medium.

Comments: SPECIAL PRECAUTION IN MAKING MEDIUM: Cool sterile (autoclaved) base below 20°C. Dissolve 0.5 g KCN in 100 ml sterile cold (below 20°C) distilled H<sub>2</sub>O. Add 15 ml of this/1000 ml base. Extreme caution should be taken when handling potassium cyanide. Use sterile paraffined stoppers or screw capped tubes. Quickly stopper tubes after inoculation. Ewing, Davis and Edwards recommend dicarboxylase differential media (Difco Suppl. Lit., Sept., 1966, pages 75-76).

Reference: Difco Suppl. Lit., Sept., 1966, page 148.

**CARBOHYDRATE FERMENTATION TESTS****Andrade's Fermentation Broth Base**

(glucose, lactose, sucrose, mannitol, dulcitol, salicin, adonitol, inositol).

Peptone . . . . .	10 gm
Meat extract . . . . .	3 gm
Sodium chloride . . . . .	5 gm
Andrade's indicator . . . . .	10 ml
Distilled water. . . . .	1000 ml

Adjust reaction to pH 7.1 to 7.2. Tube with inverted insert tubes and sterilize at 121°C for 15 minutes.

Glucose, lactose, sucrose, and mannitol are employed in a final concentration of 1 percent by the author. Other carbohydrates such as dulcitol, salicin, etc., are used in a final concentration of 0.5 percent. Glucose, mannitol, dulcitol, salicin, adonitol, and inositol may be added to the basal medium prior to sterilization. Disaccharides such as lactose and sucrose (10 percent solution in distilled water) should be sterilized by filtration or at 121°C for 10 minutes and added to previously sterilized basal medium.

**Inoculation:**

Inoculate lightly from a young (18-20 hours incubation) agar slant culture.

**Incubation:**

37°C. Examine daily for 4 or 5 days.

Note acid production and the volume of gas produced by aerogenic cultures. Negative tests should be observed at regular intervals for a total of 30 days.

**Andrade's Indicator**

Distilled water . . . . .	100 ml
Acid fuchsin . . . . .	0.5 gm
Sodium hydroxide (1N) . . . . .	16 ml

The fuchsin is dissolved in the distilled water and the sodium hydroxide is added. If, after several hours, the fuchsin is not sufficiently decolorized, add an additional 1 or 2 ml of alkali. The dye content of different samples of acid fuchsin varies quite widely and the amount of alkali which should be used with any particular sample usually is specified on the label. The reagent improves somewhat on aging and should be prepared in sufficiently large amounts to last for several years. The indicator is used in amount of 10 ml per liter of medium.

**Reference:**

Ewing, W.H., 1962, Enterobacteriaceae. Biochemical Methods for Group Differentiation, U.S. Dept. H.E.W. PHS, CDC, Publication #734.

### ADDITIONAL TESTS

1. Name: Bile Solubility Test

Purpose: To identify pneumococci.

Comments: Uses a few drops of 10% solution of sodium desoxycholate or sodium taurocholate added to culture in broth.

Reference: W.R. Bailey and E.G. Scott, Diagnostic Microbiology, 2nd Edition, C.V. Mosby Co., St. Louis, Missouri, 1966, page 119.

2. Name: Catalase Test

Purpose: To determine the presence or absence of the enzyme catalase to differentiate several groups of organisms.

Comments: Use 1 ml of 3% solution of Hydrogen peroxide over the growth or to a culture.

Reference: W.R. Bailey and E.G. Scott, Diagnostic Microbiology, 2nd Edition, C.V. Mosby Co., St. Louis, Missouri, 1966, page 327.

3. Name: Cytochrome Oxidase Test

Purpose: This rapid test allows for a convenient differentiation between Pseudomonas and other gram-negative, lactose-negative colonies.

Comments: Just called "oxidase test." Difco now has discs for more rapid screening (Difco. Suppl. Lit., Sept., 1966, page 87).

Reference: P.R. Edwards and W.H. Ewing, Identification of Enterobacteriaceae, Burgess Pub. Co., Minneapolis, Minn., 1962, pages 251-252.

4. Name: Oxidase Test

Purpose: To test for the presence of the oxidase enzyme produced by Neisseria.

Comments: Difco has discs for more rapid screening methods. Difco Suppl. Lit., Sept., 1966, page 87.

Reference: W.R. Bailey and E.G. Scott, Diagnostic Microbiology, 2nd Edition, C.V. Mosby Co., St. Louis, Missouri, 1966, pages 329-330.



## LUNAR SAMPLE CULTURING

BIPHASIC CULTURING

This simple technique shall be used in addition to routine liquid and solid culturing as it has been proven to provide optimum growth conditions. A 9-10-fold increase in the total number of organisms has been reported, compared to conventional liquid cultures using the same medium.

The system consists of a solid complete medium base with a distilled water overlay. The nutrients slowly diffuse into the liquid menstrum. The toxic end-products from the liquid are in turn absorbed by the agar. 0.1 - 1% charcoal or soluble starch can also be added to the agar base if so desired. It has the advantages of providing an initially diluted medium, a reservoir of slowly released nutrients, and a capability of absorbing toxic products from the medium. The optimal ratios for a 250 ml Erlenmeyer flask are as follows:

50 ml of solid medium

12.5 ml distilled water overlay which is allowed to equilibrate overnight.

Preparation is very simple, as the medium of choice (heart infusion broth, trypticase-soy broth, etc.) can be both autoclaved and solidified in the same flasks used for the experiment. These can be prepared in advance and stored, since the water layer is not added until needed.

Reference:

E.A. Tyrrell, R.E. MacDonald, P. Gerhardt, 1958, J. Bacteriol., 75, 1.

PROTOCOL FOR MEDIA CONTAINING C<sup>14</sup>- Labeled SUBSTRATES

"Many terrestrial microorganisms metabolize organic substrates to yield CO<sub>2</sub>. Production of C<sup>14</sup>O<sub>2</sub> from labeled substrates would provide an indication of viable organisms in lunar sample, and indicate a similarity of metabolic pathways." Horowitz, H.H., 1966. Science 151: 789-792.

1. Media

a. Broth base

Brain-heart infusion or inorganic medium or even soil extract medium shall be considered.

b. Radioactive compounds

DL-C<sup>14</sup>-labeled substrates shall be used. Carbonate, glucose, lactate, glutamate or acetate shall be used. Either uniquely or uniformly labeled compounds can be used.

c. Preparation

- (1) Brain-heart infusion broth shall be dispensed in 10 ml amounts in 18 x 150 mm test tubes or 50 ml Erlenmeyer flasks and autoclaved. The glassware shall be equipped with 2 side arms and screw caps.
- (2) All three radioactive substrates shall be added to 10 ml of brain-heart infusion broth, and sterilized by Millipore filtration. One ml of this solution shall be added to each tube or flask of brain-heart infusion broth. The final concentration in the medium shall be at least 6,000-10,000 counts/minute/ml which should be sufficient to provide useful data if C<sup>14</sup>O<sub>2</sub> is evolved.

## 2. Inoculation

This medium shall be inoculated with either a direct sample or a suspension of the lunar material.

## 3. Incubation

### a. Aeration

(1) One sample shall be incubated aerobically with air access through one side arm. A bacteriological filter (cotton, glass wool) shall be used.

(2) Another sample shall be incubated anaerobically.

### b. Agitation

Shaking incubators shall be used if possible.

### c. Temperatures

25°C and 35°C shall be used.

### d. Time

Cultures shall be incubated for 7 days.

## 4. Determination of radioactivity in effluent gases

A very slow stream of sterile air shall be used to sweep the aerobic cultures, and sterile nitrogen shall be used with the anaerobic ones. The gaseous effluent shall be collected during the incubation period through the second side arm and bubbled through measured aliquots of 0.25 M Ba(OH)<sub>2</sub>. The resultant precipitate shall be placed in planchets, or dried and counted in a recording Geiger-Mueller counter.

## 5. Controls

Controls shall be run with the uninoculated media. Radioactivity of the lunar sample in BHI broth with non-radioactive substrates shall also

be monitored. The possibility exists that there is  $C^{14}$  in the lunar sample due to an induced transmutation of nitrogen by the cosmic ray neutron component.

6. Precautions

The long half-life of  $C^{14}$  requires that it be handled as carefully as radium or other long-lived radioactive bodies. Safety trays shall be used and the preparation areas carefully monitored. Appendix 3 in Radioactive Tracers in Biology, 1951, M. Kamen, Academic Press, Inc. pp. 378-381 presents some detailed typical working rules to be followed in a radio-chemistry laboratory.

VOLCANI'S MEDIAStandard mineral base:

## Solution A (0.2 M)

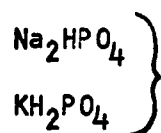

Mixed in proportions to give desired pH.

## Solution B (g/l)



## Solution C (mg/100 ml)



These stock solutions were mixed in the following proportions and diluted to 1 liter with distilled water.

Additions to this base:

- 0.2% Na-acetate                      pH 7.0                      (aerobic)
- 1 + 0.02% NH<sub>4</sub>Cl                      (aerobic)
- 0.4% amy1 alcohol                      pH 6.5                      (aerobic)  
0.02% NH<sub>4</sub>Cl  
2% agar
- 5% starch                                      (aerobic)  
0.01% yeast extract (Difco)  
0.002% NH<sub>4</sub>Cl  
2% agar

5. 0.5% yeast extract      pH 6.8-7.0      (aerobic)  
0.05%  $\text{MgSO}_4 \cdot 7\text{H}_2\text{O}$   
0.1%  $\text{K}_2\text{HPO}_4$
6. 5 + 2% agar      (aerobic)
7. 5 + 0.1% lactose      (aerobic shaken)
8. 0.5% yeast extract  
0.5% proteose peptone (Difco)  
2% glucose  
2%  $\text{CaCO}_3$       (anaerobic in stoppered  
reagent bottles)

#### REFERENCE

Volcani, 1966. "A Study of the Optical Rotation of Lipids Extracted from Soils, Sediments and the Orgueil Carbonaceous Meteorite" by Bartholomew Nagy. Proc. Nat. Acad. Science, August, 1966.

SPECIAL REQUIREMENTS FOR RELATIVE HUMIDITY

RH:				
0	=	10,000	Atmospheres	suction
10	=	7,500	"	"
50	=	1,000	"	"
93	=	100	"	"
98	=	31	"	"
99	=	15	"	"
100	=	0.5	"	"

## CULTURING BACTERIA FOR LUNAR CHALLENGE

Potato Extract Medium for Sporulation of *Bacillus*

200 g of diced potatoes shall be heated at 100°C for 5 minutes in 1 liter distilled H<sub>2</sub>O. After filtering through 2 sheets of Whatman #1 filter paper, the volume shall be brought up to 1 liter with distilled H<sub>2</sub>O. 20 g N-Z case peptone and 2 g yeast extract shall be added. The pH shall be adjusted to 7.2, and the total volume shall be brought up to 2 liters. It shall be dispensed and autoclaved at 121°C for 20 minutes.



Minimal Medium for *B. subtilis*

$(\text{NH}_4)_2\text{SO}_4$	0.20 grams
$\text{K}_2\text{HPO}_4$	1.40 grams
$\text{KH}_2\text{PO}_4$	0.60 grams
Sodium citrate $\cdot 2\text{H}_2\text{O}$	0.10 grams
$\text{MgSO}_4 \cdot 7\text{H}_2\text{O}$	0.02 grams
Glucose	0.50 grams
Distilled $\text{H}_2\text{O}$	100 ml

Anagnostopoulos, C. and J. Spizizen, 1961, *J. Bacteriol.*, 81, page 741.

"C" Medium(Minimal Medium for *E. coli*)

	gm/liter
$\text{NH}_4\text{Cl}$	2.0
$\text{Na}_2\text{HPO}_4 \cdot 7\text{H}_2\text{O}$	12.1
$\text{KH}_2\text{PO}_4$	3.0
$\text{NaCl}$	3.0
$\text{KCl}$	2.0
$\text{MgCl}_2 \cdot 6\text{H}_2\text{O}$	0.02
$\text{Na}_2\text{SO}_4$	0.026
Glucose	7.0
pH 7.3	

Roberts, R. B., P. H. Abelson, D. B. Cowie, E. T. Bolton, R. J. Britten,  
1957. Carnegie Inst. of Washington, D.C. Pub. 607, 5.

Medium for growing bacteria (*Bacillus subtilis*; *E. coli*)

<u>Maximum type</u>	<u>mg/liter</u>
$(\text{NH}_4)_2\text{HPO}_4$	8,000
$\text{FeCl}_3 \cdot 6\text{H}_2\text{O}$	33
$\text{MgSO}_4 \cdot 7\text{H}_2\text{O}$	614
$\text{MnSO}_4$	15
KCL	400
NaCl	300
$\text{Na}_2\text{SO}_4$	4,000
$\text{ZnCl}_2$	10
Citric acid	2,000
Sucrose	100,000
Asparagine	2,000
Glutamic acid	2,000
Adenine sulfate	40
Guanine HCl	40
Uracil	40
Xanthine	40
p-aminobenzoic acid	0.02
Biotin	0.02
Choline Cl	10
Folacin	0.02
L-inositol	10
Niacin	2
DL-Ca pantothenate	4
Pyridoxine HCl	2
Pyridoxamine HCl	2
Riboflavin	4
Thiamine HCl	4
Glucose	5,000

Feeney, R. E., J. A. Garibaldi, and E. M. Humphreys. 1948. Arch. Biochem. 17:435.

## MEDIA FOR CULTURING TREPONEMES

Cannefax Treponeme Medium

	<u>grams/liter</u>
Spirolate	14.5
BHI	18.5
Thioglycollate	0.5
Asparagine	0.25
Tryptone	0.25
Water	1,000 ml

C.D.C.

Personal communication to Dr. W. Dacres from  
Dr. George R. Cannefax.

Stuart's Leptospira Medium

See Stuart, R.D., 1946. The preparation and use of a simple culture medium for leptospirae. J. Pathol. and Bacteriol. 58, 343-349.

Galton, M.M., R.W. Menges, E.B. Shotts, Jr., A.J. Nahmias, and C.W. Heath, Jr., 1962. Leptospirosis epidemiology, clinical manifestations in man and animals in laboratory diagnosis. USPHS Publ. 951. CDC.

## MEDIA FOR CULTURING MYCOPLASMA

Hayflick's media for Mycoplasma (Hayflick, 1965)

PPL0 Agar consists of:

70 ml PPL0 agar

20 ml horse serum

10 ml of a 25% aqueous freshly prepared yeast extract.

Hayflick, L. Tex. Rep. Biol. Med., Suppl. 1: 23, 285, 1965.

## Ford's modification (Ford, 1967)

10 ml horse serum and an additional 10 ml of PPL0 agar or broth containing urea to give a final concentration of 1% in the completed medium.

Do not use thallium as it seems to inhibit the T strains.

The routine use of this modification is suggested instead of PPL0 agar, per se, since it enhances the growth of "T" and possibly other strains as well.

## STAINING PROCEDURES

GRAM STAIN

(1) Components - Gram stain (Hucker's Modification).

(2) Crystal violet solution

Solution A:	Crystal violet	4.0 gm.
	(85% dye content)	
	Ethyl alcohol	20.0 ml.
	(95%)	

Solution B:	Ammonium oxalate	0.8 gm.
	Distilled water	80.0 ml.

Dilute solution A about 1:10 with distilled water and mix with 4 parts of solution B.

(3) Lugol's iodine:

Iodine	1.0 gm.
Potassium iodide	2.0 gm.
Distilled water	300.0 ml.

Allow to stand 24 hours for the iodine to dissolve.

(4) Decolorizer  
95% alcohol (ethyl)

(5) Counterstain

Safranin Stock		
Solution:	Safranin	2.5 gm.
	Alcohol	100.0 ml.
	(95%)	

To 10.0 ml. of stock solution, add 100.0 ml. distilled water.

(6) Staining procedure - Gram stain

Prepare smear, dry, flame fix.

Stain for 1 minute in crystal violet solution.

Rinse with water.

Fix for 1 minute with Gram's iodine solution.

Rinse with water.

Flood with 95% alcohol until all but thickest parts of smear have ceased to give off dye - about 30 seconds.

Rinse with water.

Counterstain about 30 seconds with safranin.

Wash in water; dry.

ACID FAST STAIN (ZIEHL NEELSEN)

Chemicals for acid-fast stain (Ziehl-Neelsen)

## 1) Carbol-fuchsin:

Basic fuchsin (certified, 3% by weight in  
95% ethyl alcohol)..... 10.0 ml  
Phenol (5% in distilled water)..... 90.0 ml

Mix. Let stand several days before use.

## 2) Acid alcohol:

Ethyl alcohol (95%)..... 97.0 ml  
Hydrochloric acid (conc.)..... 3.0 ml

## 3) Methylene blue (Loeffler's):

Solution A:

Methylene blue (90% dye content)..... 0.3 gm  
Ethyl alcohol (95%)..... 30.0 ml

Solution B:

Dilute potassium hydroxide (0.01% by  
weight).....100.0 ml

Mix Solutions A and B.

## 4) Staining Procedure

- a. Cover smear with carbol-fuchsin stain
- b. Steam gently for 3 to 5 min.
- c. Wash with tap water
- d. Add acid-alcohol until smear is colorless
- e. Wash with tap water
- f. Counterstain with methylene blue 5 to 20 sec.
- g. Wash, dry, and examine under oil immersion

SPORE STAIN

Chemicals for spore stain (Wirtz)

## 1) Malachite green:

Malachite green (oxalate)..... 8.0 gm  
Distilled water.....100.0 ml

## 2) Safranin: same as used for Gram's stain.

## 3) Staining Procedure

- a. Flood slide with malachite green stain and steam gently for 10 min by heating with Bunsen burner. Do not allow stain to boil or dry up
- b. Stain with safranin
- c. Wash, blot dry, and examine under oil immersion

To preserve smears, cover with cover glass

## MEDIA FOR CULTURING ALGAE

## 1. Modified Bristol's sodium nitrate solution

$\text{KH}_2\text{PO}_4$	0.5 gm
$\text{NaNO}_3$	0.5 gm
$\text{MgSO}_4 \cdot 7\text{H}_2\text{O}$	0.15 gm
$\text{CaCl}_2 \cdot 6\text{H}_2\text{O}$	0.05 gm
$\text{NaCl}$	0.05 gm
$\text{FeCl}_3 \cdot 6\text{H}_2\text{O}$	0.01 gm
tap water	1000 ml

for isolating soil algae

Allen, O.N. 1949. Experiments in soil bacteriology. Burgess Publishing Co., Minneapolis, Minnesota

## 2. Algae growth medium

Chlorella medium

$\text{H}_3\text{BO}_3$	0.5 mg
$\text{CaCl}_2$	0.5 mg
$\text{Co}(\text{NO}_3)_2 \cdot 6\text{H}_2\text{O}$	0.01 mg
$\text{CuSO}_4 \cdot 5\text{H}_2\text{O}$	0.04 mg
$\text{FeSO}_4 \cdot 7\text{H}_2\text{O}$	0.2 mg
$\text{MgSO}_4 \cdot 7\text{H}_2\text{O}$	500 mg
$\text{MnCl}_2 \cdot 4\text{H}_2\text{O}$	0.5 mg
$\text{Na}_2\text{MoO}_4$	0.02 mg
$\text{KH}_2\text{PO}_4$	1.31 gms
$\text{NH}_4\text{VO}_3$	0.01 mg
$\text{ZnSO}_4 \cdot 7\text{H}_2\text{O}$	0.5 mg
urea	440 mg
water	make up to 1000 ml

pH 6.0

J. Brunel, ed. The Culturing of Algae. 1950. C. F. Kettering Foundation, Dayton.

Additional information on culturing of algae in article by Pringsheim, E. G. in J. Brunel's book.

3. Malt extract agar

BBL supplemented with 1% Bactoagar (Difco)

H<sub>2</sub>SO<sub>4</sub> to pH 3.5

Isolation of thermophilic algae

4. Liquid inorganic culture media

pH 2

Incubate at 45°C

Aeration and illumination

Thermophilic algae

M. B. Allen, Arch. Mikrobiol. 32: 270, 1959.

5. Liquid organic media with galactose and malt extract

Incubate at 60°C

Agitation and illumination

Thermophilic algae

Ascione et al., Science, August 12, 1966.



## MEDIA FOR CULTURING FUNGI

A. General Types

## 1. Potato Dextrose Agar

Distilled water	make up to 1000 ml
Potatoes, infusion from	200 g
Dextrose	20 g
Agar	15 g

Also available from Difco in dehydrated form

Difco Manual, page 65

## 2. Corn-meal agar

Corn meal, infusion from	20 g
Dextrose	20 g
Agar	17 g
Water	make up to 1000 ml

Also available from Difco in dehydrated form

Difco Manual, page 247

Johnson, et al. Methods for studying soil microflora-plant disease relationships. Burgess Publishing Co., 1959

## 3. Malt extract agar

Malt extract	20 gm
Dextrose	20 gm
Peptone	1 gm
Agar	25 gm
Water	make up to 1000 ml

Also available from Difco in dehydrated form

Difco Manual, page 244

Raper, K. B. and C. Thom. A manual of the Penicillia. Williams-Wilkins Co., Baltimore, Md., 1949

B. Synthetic media, general types

## 1. Czapek-dox agar-

Agar	15 gm
NaNO <sub>3</sub>	3 gm
K <sub>2</sub> HPO <sub>4</sub>	1 gm
MgSO <sub>4</sub> · 7H <sub>2</sub> O	0.5 gm

KCl	0.5 gm
FeSO <sub>4</sub> · 7H <sub>2</sub> O	0.01 gm
Sucrose	30.0 gm
Water	make up to 1000 ml

Note: Some prefer to add 1 gram of yeast extract to the above media.

Difco Manual, page 2/45

Conn, H. J. The use of various culture media for characterizing actinomycetes, in Johnson, et al. Methods for studying soil microflora: plant disease relationships. Burgess Pub. Co., 1959.

## 2. Basidiomycete media

H <sub>3</sub> BO <sub>3</sub>	0.57 mg
CuSO <sub>4</sub> · 5H <sub>2</sub> O	0.04 mg
FeSO <sub>4</sub> · 7H <sub>2</sub> O	0.15 mg
MgSO <sub>4</sub> · 7H <sub>2</sub> O	500 mg
MnCl <sub>2</sub> · 4H <sub>2</sub> O	0.04 mg
KH <sub>2</sub> PO <sub>4</sub>	1.5 gms
ZnSO <sub>4</sub> · 7H <sub>2</sub> O	0.31 mg
Ammonium para molybdate	0.02 mg
Glucose	10 gms
L-glutamic acid	1.2 gms
Thiamine HCl	1 mg
pH 5.0 - 5.5	

Used for culturing basidiomycetes

Jennison, M.W. et al. 1955. Mycologia 47: 275

## C. Specialized media

### 1. Soil extract agar

Agar	15 gms
K <sub>2</sub> HPO <sub>4</sub>	0.2 gms
Soil extract	1000 ml

Soil extract is prepared by autoclaving 1000 gms of soil

with 1000 ml of tap water for 20 minutes at 15 lbs pressure.

Material is filtered and the pH adjusted to 6.8.

Lochhead, A.G. Qualitative studies on soil microorganisms.

Canadian J. Research 18: 42, 1940.

## 2. Natural media

Agar 15 gms  
Natural material previously sterilized by exposure to propylene oxide  
and water to make up to 1000 ml.

Commonly used with pea straw, plant parts, etc.

Very good for stimulating growth and sporulation of many fungi.

Snyder, W.C. and Hansen, H.N. Advantages of natural media and  
environments in the culture of fungi. Phytopath. 37: 420, 1947.

## 3. Liquid media

Soil Extract Agar and Material Media

Can be used as liquid media by leaving out the agar.

## 4. Jensen's agar medium

Agar	15 gms
Dextrose	2 gms
Casein (dissolved in 10 ml of 0.1 N NaOH)	0.2 gm
K <sub>2</sub> HPO <sub>4</sub>	0.5 gm
MgSO <sub>4</sub> · 7H <sub>2</sub> O	0.2 gm
FeCl <sub>3</sub> · 6H <sub>2</sub> O	0.05 gm
Water	make up to 1000 ml
	adjust pH to 6.5

For isolating actinomycetes from soil

Jensen, H.L., Actinomycetes in Danish soils. Soil Sci. 30: 59, 1930.

## 5. Sabhi-blood Media

Sabouraud's dextrose agar  
Brain heart infusion agar enriched with blood  
Chloramphenicol to inhibit bacterial growth

Detection of pathogenic fungus in cases of histoplasmosis-blastomycosis

J.W. Gorman of Mississippi State Sanatorium

6. Sabouraud's Media

Incubate at 35 and 56°C in light and dark.

7. Neurospora Media

Vogel, H.J., Microb. Gen. Bull. 13: 42, 1956.

## 50 X Citrate Solution

	1 liter	10 liters	15 liters
Na <sub>3</sub> Citrate·2H <sub>2</sub> O (Na <sub>3</sub> C <sub>6</sub> H <sub>5</sub> O <sub>7</sub> ·2H <sub>2</sub> O)	150 gm	1500 gm	2250 gm
KH <sub>2</sub> PO <sub>4</sub> - anhydrous (monobasic)	250 gm	2500 gm	3750 gm
NH <sub>4</sub> NO <sub>3</sub> - anhydrous	100 gm	1000 gm	1500 gm
MgSO <sub>4</sub> ·7H <sub>2</sub> O	10 gm	100 gm	150 gm
CaCl <sub>2</sub> ·2H <sub>2</sub> O	5 gm	50 gm	75 gm
Trace element solution (see below)	5 ml	50 ml	75 ml
Biotin solution (see below)	2.5 ml	25 ml	37.5 ml
Chloroform as a preservative Store at room temperature	2 ml	20 ml	30 ml

pH 5.8

Note: Each chemical has to be added separately and in order.  
Each should be in solution before the other is added.  
Start with 3/4ths the total liquid volume and dilute to final volume  
after all chemicals are in solution.

Trace Element Solution

Citric acid·1H <sub>2</sub> O (HOCCOH(CH <sub>2</sub> COOH) <sub>2</sub> ·H <sub>2</sub> O)	100.00 ml
	5.00 gm
ZnSO <sub>4</sub> ·H <sub>2</sub> O	5.00 gm
Fe(NH <sub>4</sub> ) <sub>2</sub> (SO <sub>4</sub> ) <sub>2</sub> ·6H <sub>2</sub> O	1.00 gm
CuSO <sub>4</sub> ·5H <sub>2</sub> O	0.25 gm
MnSO <sub>4</sub> ·1H <sub>2</sub> O	0.05 gm
H <sub>3</sub> BO <sub>3</sub> - anhydrous	0.05 gm
Na <sub>2</sub> MoO <sub>4</sub> ·2H <sub>2</sub> O	0.05 gm

Total volume: 100 ml (Start with 75 ml H<sub>2</sub>O, adjust volume to 100 ml)

Add 1 ml chloroform. Store at room temperature.

Biotin Solution

5.0 mg/50 ml H<sub>2</sub>O. Store in freezer.  
Warm to get biotin into solution.

Liquid Media (for Neurospora)

		500 ml	1000 ml
50 X Citrate	2 ml %	10 ml	20 ml
Sucrose	1 gm %	5 gm	10 gm
Dist. H <sub>2</sub> O	98 ml %	490 ml	980 ml

Supplement as required for specific mutants in 10 mg % amounts.

Minimal Agar (Neurospora)

		500 ml	1000 ml
50 X Citrate	2 ml %	10 ml	20 ml
Dist. H <sub>2</sub> O	98 ml %	490 ml	980 ml
Sucrose	0.5 gm %	2.5 ml	5 gm
Sorbose	0.75 gm %	3.75 gm	7.5 gm
Bacto agar	1.5 gm %	7.5 gm	15 gm

## STAINING PROCEDURES FOR FUNGI

KINYOUN ACID FAST STAIN

1. Phenol crystals (Melt in water and then weigh).	20.0 gm. <u>Kinyoun carbol fuchsin</u>
2. Lactic acid	20.0 gm.
3. Glycerin	40.0 gm.
4. Cotton blue (Poirrier's blue)	0.05 gm.
5. Distilled water	20.0 ml.
6. Basic fuchsin	4.0 gm.
7. Phenol crystals	8.0 gm.
8. Alcohol crystals (95%)	20.0 ml.
9. Distilled water	100.0 ml.

LACTO-PHENOL COTTON BLUE STAIN

Used for preparing mounts for the study of fungus cultures.

1. Phenol crystals (Melt in water bath and then weigh)	20.0 gm.
2. Lactic acid	20.0 gm.
3. Glycerin	40.0 gm.
4. Cotton Blue (Poirrier's blue)	0.05 gm.
5. Distilled water	20.0 ml.

### SLIDE CULTURE TECHNIQUE

- (1) In the study of fungi, it is often necessary to observe the undisturbed relationship between reproductive structures and mycelium. This may be accomplished by growing fungi on glass slides in a moist chamber.
- (2) Place a slide on a bent glass rod in the bottom of a petri dish. Cover and sterilize.
- (3) Prepare Sabouraud dextrose agar plates with 15 ml of agar per plate. Permit to solidify. Use to obtain agar blocks 1 cm square and 2-3 mm deep.
- (4) Place block of agar, using sterile techniques, on slide in petri dish.
- (5) Inoculate centers of four sides of agar block with lunar sample to study fungus.
- (6) Cover inoculated block with sterile coverslip.
- (7) Using sterile techniques, add 8 ml of sterile water to bottom of petri dish.
- (8) Incubate at 25 degrees C until sporulation occurs.
- (9) When spores appear, carefully lift off coverslip and lay aside with fungus growth upward.
- (10) Lift agar square from slide and discard.
- (11) Place drop of lacto-phenol cotton blue on this slide and cover with a clean coverslip. Obtain clean slide, place drop of lacto-phenol cotton blue near one end, and cover with original coverslip with mycelial surface down.
- (12) Blot away excess mounting fluid from coverslips of the two preparations. When dry, seal edges with asphalt tar varnish.



DATA ON HIGHER PLANT MATERIALS

Subject	Substratum where it can be grown	Temperature °C	Number of days for root development	Photoperiod
<u>Pinus palustris</u> (Long leaf pine)	Peat moss-soil mixture or agar media in test tubes	23-25	15-20	12 hour cycle
<u>Allium cepa</u> (Onion bulbs)	Beaker of water	20	6-10	12 hour cycle
<u>Zea mays</u> (Corn)	Between blotters, petri plate, polyethylene beads	25	5-5	12 hour cycle
<u>Triticum vulgare</u> (Wheat)	Between blotters, petri plate, polyethylene beads	25-26	4-5	12 hour cycle
<u>Oryza sativa</u> (Rice)	Blotters, petri plate, etc.	23-25	4-5	12 hour cycle
<u>Avena sativa</u> (Oats) var. victory	Blotters, petri plate, etc.	15	5-10	12 hour cycle
<u>Spinacea oleracea</u> (Spinach)	Blotters, petri plate, etc.	23-25	4-5	12 hour cycle
<u>Phaseolus vulgaris</u> (Bean)	Blotters, petri plate, etc.	20-30	5-8	12 hour cycle
<u>Vicia faba</u> (Broad bean)	Cellulose paper pads or polyethylene beads	25	4-14	12 hour cycle
<u>Pisum sativum</u> (Alaska pea)	Blotters, petri plate, etc.	20	4-6	12 hour cycle
<u>Daucus carota</u> (Carrot)	Agar media	23-25	10-15	12 hour cycle
<u>Lycopersicon esculentum</u> (Tomato)	Blotters, petri plate, etc.	20-30	5-10	12 hour cycle
<u>Nicotiana tabacum</u> (Tobacco)	Blotters, petri plate, etc.	20-30	7-14	12 hour cycle
<u>Antirrhinum maius</u> (Snapdragon)	Agar media or blotters	23-25	4-5	12 hour cycle
<u>Lactuca sativa</u> (Lettuce)	Blotters, petri plate, etc.	23-25	4-5	12 hour cycle
<u>Xanthium pennsylvanicum</u> (Cocklebur)	Peat moss-soil mixture	23-25	4-5	12 hour cycle

REFERENCE: Growth including Reproduction and Morphological Development. 1962. Compiled and Edited by P.L. Altman and D.S. Dittmer. Federation of Amer. Soc. for Exptl. Biol., Washington, D.C.

## GENERAL PROCEDURES FOR SURFACE-STERILIZED SEEDS AND GNOTOBIOTIC PLANTS

1. All procedures shall be carried out under total aseptic conditions. All glassware and other materials shall be autoclaved. Instruments shall be sterilized by dipping them in 70% alcohol and flamed before use.
2. Seeds shall be soaked in a wetting agent (95% alcohol or 0.1% tween) for 5-10 minutes.
3. The soaked seeds shall be surface-sterilized in 5-10% calcium hypochlorite or 15% commercial chlorox for 5-20 minutes depending on the nature of the seed.
4. After sterilization, the seeds shall be washed in sterile distilled water 4-5 times.
5. If the seed coats are hard and wrinkled, seeds shall be surface-sterilized and soaked in sterile water for 4-12 hours. The sterilization procedures shall then be repeated.
6. The concentration of the sterilization solution and the sterilization time will vary with different plant materials and are very critical.
7. Small seeds such as tobacco shall be sterilized in a beaker, then filtered and washed in a filtering apparatus. The seeds shall be transferred from the filter paper to a sterile petri plate.
8. Surface-sterilized seeds shall be transferred to petri plates containing sterile moistened filter paper or media for germination studies.
9. Germ-free plants shall be obtained by growing the surface-sterilized seeds in a gnotobiotic environment using aseptic procedures.

## MEDIA AND SOLUTIONS

Oatmeal agar medium for Physarum

Rolled oats	30 gm
Agar	15 gm
Distilled water	1 liter

Pollen germinationStock solution (10 x concentration)

$H_3BO_3$	1.0 gm
$Ca(NO_3)_2 \cdot 4 H_2O$	3.0
$MgSO_4 \cdot 7 H_2O$	2.0
$KNO_3$	1.0
Water to make	1 liter

Use 1 part stock to 9 parts of distilled water, add 9.5% sucrose and 10 g/l agar.

Translocation solution

Hoagland's solution

Glucose- $C^{14}$

A few drops of methylene blue (dye)

Hoagland's Solution

	Ml
1 M $\text{Ca}(\text{NO}_3)_2$	10
1 M $\text{KNO}_3$	10
1 M $\text{MgSO}_4$	4
1 M $\text{KH}_2\text{PO}_4$	2
FeEDTA*	2
Micronutrient stock solution	2
Distilled water	2000

Micronutrient stock solution	g/l
Boric acid	2.86
$\text{MnCl}_2 \cdot 4 \text{H}_2\text{O}$	1.81
$\text{ZnCl}_2$	0.11
$\text{CuCl}_2 \cdot 2 \text{H}_2\text{O}$	0.05
$\text{Na}_2\text{MoO}_4 \cdot 2 \text{H}_2\text{O}$	0.025

\* This is sold as "sequestrene NaFe" by Geigy Agricultural Chemicals,  
89 Barclay St., N. Y. 8, N.Y.

Machlis, L. and J.G. Torrey. 1956. Plants in action, A Laboratory Manual  
of Plant Physiology. W.H. Freeman and Co., San Francisco, California.

Standard media for higher plants

$\text{Ca}(\text{NO}_3)_2$	0.003 M
$\text{KNO}_3$	0.002 M
$\text{MgSO}_4$	0.002 M
$\text{KH}_2\text{PO}_4$	0.002 M

iron ethylenediamine tetraacetic acid solution is added to give 5 ppm in one liter

minor elements      gms per liter

$\text{H}_3\text{BO}_3$	2.5
$\text{MnCl}_2 \cdot \text{H}_2\text{O}$	1.5
$\text{ZnCl}_2$	0.10
$\text{CuCl}_2 \cdot 2\text{H}_2\text{O}$	0.05
$\text{MoO}_3$	0.05

Meyer, Anderson, Bohning. 1960. Introduction to Plant Physiology  
D. Van Nostrand, Co., New York.

## COMPOSITION OF TISSUE CULTURE MEDIA

Stock solutions are generally made using distilled deionized water. Absolute care should be taken to see that the salts dissolve thoroughly. Stock solutions can be maintained for 1-2 months under refrigeration.

1. Knudson's Solution (X 4, dilute 1:3)

Major elements:

		Final concentration
$\text{Ca}(\text{NO}_3)_2 \cdot 4 \text{H}_2\text{O}$	8.0 gm	500 mg/liter
$(\text{NH}_4)_2 \text{SO}_4$	4.0	250
$\text{MgSO}_4 \cdot 7 \text{H}_2\text{O}$	2.0	125
Water to make	4 liters	

Minor elements:

$\text{MnCl}_2 \cdot 4 \text{H}_2\text{O}$	2500 mg	
$\text{H}_3\text{BO}_3$	2000	
$\text{ZnSO}_4 \cdot 7 \text{H}_2\text{O}$	50	
$\text{CoCl}_2 \cdot 6 \text{H}_2\text{O}$	30	
$\text{CuCl}_2 \cdot 2 \text{H}_2\text{O}$	15	
$\text{Na}_2\text{MoO}_4 \cdot 2 \text{H}_2\text{O}$	25	
Water to make	1000	Use 0.5 ml per liter of final medium

2. Knop's Solution (X 2, dilute 1:1)

Major elements:

$\text{Ca}(\text{NO}_3)_2 \cdot 4 \text{H}_2\text{O}$	4.0
$\text{KNO}_3$	1.0
$\text{MgSO}_4 \cdot 7 \text{H}_2\text{O}$	1.0
$\text{KH}_2\text{PO}_4$	1.0
Water to make	4 liters

Minor elements:

Use same composition as Knudson's solution, i.e. 0.5 ml per liter

3. White's Salt Solution (White, 1963)

	Stock	Final concentration
$\text{Ca}(\text{NO}_3)_2$	2.0 gm/l	200 mg/l
$\text{Na}_2\text{SO}_4$	2.0	200
$\text{KNO}_3$	0.8	80
KCl	0.65	65
$\text{NaH}_2\text{PO}_4$	0.165	16.5
$\text{MgSO}_4$	36.0	360
$\text{MnSO}_4$	0.45	4.5
$\text{ZnSO}_4$	0.15	1.5
$\text{H}_3\text{BO}_3$	0.15	1.5
KI	0.075	0.75
$\text{CuSO}_4$	0.002	0.02
$\text{Na}_2\text{MoO}_4$	0.021	0.21
$\text{Fe}_2(\text{SO}_4)_3$	0.25	2.5
Glycine	0.3	3.0
Thiamine	0.01	0.1
Pyridoxine	0.01	0.1
Nicotinic acid	0.05	0.5

White's solution is generally used to start new materials in tissue cultures. This composition has been modified and at times is referred to Modified White's solution.

Tobacco tissues are used for a number of tissue culture investigations; Murashige and Skoog (1963) developed a salt solution in which tobacco tissue cultures grow and maintain an active growth rate. Various modifications have been made.

4. Murashige and Skoog Medium (Modified)

	Final concentration
$\text{NH}_4\text{NO}_3$	1650 mg/l
$\text{KNO}_3$	1900
$\text{CaCl}_2 \cdot 2 \text{H}_2\text{O}$	440
$\text{MgSO}_4 \cdot 7 \text{H}_2\text{O}$	370
$\text{KH}_2\text{PO}_4$	170
$\text{FeCl}_3 \cdot 6 \text{H}_2\text{O}$	1.5
$\text{H}_3\text{BO}_3$	6.2
$\text{MnSO}_4 \cdot 4 \text{H}_2\text{O}$	22.3
$\text{ZnSO}_4 \cdot 4 \text{H}_2\text{O}$	8.6
KI	0.83
$\text{Na}_2\text{MoO}_4 \cdot 2 \text{H}_2\text{O}$	0.25
$\text{CuSO}_4 \cdot 5 \text{H}_2\text{O}$	0.025
$\text{CoCl}_2 \cdot 6 \text{H}_2\text{O}$	0.025
Glycine	3.0
Niacin	0.5
Thiamine HCL	0.1
Pyridoxine HCl	0.1
Myo-inositol	10.0
Sucrose	30 gm/l
Indoleacetic acid (IAA) and kinetin both at $1 \times 10^{-6}$ M	



SECTIONING AND STAINING PROCEDURES  
FOR PLANTS

Fixation:

Formalin acetic alcohol (FAA) or acetic alcohol shall be used.

Dehydration:

Dehydration shall be accomplished through the tertiary-butyl alcohol series (TBA series). The following sequence is recommended.

Materials shall be washed in water to remove all fixative 30-60 minutes.

50%	ethyl alcohol	
70%	"	
80%	"	20-30 min.
95%	"	

95%	EtOH + TBA	in 3:1 proportion	--	20 min.
"	"	1:1	"	"
"	"	1:3	"	"

Pure TBA -- 2-3 changes " each.

Infiltration:

In the meantime, fresh paraffin shall be melted, put in vials, and allowed to solidify. The material which is now in TBA shall be poured on top of the solidified paraffin in the vial and placed in a 55°C oven.

The paraffin will melt from the bottom upwards, and as this happens the material which is lying on the top shall move to the bottom. Infiltration of paraffin shall take place in this process. -- 45 min. to 2 hours.

Material shall now be transferred to fresh melted paraffin -- there shall be at least 2 changes to ensure the removal of TBA.

Embedding:

Paper boats or appropriate containers shall be made. The fresh paraffin shall be poured with the material. The material shall be arranged according to the plane of sectioning. All these procedures shall be done in quick succession before the paraffin solidifies. After

solidification, the paraffin shall be cut into square or rectangular blocks.

Sectioning:

Paraffin ribbons shall be prepared using a rotatory microtome.

Mounting:

Paraffin ribbons shall be mounted on slides coated with adhesive.

Staining and making final preparations:

Paraffin shall be removed from slides by dipping in xylol at least 2 times. For plant materials, a double stain procedure using safranin and fast green OR safranin and Teriffeld's haemotoxylin is recommended. After staining and destaining, depending on the nature of the stain, the slides shall be made permanent. The slides shall be observed microscopically for histological features.

Reference:

Jensen, W. A. 1962. Botanical Histochemistry, W. H. Freeman & Co.

Johanssen, D. A. 1940. Plant Microtechnique, McGraw Hill, New York.

Aceto carmine:

Glacial acetic acid	45 ml.
Distilled water	55 ml.
Carmine, alim lake	2 gm.

Acetic acid and water shall be combined and brought to a boil. The solution shall be cooled slightly. Carmine shall be added very slowly (thus preventing foaming). The solution shall be gently heated for 30 minutes, preferably using a reflux condenser. It shall be shaken well and filtered.

Acetic orcein:

1 gm. natural orcein shall be dissolved in 45 ml. of hot glacial acetic acid. When cool, 55 ml. of distilled water shall be added. The solution shall be shaken well and filtered.

Acid alcohol:

95% ethyl alcohol	99 ml.
Conc. HCl	1 ml.

Adhesive for fixing paraffin slides to slides:

Knox gelatine	1 gm.
Distilled water	100 ml.
Glycerin	15 ml.
Phenol or thymol	1 gm.

The solution shall be heated to 30°C to dissolve the gelatin and then filtered through cheese cloth.

Formalin acetic alcohol (FAA):

50% or 70% alcohol	90 ml.
Formalin (40%)	5 ml.
Glacial acetic acid	5 ml.

Acetic alcohol:

95% ethyl alcohol      75 ml.  
Glacial acetic acid    25 ml.

Colchicine:

0.2% or 0.5% solutions shall be made  
by dissolving colchicine in water.

Fast Green:

1 gm. fast green shall be dissolved  
in 100 ml. of 95% EtOH.

Feulgen stain:

1 gm. basic fuchsin shall be dissolved by pouring  
into 200 ml. of boiling water. Foaming shall be  
avoided. It shall be shaken well and cooled to  
50°C. After filtering, 20 ml. of 1N HCl shall be  
added to the filtrate. The solution shall be cooled  
to room temperature and 1 gm. of anhydrous sodium  
bisulfite or potassium metabisulfite added. It  
shall be filtered into a brown bottle and allowed to  
stand for 24 hours. 1 gm. activated charcoal shall  
be added. The solution shall be shaken well and  
filtered. It shall be kept in a tightly closed  
brown bottle or covered with aluminum foil to pre-  
vent decomposition by light.

Delafield's Haematoxylin

Commercially available

Phloroglucinol:

Commercially available

Safranin:

1 gm. shall be mixed in 100 ml. of 70% alcohol.  
It shall be filtered if necessary.

Reference:

Johanssen, D. A. 1940. Plant Microtechnique, McGraw  
Hill, New York.

#### GENERAL PROCEDURE FOR USING GEL ELECTROPHORESIS AND ENZYME ASSAYS

Abnormal plants shall be assayed on gel electrophoresis to determine the type of change that has occurred. Previous studies indicate that infected plants respond to the invasion of a pathogen. Several enzymes, particularly peroxidase, increase in activity and number of isozymes. By means of gel electrophoresis, the isozymes of certain enzymes can be assayed. The general procedure shall be as follows:

1. Plant tissue shall be ground with a mortar and pestle or with a pirie press at cold temperatures.
2. After high centrifugation, the protein sample (200 ug) shall be placed on top of the acrylamide gel.
3. After electrophoresis the gels shall be stained for protein patterns and assayed for enzyme activity on the gels.
4. The changes observed shall be evaluated in a densitometer.

#### REFERENCE

Davis, 1963. New York Academy of Science 121: 405.

## GEL SYSTEMS FOR PROTEINS

Electrophoresis at pH 4.5<sup>a</sup>  
for basic proteinsElectrophoresis at pH 8.7<sup>b</sup>  
for acidic proteinsI. Stock Solutions<sup>c</sup>

A. KOH, 1N	24	ml
Acetic acid	8.6	ml
TEMED <sup>d</sup>	2.0	ml
Urea	24	g
Water, to 50 ml		
B. KOH, 1N	24	ml
Acetic acid	1.44	ml
TEMED	0.23	ml
Urea	24	g
Water, to 50 ml		
C. Acrylamide (Eastman)	6.65	g
MBA <sup>d</sup>	0.1	g
Urea	24	g
Water, to 50 ml		
D. Acrylamide	2.5	g
MBA	0.625	g
Urea	24	g
Water, to 50 ml		
E. Riboflavin	1.0	mg
Urea, 8M	50	ml

A. Tris <sup>d</sup>	6.05	g
HCl, 1N	8	ml
TEMED	0.09	ml
Urea	24	g
Water, to 50 ml		
B. Tris	1.50	g
HCl, 1N	12	ml
Urea	24	g
Water, to 50 ml		
C. Acrylamide	7.5	g
MBA	0.2	g
K <sub>3</sub> Fe(CN) <sub>6</sub>	3.75	mg
Urea	24	g
Water, to 50 ml		
D. Acrylamide	3.33	g
MBA	0.83	g
Urea	24	g
Water, to 50 ml		
E. Riboflavin	2.0	mg
Urea, 8M	50	ml

II. Other Reagents

- Ammonium persulfate, made up fresh daily, 1.12% in 8M Urea
- Buffer; stock soln., store at 3°  
B-Alanine 31.2 g  
Acetic acid 8.0 ml  
Water, to 1 liter; adjust to pH 4.5
- Urea, 8M

- Ammonium persulfate, made up fresh daily, 0.56% in 8M Urea
- Buffer; stock soln., store at 3°  
Tris 6.0 g  
Glycine 28.8 g  
Water, to 1 liter; adjust to pH 8.2 - 8.4
- DMAP<sup>d,e</sup>, 10% in water
- Urea, 8M

III. Gel Preparations

- Lower Gel:  
Mix: 1 part A  
6 part C  
1 part Ammonium persulfate

- Lower Gel:  
Mix: 3 part A  
4 part C  
1 part Ammonium persulfate

## 2. Upper Gels (spacer and sample):

Mix: 1 part B  
 4 " D  
 1 " E  
 2 " Urea, 8 M  
 (Add 1  $\mu$ l DMAPN per ml of gel)  
 Not needed

## 2. Upper Gels (spacer and sample):

Mix: 2 parts B  
 3 " D  
 1 " E  
 2 " Urea, 8 M  
 Add 1  $\mu$ l DMAPN per ml of gel

<sup>a</sup>Modified from R.A. Reisfeld, U.J. Lewis and D.E. Williams, Nature 195; 281, 1962.

<sup>b</sup>Modified from B.J. Davis, reprint obtained from Distillation Products Inc., 1961.

<sup>c</sup>Store in amber plastic bottles at 3°. Include a magnetic stirring bar in those stock solutions (C and D) which tend to crystallize out at 3°.

<sup>d</sup>Tris - trishydroxymethylaminomethane, (Fisher Reagent)

TEMED N,N,N',N - tetramethylethylenediamine, (Eastman, Reagent grade).

MBA -  $\bar{N}$ ,N' - methylenebisacrylamide, (Eastman, Crystallized Reagent).

DMAPN - 3-Dimethylaminopropionitrile, (Eastman, Reagent grade)

<sup>e</sup>The DMAPN is added to facilitate polymerization of the upper gels, which is otherwise particularly difficult in the case of the pH 8.7 upper gel, perhaps because of the omission of the TEMED from B.

<sup>f</sup>The % polymer in the gels as formulated are: lower gel, pH 4.5 - 10%; upper gel, pH 4.5 - 2.5%; lower gel, pH 8.7 - 7.5%; upper gel, pH 8.7 - 2.5%.

## PROCEDURES

1. The procedures, with some modification follow those of Reisfeld, et al., Nature 195; 281, 1962. The runs are made in glass tubes, 3.25 inches long and with an I.D. of 5 mm. The volumes of gel solutions for the various layers are: 1.0 ml for the lower gel layer, 0.1 ml for the spacer gel layer and 0.15 ml for the sample gel layer. Each gel layer is overlaid with water to hasten polymerization.

2. Fifty to 100  $\mu\text{g}$  of basic protein is generally run in a volume of 10 to 20  $\mu\text{l}$ .\* Considerably more protein can be run, although some of the closely running bands begin to run together and cannot be distinguished. Up to about 50  $\mu\text{l}$  of solution can be tolerated before the presence of LiCl begins to interfere with formation of the Kohlrausch boundary and resolution is lost.
3. The electrophoretic runs are carried out at 3<sup>o</sup> for optimum resolution. For the run at pH 4.5 the stock buffer is diluted with 4 parts of cold water, the run is carried out for 90 to 120 mins. with the cathode at the bottom and a current of 3 ma/tube. A trace of a 0.1% solution of pyronine red (National Aniline; Allied Chemical) is applied to the top of the sample gel after it has been polymerized to provide a tracking dye indicating the solvent front. A 90 to 120 min. run will move the dye band to the base of the tube.\*\* Shorter runs can be achieved with lower dilutions of the buffer, but it is not advisable to increase the current, as heating will occur and lower the resolution. For the run at pH 8.7 the stock buffer is diluted with 1 part of cold water; the run is carried out as above with the anode at the bottom, and bromphenol blue used as the tracking dye.
4. At the conclusion of the electrophoretic run the gel columns are removed from the glass tubes by first rimming with water and are then stained for at least 1 hour by immersion in a 1% solution of Amido Schwarz in 7.5% acetic acid. Destaining is carried out overnight at room temperature at a current of 4 to 5 ma/tube with the anode at the bottom and 7.5% acetic acid in the buffer trays.

---

\* Better separation can be obtained if sample is dialyzed free from salts, but some protein aggregates in the absence of salts.

\*\* Need 3-4 hours.



ENZYME ASSAYS FOR GEL ELECTROPHORESIS

I. PEROXIDASE

A. Compounds

1. 0.01 M Guaiacol
2. 0.3% H<sub>2</sub>O<sub>2</sub>

B. Procedure

1. Incubate gels in guaiacol for at least 20 min.
2. Rinse with distilled water.
3. Add H<sub>2</sub>O<sub>2</sub>

II. ACID PHOSPHATASE

A. Compounds

- |                               |         |
|-------------------------------|---------|
| 1. 0.05 M acetate buffer pH 5 | 10.0 ml |
| 2. GBC (diazo-garnet)         | 10.0 mg |
| 3. Alpha-naphthyl-phosphate   | 10.0 mg |

B. Procedure

Incubate gels at room temperature.

III. MALIC DEHYDROGENASE

A. Compounds

- |  |         |
|--|---------|
| 1. 0.05 M tris-HCl buffer pH 7.5         | 7.5 ml  |
| 2. 0.50 M malic acid pH 7.5              | 3.0 ml  |
| 3. 0.06 M KCN pH 7.5                     | 1.25 ml |
| 4. NBT (nitro-blue tetrazolium 2 mg/ml)  | 3.50 ml |
| 5. DPN (diphosphopyridine nucleotide)    | 10.0 mg |
| 6. PMS (phenazine methosulfate, 2 mg/ml) | 0.15 ml |

B. Procedure

Mix and incubate in the dark.

#### IV. MALIC DEHYDROGENASE (alternate procedure)

##### A. Compounds

1. 0.014 M tris-HCl buffer pH 8.3	7.0 ml
2. 0.10 M malic acid (sodium salt) pH 8.3	3.0 ml
3. NBT	8.0 mg
4. DPN	3.0 mg
5. PMS	1.4 mg

##### B. Procedure

1. Rinse gels in cold tris buffer at pH 8.3.
2. Incubate 0.5 to 4 hours at 37°C.

#### V. REFERENCES

Goldberg, E. and J. N. Cather. 1963. Molecular heterogeneity of lactic dehydrogenase during development of the snail. *J. Cell. and Comp. Physiol.* 61, 31-38.

## VIROLOGY APPENDIX

Gradient Density Centrifugation

A refinement in technique which has increased the resolving power and the purification potential of the ultracentrifuge enormously is density-gradient centrifugation. This method makes possible the separation and the zoning of particles of different sizes or densities by sedimenting them through a liquid column of positive (i.e., increasing with depth) density gradient.

Gradients may be formed before or during centrifugation. The solutes usually used for the preparation of preformed gradients are sucrose or glycerol. Such gradient columns can be constructed in a highly reproducible fashion by a gradient-producing engine which introduces two solutions of different densities (e.g., water and 40% aqueous sucrose solution) into a centrifuge tube at differential rates or, more simply, by layering discrete volumes of solutions of successively lower concentrations of sucrose on top of one another with a pipette. The discontinuous gradient produced by layering will become smooth and relatively uniform by diffusion during a period of 12 to 24 hours, depending on the width of each layered solution.

In order to establish a density gradient during centrifugation, solutions of high concentrations of heavy salts such as cesium chloride, rubidium chloride, or potassium bromide are employed. The gradient is formed as the result of the partial sedimentation of these solutes during centrifugation. The classes of particles to be separated may be distributed throughout the gradient column or layered as a concentrated solution in a small volume on top of the column prior to centrifugation.

There are essentially two approaches to the fractionation of virus and subcellular particles by density-gradient centrifugation. One is to separate particles on the basis of their sedimentation rates and the other primarily on the basis of their densities. In the former method, a concentrated, partially purified virus suspension is layered on top of a preformed sucrose or glycerol gradient and centrifuged in a swinging bucket rotor. Each class of particles will sediment as a separate zone at rates which depend on particle size, shape, and density. When, after an appropriate length of time of centrifugation, the zones are resolved in the gradient column, the plastic centrifuge tube is removed from the rotor, illuminated with a beam of light in order to make the light-scattering zones visible, and the fractions collected by any of several sampling devices. If centrifugation of the above system is permitted to continue long enough, the different classes of particles will sediment as zones which will finally come to rest at levels in the gradient column corresponding to their own densities.

#### Concentration of Viruses on Aluminum and Calcium Salts

Preparation of precipitates. Aluminum phosphate. Ten ml of 2 M  $\text{Na}_2\text{HPO}_4$  were slowly added to 100 ml of 25mM  $\text{AlCl}_3$  (pH 7.2 should be reached and maintained). The mixture was kept constantly stirring during the preparation and for 15 minutes thereafter. The precipitate was then centrifuged at 2000 rpm for 15 minutes and the supernatant fluid discarded. The sediment was suspended in 0.15M NaCl and again centrifuged. The supernatant fluid was again discarded, and the sediment resuspended in saline and autoclaved at

15 lbs. pressure for 15 minutes. After cooling and centrifugation, the sediment was resuspended in 110 ml of sterile saline. The precipitate was stored at 4°C in this form until used. Immediately before use the suspension was mixed, the amount required for the test (multiples of 2.7 ml) was centrifuged, and the sediment resuspended in the buffer required for the test using the same volume as that of the supernatant. After mixing, 2.7 ml. volumes of the suspension were distributed in 13 x 100 mm tubes.  $\text{AlPO}_4$  when used as described above contained 0.4 gram of packed sediment suspended in 2.7 ml buffer. Viruses in 0.3 ml volumes were then added to each 2.7 ml of suspension. During an incubation period, usually of 30 minutes, the tubes were inverted occasionally to increase the collision efficiency of virus and precipitate. The samples were then centrifuged at 2000 rpm for 5 minutes, the supernatant removed, and the sediment resuspended in 3 ml of buffer as indicated under "Results". Supernatant fluids and resuspended precipitate were then directly titrated for virus activity. The resuspended salt was not toxic for the cell systems used for assay even when inoculated without further dilution.

Aluminum hydroxide. Three ml of 2 M  $\text{Na}_2\text{CO}_3$  were added to 100 ml of 25mM  $\text{AlCl}_3$  and the precipitate treated as described above. The procedure for use of aluminum hydroxide was also the same as that described for aluminum phosphate.

Calcium phosphate. Equal volumes (50 ml) of 0.02 M  $\text{CaCl}_2$  and 0.02 M  $\text{Na}_2\text{HPO}_4$  were mixed together, and then the precipitate was washed with saline and processed as described for the above salts.

The following procedure was used to concentrate each virus sample. Five ml of aluminum hydroxide (0.25 ml of packed precipitate) suspended in pH 6

buffer was added to a liter of the diluted virus. The mixture was allowed to stir gently on a magnetic unit for one hour at 25°C. It was then filtered by negative pressure through a 47 mm HA Millipore filter pad (0.45 $\mu$  porosity). The trapped precipitate, recovered from the filter pad with the aid of a platinum spatula, was suspended in 1 ml of saline. This suspension was inoculated in 0.1 ml amounts into each of 10 bottles, cultures and an overlay added as described under "Methods." Two control virus samples, one containing the original virus at estimated concentration of 100 PFU/ml and the second containing the virus diluted 1000-fold, were also inoculated into 10 cultures.

Smith, K. O. and J. L. Melnick, 1962. Electron Microscopic Counting of Virus Particles by Sedimentation on Aluminized Grids. *The Journal of Immunology*. 89:279-284.

Preparation of electron microscope grids for particle counting. Steel grids were coated with collodion membranes prepared in the following way. A solution of 0.75% collodion in amyl acetate was dropped on a small block of 2% agarsaline, allowed to drain dry, and the membrane stripped in distilled water and mounted on several steel 200 mesh electron microscope grids simultaneously. They were dried, transferred to a flat surface, and coated with a very small amount of aluminum. One milligram of aluminum was evaporated from a tungsten basket placed approximately 17 cm from the specimens, which were canted at an 18° angle with the aluminum source. These membranes were extremely tough, withstanding high speed centrifugation, washing under a fast moving stream of water, and repeated handling without breaking.

Particle counting. The Spinco SW-25.1 swinging bucket rotor was fitted with lucite chambers as described recently by Smith and Benyesh-Melnick (12) for counting polyoma virus. To facilitate handling grids, flat lucite disks were inserted into the bottoms of the chambers in the place of the agar previously used for pseudoreplication counting. Aluminized grids were placed on these disks and the virus suspension was appropriately diluted in distilled water and placed in the cup while the grids were held in place. The fluids were then centrifuged at maximum speed (25,000 rpm) for 1/2 hr for poliovirus and 20 minutes for bacteriophage and vaccinia. After centrifugation, the supernatant fluid was removed by capillary pipet, the chamber removed, and the grids recovered for further treatment. Grids remained in place near the center of the bottom of the chamber during centrifugation. As will be described, some grids were washed with distilled water. Grids with poliovirus were shadowed with chromium and examined in the electron microscope. Bacteriophage and vaccinia preparations were dipped for 1/2 minute in 0.5% uranyl acetate, then examined. Five photomicrographs were made of random fields on a single grid and these were counted and averaged for each determination. The calculation of the number of particles/milliliter of the original virus suspension was done in the following way:

Particles/ml =

Reciprocal of column height in cm X  
 Reciprocal of unit area counted in cm X

Particles counted per unit area X  
 Reciprocal of dilution X 1.07

(1.07 - factor accounting for radial spread of sedimenting particles.)

### Virus Isolation Techniques

Two different techniques were used in attempting to find progeny of vaccinia virus circulating in the blood of the vaccinees. The first method involved conventional virus isolation procedures, with 1 ml of each undiluted serum being inoculated directly onto monolayers of MK cells in three 1 oz. bottle cultures. The cultures were observed over a 14-day period for cytopathic effect (CPE), and positive cultures were harvested when 50 per cent of the cells showed CPE; these were frozen at  $-20^{\circ}\text{C}$  to await typing of virus and genetic marker tests. Virus detected in the blood by this method will be referred to as "free" virus.

A second method used was based on the observation that infectious virus could be recovered from neutralized mixtures. Mandel, using type 1 poliovirus and a specific hyperimmune antiserum prepared in rabbits, showed that completely neutralized virus could be reactivated by placement of the antigen-antibody mixture in a strongly acid medium (pH 2.5). To test for "bound" virus, the following technique was used. A portion (0.5 ml) of each daily serum sample was placed in each of three 100 X 13 mm tubes. To each tube were added 0.25 ml of acid buffer-gelatin-Tris (as described by Mandel) and 0.20 ml of 0.3 N HCl, both of which had been pre-warmed to  $37^{\circ}\text{C}$ . This brought the pH of the serum to 2.5, where it was maintained at room temperature for 2 hours. The tubes were then returned to pH 7.0 by addition of 0.45 ml of alkaline buffer-gelatin-Tris and 0.20 ml of 0.3 N NaOH to each tube.

After the sera were brought to pH 7.0, 0.3 ml of each sample was inoculated onto each of 5 MK tube cultures from which the M-E maintenance medium had been



drained. The tubes were incubated at 37°C for 2 to 3 hours in a stationary rack, covered by aluminum foil. The monolayers were then rinsed gently twice with 1.0 ml of fresh M-E medium, and a third 1.0 ml of medium was left in each tube. Tubes were stoppered, reincubated at 37°C for one week, and observed at least every other day for CPE. Positive tubes were harvested and stored frozen as soon as 50 per cent of the cells showed CPE.

Controls on the sensitivity of this modified acid-dissociation procedure were carried out using all three types of virus in the poliovaccine and in the virulent MEF1 strain of type 2 poliovirus. They were tested against the reference polio antisera prepared in monkeys for the National Foundation and since transferred to the National Institutes of Health. Stock viruses were titrated and aliquots containing 100 TCD<sub>50</sub> per 1.0 ml were combined with equal fluid quantities of the homotypic antisera. These mixtures were incubated at 37°C for 6 hours and then placed at 4°C overnight. Samples of 0.5 ml each of a control virus-antibody system were included in each test. Recovery of a large proportion (over 50 per cent) of the control virus from its neutralized mixtures indicated proper functioning of the test.

Mandel, B. Reversibility of the Reaction Between Poliovirus and Neutralizing Antibody of Rabbit Origin, 1961. *Virology* 14: 316-328.

### Hemadsorption

Certain viral agents multiply in cell cultures without producing clear-cut degeneration, and their presence must be detected by indirect methods. In the case of influenza viruses and the newly recognized group of respiratory viruses designated as the parainfluenza viruses, the fact that they possess hemagglutinins (sites which combine with erythrocytes of certain species) permits their detection by the technique of hemadsorption. For this procedure, a suspension of guinea pig or chicken erythrocytes is added to the infected tissue culture; the hemagglutinins of the virus present in the cell cultures combine with receptors on the erythrocytes; and microscopic examination reveals the erythrocytes adhering in clumps to the host cell monolayer. The hemadsorption technique is employed for recognition of myxoviruses in cell cultures inoculated with clinical materials as well as for identification and neutralizing antibody assays for these viruses.

### Hemagglutination Tests

Serial twofold dilutions of virus suspensions, antigens, or diluents suspected of containing viral agents are made in saline or veronal buffer or phosphate buffers at specific pH levels (using convenient volumes, for instance 0.2 or 0.4 ml). An equal volume of 0.5% or 0.25% erythrocytes (thrice washed in saline) of different animal species, or human O cells, is added to the serially diluted test material. Tests are performed in triplicate, and incubated at three different temperatures: 4°, 25°, and 37°C. Tests are negative for virus when the erythrocytes form a compact red button at the bottom of the tube. Tests are positive for virus when the erythrocytes are agglutinated to form a red, granular diffuse lining of the bowl of the tube.

Tissue Culture MediaCONCENTRATION (MG./LITER) IN

COMPONENTS	MEDIUM NO. 199	EAGLE'S MINIMUM ESSENTIAL MEDIUM	LEIBOVITZ MEDIUM NO. 15 (L-15)	RAPPAPORT'S BASIC SYNTHETIC MEDIUM
<b>Amino acids</b>				
L-Alanine	50*	...	450*	...
L-Arginine	70	105#	500#	60#
L-Asparagine	...	...	250	16
L-Aspartic acid	60*	...	...	...
L-Cysteine	0.1	...	120#	100
L-Cystine	20	24	...	...
L-Glutamic acid	150*	...	...	...
L-Glutamine	100	292	300	280
Glycine	50	...	200	150
L-Histidine	20	31#	250	10#
Hydroxy-l-proline	10	...	...	...
L-Isoleucine	40*	52	250*	300
L-Leucine	120*	52	125	200
L-Lysine	70	58#	75	60#
L-Methionine	30*	15	150*	60
L-Phenylalanine	50	32	250*	90
L-Proline	40	...	...	10
L-Serine	50*	...	200	10
L-Threonine	60*	48	300	60
L-Tryptophan	20*	10	20	5
L-Tyrosine	40	36	300	145
L-Valine	50*	46	200*	170
<b>Vitamins</b>				
p-Aminobenzoic acid	0.05	...	...	...
Biotin	0.01	...	...	0.15
Ca pantothenate	0.01	1.0	1.0	0.10
Choline chloride	0.50	1.0	1.0	1.0
Folic acid	0.01	1.0	1.0	...
i-Inositol	0.05	2.0	2.0	3.5
Niacin	0.025	...	...	...
Niacinamide	0.025	1.0	1.0	0.15
Pyridoxal HCl	0.025	1.0	1.0	...
Pyridoxine HCl	0.025	...	...	0.10
Riboflavin	0.01	0.1	0.1	0.15
Thiamine HCl	0.01	1.0	1.0	0.15
Vitamin A	0.10	...	...	...
Ascorbic acid	0.05	...	...	50
α-Tocopherol phosphate	0.01	...	...	...
Calciferol	0.10	...	...	...
Menadione	0.01	...	...	...
Vitamin B <sub>12</sub>	...	...	...	0.015
Citrovorum factor	...	...	...	2.0

\* Amount of DL form of amino acid rather than L form.

# Free base form.

COMPONENTS	CONCENTRATION (MG./LITER) IN			
	MEDIUM NO. 199	EAGLE'S MINIMUM ESSENTIAL MEDIUM	LEIBOVITZ MEDIUM NO. 15 (L-15)	RAPPAPORT'S BASIC SYNTHETIC MEDIUM
<b>Nucleic acid derivatives</b>				
Adenine	10	...	...	...
Guanine HCl	0.3	...	...	...
Hypoxanthine	0.3	...	...	10
Thymine	0.3	...	...	...
Uracil	0.3	...	...	...
Xanthine	0.3	...	...	...
Adenylic acid	0.2	...	...	...
<b>Carbohydrates</b>				
2-Deoxy-d-ribose	0.5	...	...	...
d-Ribose	0.5	...	...	...
Glucose	1,000	1,000	...	1,000
Galactose	...	...	900	...
<b>Miscellaneous</b>				
Sodium acetate	50	...	...	...
Sodium pyruvate	...	...	550	500
Tween 80 (oleic acid)	5.0	...	...	...
Cholesterol	0.2	...	...	...
Glutathione	0.05	...	...	...
Adenosine triphosphate	10	...	...	...
Phenol red	20	20	10-20	20
<b>Salts</b>				
NaCl	6,800	6,800	8,000	8,000
KCl	400	400	400	200
CaCl <sub>2</sub>	200	200	140	400
MgCl <sub>2</sub> ·6H <sub>2</sub> O	...	200	200	100
MgSO <sub>4</sub> ·7H <sub>2</sub> O	200	...	200	100
NaH <sub>2</sub> PO <sub>4</sub> ·H <sub>2</sub> O	140	140	...	70
Na <sub>2</sub> HPO <sub>4</sub>	...	...	50	60
KH <sub>2</sub> PO <sub>4</sub>	...	...	60	...
Fe(NO <sub>3</sub> ) <sub>3</sub> ·9H <sub>2</sub> O	0.1	...	...	0.4
NaHCO <sub>3</sub>	2,200	2,200	...	1,100-2,200

COMPOSITION OF THREE TISSUE CULTURE MEDIA  
CONTAINING BIOLOGIC SUBSTANCES

COMPONENT	CONCENTRATION (GRAMS PER LITER) IN		
	LY MEDIUM	M-H MEDIUM	M-E MEDIUM
Lactalbumin hydrolysate	5.00	5.00	5.00
Glucose	4.50	1.00	1.00
Yeast extract	1.00	....	....
NaCl	6.80	8.00	6.80
KCl	0.40	0.40	0.40
CaCl <sub>2</sub>	0.20	0.14	0.20
MgSO <sub>4</sub> ·7H <sub>2</sub> O	0.20	0.20	0.20
Na <sub>2</sub> HPO <sub>4</sub> ·12H <sub>2</sub> O	....	0.12	....
NaH <sub>2</sub> PO <sub>4</sub> ·H <sub>2</sub> O	0.14	....	0.14
KH <sub>2</sub> PO <sub>4</sub>	....	0.06	....
NaHCO <sub>3</sub>	1.10	0.35*	2.20#
Phenol red, 1% soln.	1.60ml.	1.60ml.	1.60ml.

LY medium = lactalbumin hydrolysate-yeast extract medium.

M-H medium = Melnick's medium with a Hanks' balanced salt solution base.

M-E medium = Melnick's medium with an Earle's balanced salt solution base.

\* Prepared as a 2.8 per cent stock solution and added at the time of use.

# Prepared as an 8.8 per cent stock solution and added at the time of use.

